



CFM REDUCTION



DIM LIGHT



TOUCH CONTROL



HUSH SYSTEM



TOP PERFORMANCE



LED LIGHT

ELICA'S EXCLUSIVE PLUS FEATURES

The rounded front, beautifully sloping angles and stainless steel finish of Pilato make a striking visual statement. Available in 30" or 36" widths, Pilato features include a powerful 600 CFM blower, halogen lighting with 2 light intensities, dishwasher safe stainless steel microhole filters and multi-function electronic controls with LCD display that deliver convenience and safety.

Designed for standard ducted installation, Pilato can also be installed as a recirculating system using the Recirculating Kit, available as an accessory.

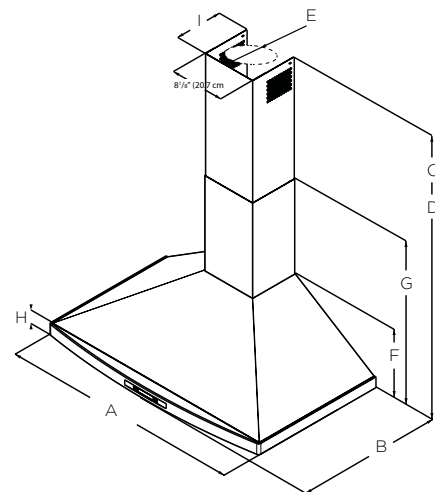

	EPL630S1	EPL636S1
A	30" (76.2 cm)	36" (91.2cm)
B	21 1/2" (54.7 cm)	
C*	Min: 28 7/8 (73.3cm) Max: 42 1/16(106.9cm)	
D**	Min: 28 3/8" (72 cm) Max: 38"(96.6 cm)	
E	6" (15.9 cm)	
F	10" (25.4cm)	
G	24 1/8" (61cm)	
H	1 1/2" (4cm)	
I	7 1/4" (18.4cm)	
J	8 1/8" (20.7cm)	

* Ductless (Recirculating) version ** Ducted version

SPECIFICATIONS



	30" UNIT	36" UNIT
Model:	ELG630S3	ELG636S3
Dimensions:	30" W x 19 11/16" D x 5" H	36" W x 19 11/16" D x 5" H
Blower Type(internal):	600 CFM (4-speed)	
Blower Performance:		
Speed 1	160 CFM	
Speed 2	280 CFM	
Speed 3	470 CFM	
Speed 4	600 CFM	
Noise (sones): Working Speed	Min: 2.03, Max: 8	
Finish:	Stainless Steel	
Controls:	Stainless Steel with black glass	
Illumination:	Touch Control 3 Speeds + Booster	
Filter Type:	2 LED Premium Dimmable Lights, 2.5 w	
Electrical:	120V - 60 Hz 450 Watt at 3.7 Amp	
Installation Type:	Ducted or Recirculating with Recirculating Kit (sold separately)	
Duct Transition:	Top Round 6"	
KITS:		
Recirculating Kit (Contains 6" deflector & 2 Round Carbon Filters)	KIT0141925	
Chimney Extension Kit:	KIT02762	
CONSUMABLE PARTS:		
Charcoal Filter Replacement:	MAT0100812	
Grease Filter Replacement:	GF09PB	
*Consumable parts are sold in units of one (1). Order accordingly		
INSTALL HEIGHTS:		
Ranger Hood:	Ducted - Min: 7'0", Max: 9'2" Recirculating - Min: 7'5", Max: 9'6"	
Ranger Hood with extension duct covers:	Ducted - Min: 8'8", Max: 12'4" Recirculating - Min: 9'0", Max: 12'8"	

PLUS FEATURES



CFM REDUCTION - CFM Reduction System (CRS), is an exclusive feature to Elica hoods, which enables the user directly in the glass touch control the maximum blower CFM, to meet local code requirements.



HUSH SYSTEM - An exclusive sound deadening technology that effectively reduces sound levels by over 35%.



DIM LIGHT - The Dimmer allows you to adjust the brightness of the light as you wish. With Elica, lighting is customized in a discreet, personal and practical way, in order to contribute in creating the perfect kitchen atmosphere.



TOP PERFORMANCE - Excellent performance for models equipped with this plus. High fume capturing capacity with an average aspiration range of 600 CFM's and a noise level between 60-65 db (A) at maximum speed (reference point varies based on the hood category).



TOUCH CONTROLS - Enjoy effortless cooking and fully control each cooking zone with the tip of a single finger.



LED LIGHT - LED lighting is undoubtedly the smartest solution in terms of energy saving. Expected life time of over 20,000 hours, represents the most remarkable advantage of LED light bulbs.