

SOU330X1



| | |
|-----------------|-------------------|
| Category | 30" |
| Product Family | Oven |
| Power supply | Electric |
| Heat source | ELECTRICITY |
| Cooking method | Thermo-ventilated |
| Cleaning system | Pyrolytic |
| EAN code | 8017709204501 |



Aesthetics

| | | | |
|---------------|-----------------|-------------------|--------------------------|
| Aesthetic | Classica | Serigraphy colour | Black |
| Colour | Stainless steel | Serigraphy type | Symbols and wordings |
| Finishing | Fingerproof | Door | With 2 horizontal strips |
| Design | Flat | Handle | Classic |
| Material | Stainless steel | Handle Colour | Inox |
| Type of steel | Brushed | Logo | Embossed |
| Glass Type | Eclipse | | |

Controls

| | | | |
|-----------------|-----------------|-----------------|--------------|
| Control setting | Knobs & buttons | Control knobs | Classic |
| No. of controls | 2 | Controls colour | Steel effect |

Programs / Functions

No. of cooking functions 11

Traditional cooking functions



Static



Circulaire



Turbo



Large grill



Circulaire + grill



Pizza

Other functions



Defrost by time



Defrost by weight



Leavening



Sabbath



Dehydrate

Cleaning functions



Pirólisis

Options



Time-setting options

Delay start and automatic end cooking

Minute minder

Yes

Controls Lock / Child Safety

Yes

Other options

Rapid pre-heating

Keep warm

Yes

Technical Features



| | |
|-------------------------------|--------------|
| Minimum Temperature | 30 °F |
| Maximum temperature | 290 °F |
| No. of shelves | 6 |
| Shelves type | Molded sides |
| N. of fans | 2 |
| No. of lights | 3 |
| Light type | Halogen |
| Light Power | 20 W |
| Light when door is opened | Yes |
| Lower heating element power | 3000 W |
| Upper heating element - Power | 1032 W |
| Large grill - Power | 3500 W |

| | |
|--|-----------------|
| Circular heating element - Power | 1300 W |
| Circular heating element 2 - Power | 1300 W |
| Heating suspended when door is opened | Yes |
| Removable door | Yes |
| Total no. of door glasses | 4 |
| Safety Thermostat | Yes |
| Cooling system | Tangential |
| Door Lock During Pyrolysis | Yes |
| Usable cavity space dimensions (HxWxD) | 410x610x415; mm |
| Temperature control | Electronic |
| Cavity material | Enamel |

Performance / Energy Label



Net volume of the cavity 3.64 cu. ft.

Number of cavities 1

Accessories Included



| | | | |
|--|---|------------------------------|-------------------|
| Enamelled tray (20mm) | 1 | Rack with back and side stop | 2 |
| Insert gird | 1 | Temperature probe | Yes, single point |
| Telescopic Guide rails, total Extraction | 1 | | |

Electrical Connection

| | | | |
|---------------|-----------|---------------------------|----------|
| Voltage | 120/240 V | Current 2 | 17.5 A |
| Current | 16.9 A | Frequency (Hz) | 60 Hz |
| Nominal power | 3535 W | Power supply cable length | 78 3/4 " |
| Voltage 2 | 120/208 V | | |

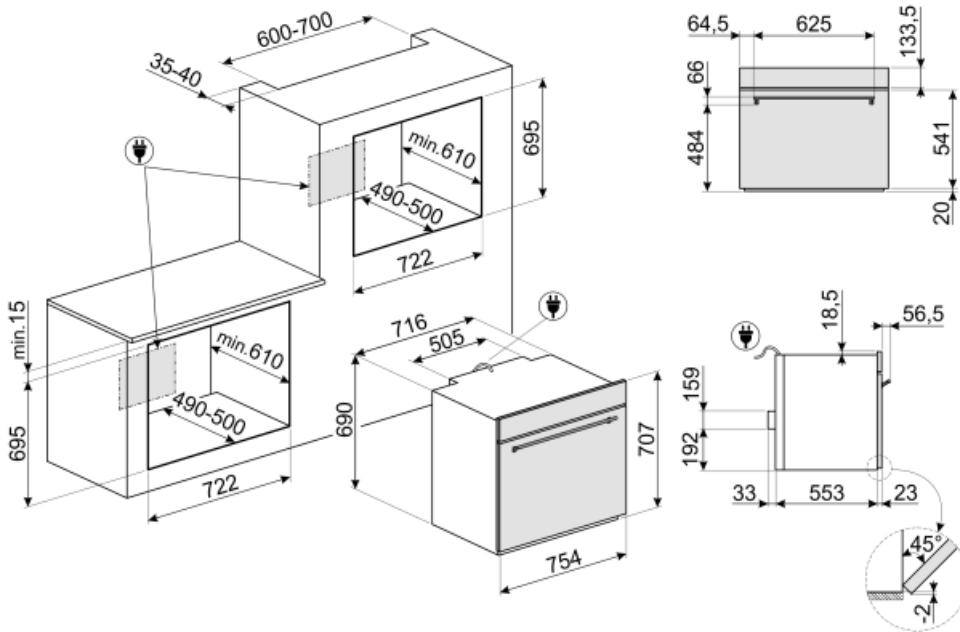



















Not included accessories







STONE

Rectangular refractory stone Ideal for cooking pizzas with the same results as a typical wood-fired oven. Can also be used for baking bread, focaccias and other recipes such as pies, flans or biscuits Dimensions: L42 x H1,8 x P37,5 cm.



Symbols glossary (TT)

| | |
|--|---|
|  <p>Child lock: some models are fitted with a device to lock the programme/cycle so it cannot be accidentally changed.</p> |  <p>Air cooling system: to ensure a safe surface temperatures.</p> |
|  <p>Defrost by time: Manual defrost function. At the end of the set duration, the function stops.</p> |  <p>Defrost by weight: Automatic defrost function. You choose the type of food to defrost from the available categories (MEAT - FISH - BREAD - DESSERTS) After entering the weight of the food, the oven automatically defines the time required for proper defrosting.</p> |
|  <p>Quadruple glazed: Number of glazed doors.</p> |  <p>Electric</p> |
|  <p>Static: Traditional cooking suitable for the preparation of one dish at a time. The fan is not active and the heat comes from below and from above at the same time. Static cooking is slower and more delicate, ideal in order to get well cooked and dry dishes even inside. Ideal for cooking all types of roasts, fatty meats, bread, filled cakes.</p> |  <p>Circulaire + grill: Circulaire with upper element or grill: Similar to fan with upper element with the added cooking speed of circulaire, ideal for dishes with a crispy topping. When used with the grill the food will brown more quickly.</p> |
|  <p>Circulaire: it is the perfect function for cooking all types of dishes in a more delicate way. The heat comes from the back of the oven and is distributed quickly and evenly The fan is active. It is also ideal for cooking on multiple levels without mixing smells and flavors.</p> |  <p>Grill: Very intense heat coming only from above from a double heating element. The fan is not active. Provides excellent grilling and gratinating results. Used at the end of cooking, it gives a uniform browning to dishes.</p> |
|  <p>Pizza function: Specific function for cooking pizza in a pan. It allows to obtain a pizza that is soft inside and crispy outside with the topping perfectly cooked, not dry and not burnt.</p> |  <p>Turbo: the heat comes from 3 directions: above, below and from the back of the oven The fan is active. It allows quick cooking, even on several shelves without mixing the aromas. Ideal for large volumes or foods that require intense cooking.</p> |
|  <p>KEEP_WARM_72dpi</p> |  <p>Side lights: Two opposing side lights increase visibility inside the oven.</p> |
|  <p>PYROLYSIS - AUTOMATIC CLEANING FUNCTION: the oven heats up to a temperature approaching 500 ° C and chars grease and food residues into a fine ash that can be easily wiped off with a damp cloth. At such a high temperature, the door locks automatically for safety, while the temperature of the door remains controlled so it is safe to touch User adjustable function based on the level of dirt present in the oven.</p> |  <p>Temperature probe: with the temperature probe it is possible to perfectly cooking roasts, loins, meat of various cuts and sizes. In fact, the probe improve food cooking, thanks to the precise control of the temperature at the heart of the dish. The core temperature of the food is measured by a special sensor located inside the tip. When the instant temperature reaches the target temperature set by the user, cooking is finished</p> |
|  <p>Air at 40°C provides the perfect environment for proving yeast type dough mixes. Simply select the function and place dough in the cavity for allotted</p> |  <p>Rapid preheating: cooking is preceded by the preheating phase which allows the cooking compartment to reach the set temperature. This option reduces the time by up to 50%.</p> |

-
- | | | | |
|--|---|---|--|
|  | SABBATH: function that allows to cook food respecting Judaism's day of rest provisions. |  | The oven cavity has 6 different cooking levels. |
|  | Telescopic rails: allow you to pull out the dish and check it without having to remove it from the oven entirely. |  | Electronic control: Allows you to maintain temperature inside the oven with the precision 2-3 ° C. This enables to cook meals that are very sensitive to temperature changes, such as cakes, souffles, puddings. |
|  | The capacity indicates the amount of usable space in the oven cavity in litres. |  | ... |