

# SOFIA PROFESSIONAL SERIES 600 48"



CODE ID

48" PROFESSIONAL HOOD

**F6PH48DS1**



Filtering



CFM max 1000



6 LED lamps



Noise Level 75 (dB)



Wall hung installation

## HOOD

Scotch brite stainless steel (AISI 430)  
Heavy Duty Control Panel with Knobs  
4 + 4 Speed Mechanical Control  
LED lighting  
Led 6x1,2 W - 3200 K  
Double fan motors  
1000 CFM  
75 dB sound rating  
Baffle filter

Minimum distance:

- Electric hob 20 1/2" - 52 cm
- Gas hob 24 3/4" - 63 cm

## OPTIONAL ACCESSORIES

F6CK48-12	Chimney cover
FMFIL	Charcoal filter

# SOFIA

48" PROFESSIONAL HOOD

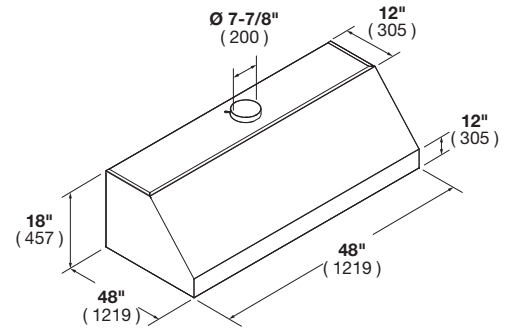

CODE ID	F6PH48DS1 - 48" PROFESSIONAL HOOD	
Series and Finish	600 Series - Professional Design - Stainless Steel (AISI 430)	
<b>CONTROL PANEL</b>		
Control Type	4 speed mechanical control	
<b>PERFORMANCES</b>		
Output (CFM)	1000	
Sound Level (dB)	75	
Motor	Twin Motor	
Venting Type	Ducted and recirculating	
<b>FEATURES</b>		
Filter Style	Pro Baffle	
Lighting	6 x 1.2W LED	
Single duct diameter	7 - 7/8"	(200 mm)
<b>DIMENSIONS/WEIGHT</b>		
Overall dim - Width	47 - 7/8"	(1216 mm)
Overall dim - Height	18"	(460 mm)
Overall dim - Depth	24"	(610 mm)
Gross Weight	90 lbs	(41 kg)
<b>POWER / RATINGS (115 V, 60 HZ)</b>		
Watts / Amps	860W - 7.8A	
Power Cable	Nema 5-15P	
<b>INSTRUCTIONS FOR USE</b>		
Use & Care Manual / Installation Manual	English / French / Spanish	