



CULINARIAN SERIES



USE AND CARE & INSTALLATION GUIDE

GAS SELF CLEAN

GAS MANUAL CLEAN



Proudly
Made in
USA 

Features	3
Models	4-5-6-7
Warnings	8
Safety Practices / Electrical, General	9
Safety Practices / Cooking	10-11
Oven Parts Identification	12
Range Parts Identification	13
Using The Range-Top / Power Burners	14
Using The RangeTop	15-16-17
Using Your Oven	17-18-19-20
Using Your Oven - Self Clean Mode	21-22
Care And Maintenance	23
Care And Maintenance / locating Rating Plate	24
Troubleshooting	25-26
Installation Instructions	27
Table Of Contents	28
Service / Warranty	41



MOST POWERFUL OPEN-TOP BURNERS IN THE INDUSTRY:

All burners are rated at 23,000 Btu / hr to deliver intense commercial kitchen heat to sauté food and all burners are capable of turning down to give 145° F simmer

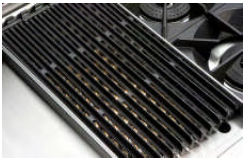

COMMERCIAL QUALITY TRADITIONAL BBQ-GRILL GRATES

The Culinarian Gas Convection Ranges feature our exclusive BBQ-Grill w/ CAST IRON channeling grates that help reduce flare-ups by channeling the grease away from the burner into spillage tray.



HYBRID RADIANTS

With Ceramic Rods Encased in Stainless Steel Sheet Metal for reduced flare-ups and Prolonged life.



THERMO-GRIDDLE

Our solid stainless steel thermostatically controlled griddle plate gives you precise control over the griddle area. From 18,000 BTUs on 12" griddle section and 30,000 BTUs on 24" griddle section Capital all stainless steel griddle plates will never rust! Guaranteed!



ROTISSERIE (SELF CLEAN MODELS ONLY)

Every Culinarian Series gas self clean range features the first ever, motorized rotisserie system in a professional style range. What's more the rotisserie, complete with rod, heavy duty cast stainless steel prongs and basting pan come STANDARD!



FLEX-ROLL OVEN RACKS (SELF CLEAN ONLY)

Our Patented Flex Roll oven racks provide the smoothest, most effortless motion



LARGE OVEN CAPACITY

Large enough to accommodate restaurant size baking tray



Cast Iron Wok Grate As Optional Accessory



STAY-KOOL KNOBS

Our restaurant grade, die cast chrome plated metal knobs feature bold red graphics for easy readings of settings. Plastic inserts that stay cool to the touch when using your Range (Available in Black or Cabernet Red.).



CGSR304

30" CULINARIAN SERIES SELF-CLEAN MODELS

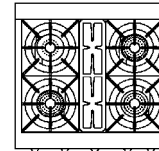

CGSR304



CGMR304

30" CULINARIAN SERIES MANUAL-CLEAN MODELS

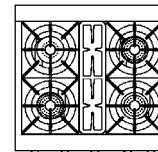

CGMR304



CGSR366



CGMR366

36" CULINARIAN SERIES SELF-CLEAN MODELS

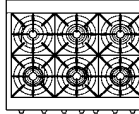

CGSR366

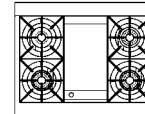

CGSR362G2

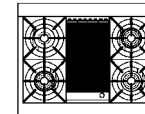

CGSR362B2

36" CULINARIAN SERIES MANUAL-CLEAN MODELS

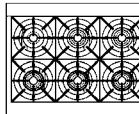

CGMR366

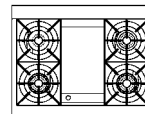

CGMR362G2

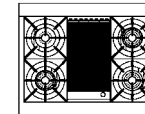

CGMR362B2



CGSR484BG

48" CULINARIAN SERIES SELF-CLEAN MODELS

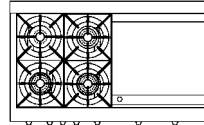

CGSR484GG

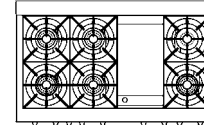

CGSR484G2

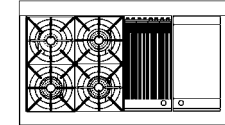

CGSRR484BG

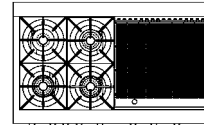

CGSR484BB

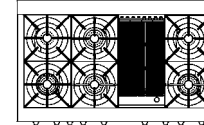

CGSR484B2

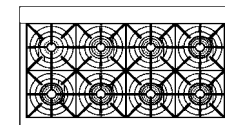

CGSR488

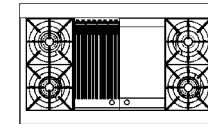

CGSR482BG2



CGMR484BG

48" CULINARIAN SERIES MANUAL-CLEAN MODELS

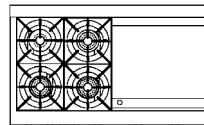

CGMR484GG

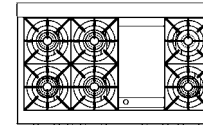

CGMR484G2

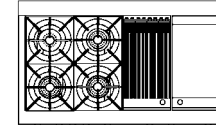

CGMR484BG

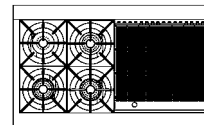

CGMR484BB

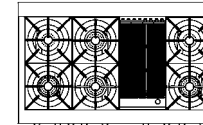

CGMR484B2

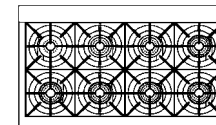

CGMR488

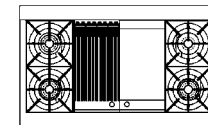

CGMR482BG2



CGSR604GB2

60" CULINARIAN SERIES SELF-CLEAN MODELS

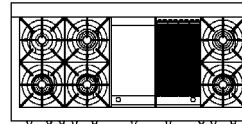

CGSR604GB2

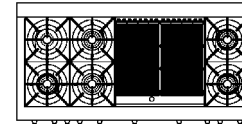

CGSR604BB2

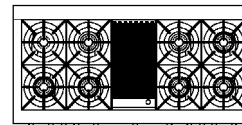

CGSR604B4

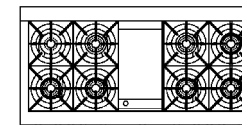

CGSR604G4

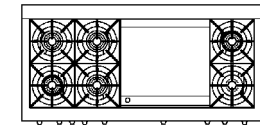

CGSR604GB2

WARNING! If the information in this manual is not followed exactly, a fire or explosion may result causing property damage, personal injury or death.

- WHAT TO DO IF YOU SMELL GAS
- Do not try to light any appliance
- Do not touch any electrical switch
- Do not use any phone in your building
- Immediately call your gas supplier from a neighbors phone. Follow the gas supplier's instructions.
- If you can not reach your gas supplier, call the fire department

Installation and service must be performed by a qualified installer, service agency or the gas supplier.

The appliance and its individual shutoff valve must be disconnected from the gas supply piping system during any pressure testing of that system on test pressures in excess of 5 psi (35 kpa).

The appliance must be isolated from the gas supply piping system by closing its individual manual shutoff valve during any pressure testing of the gas supply

WARNING! Disconnect Power before installing. Before turning power ON, be sure that all controls are in the OFF position.

IMPORTANT! Installation must conform with local codes or, in the absence of local codes, with the National fuel Gas Code, ANSI Z223.1/NFPA54.

IN CASE FIRE

- Smother flames with a close fitting lid, or any metal tray.
- Turn OFF the burner. Be careful to prevent burns. If the flames do not extinguish, immediately evacuate and call the fire department
- NEVER pick up a flaming pan. By doing so, you may be burned.

- DO NOT use water or a wet dishcloth on fire. A violent steam explosion will result. Use a fire extinguisher only if:
 - You have CLASS ABC extinguisher and you know how to operate it.
 - The fire is small and contained in the area where it started.
 - The fire department has been called.
 - You can fight the fire with your back to the exit.

FOR YOUR SAFETY! If You Smell Gas: Shut off gas to the appliance. Extinguish any open flames. If odor persists, immediately call your gas supplier.

This appliance is designed for easy installation and operation. However, we recommend that you read all sections of this manual before installation and that your range is installed by an approved gas installation technician capable of reviewing and performing the manufacturers installation checklist included in your information packet.

The installation of appliances assigned for manufactured (mobile) home installation must conform with the Manufactured Home Construction and Safety and Safety Standard, Title 24 CFR, Part 3280 or, when such standard is not applicable .Refer to

ANSI/NCSBCS A225.1, or with local codes as applicable.

The installation of appliances designed for Recreation Park Trailers must conform with state or other codes or, in the absence of such codes, with the standard for Recreational Park Trailers, ANSI A119.5.

The appliance, when installed, must be electrically grounded in accordance with local codes or, in the absence of local codes, with the National

Electrical Code, ANSI/NFPA 70

WARNING! If the information in this manual is not followed exactly, a fire or explosion may result, causing property damage, personal injury or death. Please read the installation, operating and maintenance instructions thoroughly before use.

CAUTION! When connecting the unit to propane gas, make certain the propane tank is equipped with its own high-pressure regulator in addition to the pressure regulator supplied with the range. The pressure of the gas supplied to the appliance must not exceed 14" (34.57 mB) water column from the propane gas tank to the pressure regulator.

CAUTION! Do not store or use gasoline or any other flammable liquids in the vicinity of this or any other appliance.

PLEASE RETAIN THIS MANUAL FOR FUTURE REFERENCE!

PLEASE NOTE:

In the Commonwealth of Massachusetts, gas connection must be performed by a licensed plumber or licensed gas fitter.

IMPORTANT!: For fire safety and correct operation a back guard must be installed on all ranges prior to use! All ranges are shipped with a standard 3" Island Trim which is compatible with non-combustible back wall installations ONLY! If desired or if the minimum distance to a combustible back wall is not met (see Fig. 2A) one of two additional back guards heights may be ordered and installed (Low Back – 9", or High Back – 18"). Refer to the Installation Instructions accompanying this appliance for assembly instructions

ELECTRICAL SAFETY:

Electrical Requirements and Grounding Instructions

NOTE: ALL MODELS.

IN CASE OF AN ELECTRICAL FAILURE

If for any reason a gas control knob is turned ON and there is no electric power to operate the electronic igniters on the range burners, turn OFF the gas control knob and wait 5 minutes for the gas to dissipate before lighting the range burner manually. To light the range burners manually, carefully hold a lighted match to the burner ports and turn the gas control knob to HI. During a power failure, you can manually light the range burners a match.

Note: The gas oven, grill, Thermo-griddle™ and infrared oven broiler burners **CANNOT** be lit manually during a power failure.

WARNING! Do not under any circumstances cut or remove the separate ground wire or the third (ground) prong from the power cord plug.

PLEASE READ CAREFULLY:

All gas self clean range models require an electrical circuit rated at 120 volts, 60 Hz., and 20 Amps. (VERIFY) For personal safety, this appliance must be connected to a properly grounded and polarized electrical power supply. Always disconnect the electrical plug from the wall receptacle before servicing this unit. See Installation Instructions for electrical requirements and grounding instructions.

It is the personal responsibility and obligation of you, the user, to have this appliance connected to the electrical power supply in accordance with the National Electrical Code and/or applicable local codes and ordinances by a qualified electrician.

*It is recommended that a dedicated circuit servicing this appliance be provided.

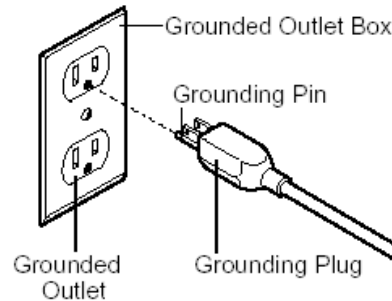

GENERAL SAFETY:

Your new range has been designed to be a safe, reliable appliance when properly installed, used and maintained. If not properly used, it could be dangerous. Read ALL the instructions in this Use and Care Guide carefully before using this range.

WARNING! These precautions will reduce the risk of burns, electric shock, fire, and injury to persons. Use extreme care when using this restaurant caliber range as this appliance provides intense heat and can increase accident potential.

- Safety precautions must be followed when using any kitchen appliance.
- Insure proper installation and servicing. Follow the installation instructions provided with this product. Have the range installed and grounded by a qualified technician.
- Have the installer demonstrate how to use this appliance and show you where the gas supply shut off valve is located so that you know how and where to turn off the gas to the range.

- If you smell gas, your installer has not done a proper job of checking for leaks. If the connections are not perfectly tight, you can have a small leak and therefore smell of faint gas odor. Finding a gas leak is not a "do-it-yourself" procedure. Some leaks can only be found with the burner control in the "ON" position and a qualified service technician must do this.
- In the event a burner goes out and gas escapes, open a window or door immediately. DO NOT attempt to use the range until the gas has had time to dissipate. Wait at least 5 minutes before using the range again.
- DO NOT repair or replace any part of the appliance unless specifically recommended in this manual. All other servicing should be referred to a qualified technician.
- Children SHOULD NOT be left alone or unattended in an area where appliances are in use. They should never be allowed to sit or stand on any part of the appliance.

CAUTION! Do not store items of interest to children over the range or behind it. If children should climb onto the appliance to reach these items, they could be seriously injured.

- NEVER use any part of the range for storage. Flammable materials can catch fire and plastic items may melt or ignite.
- If the range is near a window, be certain the curtains do not blow over or near the range burners, griddle or broiler section; they could catch fire and cause serious damage and injury.
- DO NOT USE WATER ON GREASE FIRES! Turn appliance off and smother fire with baking soda or use a dry chemical or foam-type extinguisher.

- NEVER let clothing, potholders, or other flammable materials come into contact with or too close to any element, burner, or burner grate until it has cooled. Fabric may ignite and result in personal injury.

COOKING SAFETY:

- USE ONLY DRY POTHOLDERS. Moist or damp potholders on hot surfaces may cause burns from the steam. Do not use a towel or other bulky cloth in place of potholders. Do not let potholders touch hot elements, hot burners, or burner grates.
- FOR PERSONAL SAFETY, wear proper apparel. Loose fitting garments or hanging sleeves should never be worn while using this appliance. Some synthetic fabrics are highly flammable and should not be worn while cooking.
- DO NOT use aluminum foil as a shield against food spills or drippings around the burners or control panel area. This could obstruct the flow of combustion and ventilated air. This can damage the finish of the range.

WARNING! This appliance is for cooking! Based on safety considerations, never use the range to warm or heat a room. Such use can damage the range.

- DO NOT TOUCH THE BURNER GRATES OR THE IMMEDIATE SURROUNDING AREAS adjacent to the burners. When in use these areas may become hot enough to cause burns.
- NEVER leave the range unattended when using high flame settings. Boil-overs cause smoking and greasy spills that may ignite. More importantly, if the burner flames are smothered, unburned gas will escape into the room.
- ONLY certain types of glass, heat proof glass-ceramic, ceramic earthenware or other glazed utensils are suitable for range use. Other types of utensils may break with sudden

temperature changes. Use only on low or medium heat settings according to the utensil manufacturer's directions.

- DO NOT HEAT UNOPENED FOOD CONTAINERS. A buildup of pressure may cause the container to burst and cause injury
- DURING COOKING, set the burner control so that the flame heats only the bottom of the pan and does not extend beyond the bottom of the pan.
- USE CAUTION to ensure that drafts like those from forced air vents or fans do not blow flammable materials toward the flames or push the flames so that they extend beyond the edges of the pot.
- TO MINIMIZE ACIDENT, position handles of utensil inward so that they do not extend over adjacent work areas, cooking areas or the edge of the range.
- HOLD THE HANDLE of the pan to prevent movement of the utensil when stirring food.
- DO NOT USE the BBQ grill top section for grilling excessively fatty meats or products that promote flare-ups.
- GREASE IS FLAMMABLE. Let hot grease cool before attempting to handle it. Avoid letting grease deposits to collect. Clean after each use.
- KEEP BURNER PORTS CLEAN. This is essential for proper lighting and maintenance of the burners. It is necessary to clean the burner ports when there is a boil over or when the burner does not light though the electronic igniters click.

- CLEAN THE RANGE-TOP SECTION WITH CAUTION. Avoid steam burns; do not use a wet sponge or cloth to clean the range while it is hot. Some cleaners produce noxious fumes if applied to a hot surface. Follow directions* provided by the cleaner manufacturer.
- BE SURE ALL RANGE CONTROLS ARE TURNED OFF and the range is cool before using any type of aerosol cleaner on or around the range. The chemical that produces the spraying action could, in the presence of heat, ignite or cause metal parts to corrode. Only an authorized service technician should perform Service. Technicians must disconnect the power supply before servicing this unit.
- CLEAN THE VENTILATION HOOD and filters above the range frequently so grease deposits from cooking vapors do not accumulate on them.
- IN CASE OF FIRE or when intentionally using "flaming" liquor or other spirits on the range, follow hood manufacturer's instructions.
- INSTALL A SMOKE DETECTOR in or near the kitchen.
- TURN THE KNOB CONTROL TO OFF if a burner goes out and gas escapes. Open a window or door. DO NOT attempt to use the range until the gas has had time to dissipate.

WARNING! To reduce the risk of tipping of the appliance, it must be secured by a properly installed anti-tip device. Verify that the anti-tip device is engaged per installation instructions (note: anti-tip device is required on all gas ranges.)

SEE PAGE 39

- When using the oven: DO NOT touch the interior surfaces of the oven or the exterior area immediately surrounding the door. Interior oven surfaces become hot enough to cause burns. The heat deflector, which deflects heat away from the range and the trim on the top and sides

- Place oven racks in desired position while oven is cool. If a rack must be removed while the oven is hot, do not let the potholders contact the hot infrared burner.
- Use care when opening the oven door; let hot steam or air escape before removing or replacing foods.
- DO NOT remove the door gasket. It is essential for a good seal during baking.
- BE CAREFUL not to damage the glass covering the infrared broiler in the gas oven. If the glass is damaged, air can enter the distribution box behind the glass, possibly resulting in an explosion.
- In the event that personal clothing catches fire, DROP AND ROLL immediately to extinguish flames.
- DO NOT obstruct the path of combustion or ventilation air.
- For safety reasons and to avoid equipment damage, never sit, stand, or lean on any part of the range.
- Service should only be performed by a qualified, Factory Authorized Service Technician. Technicians must disconnect the power supply before servicing this unit.

CALIFORNIA PROPOSITION 65 WARNING:
The burning of gas cooking fuel generates some by products which are on the list of substances which are known by the State of California to cause Cancer or reproductive harm. California law requires business to warn customers of potential exposure to these substances. To minimize exposure to these substances, always operate this unit according to the instructions contained in this booklet and provide good ventilation to the room when cooking with gas.

1. Remove all packing materials and labels from your appliance. If the installer has not set up your appliance, please do it before using it.
2. Place the oven racks in the proper position before turning on the oven.
For correct rack position, check your recipe. The most frequently used position is number 2. The rack positions are numbered from the bottom to the top as in the floors of a building.

CAUTION! Do not use aluminum foil to cover the oven racks or to line the oven. Heat can be trapped beneath the foil, this can cause damage to the oven and food may not cook correctly.

3. Before BAKING and BROILING
Turn on the oven and broiler burners one at a time for 20 to 30 minutes each. This burns off the manufacturing oils used by the factory. Turn the oven burner on to 450°F and then the broiler burner ON to "Broil". Be sure to turn on the ventilator above your range while these burners are on, as there will be an odor.

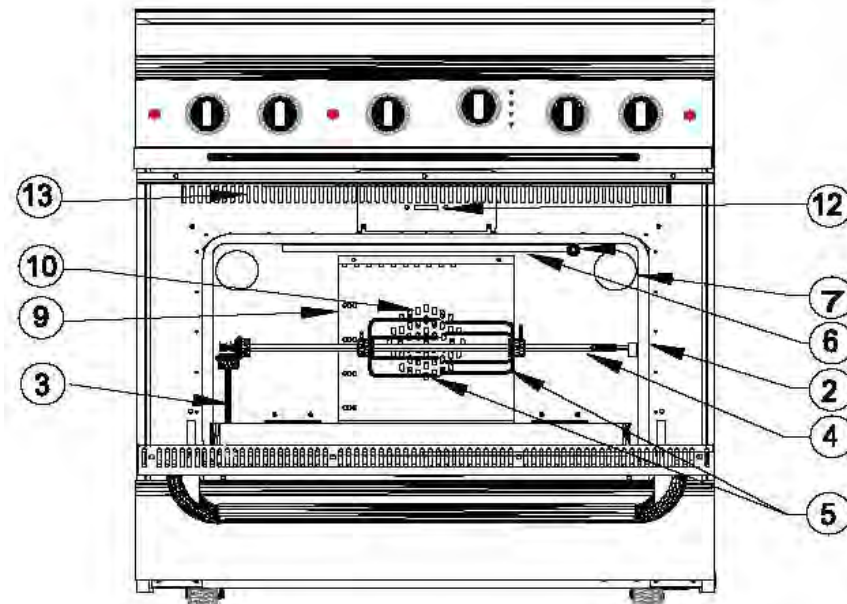
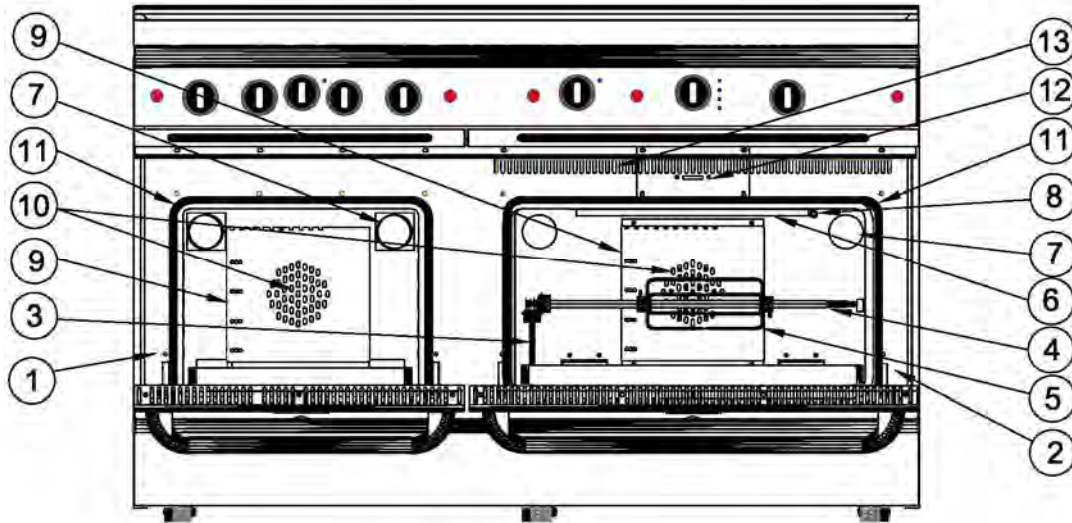

- 1.Small Oven
- 2.Large Oven
- 3.Vertical Rotisserie Rod Support
- 4.Rotisserie Rod
- 5.Meat Holder
- 6.Broiler Burner (behind glass)
- 7.Oven Light
- 8.Oven Thermostat Sensing Bulb
- 9.Convection Baffle
- 10.Convection Fan (center back wall of oven can behind baffle)
- 11.Oven Gasket
- 12.Door Lock (only on self clean models)
- 13.Heat Shield

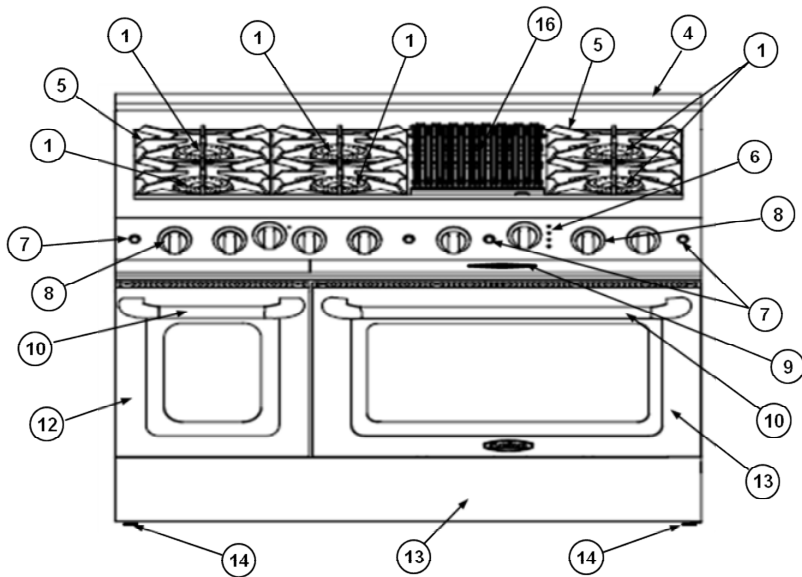
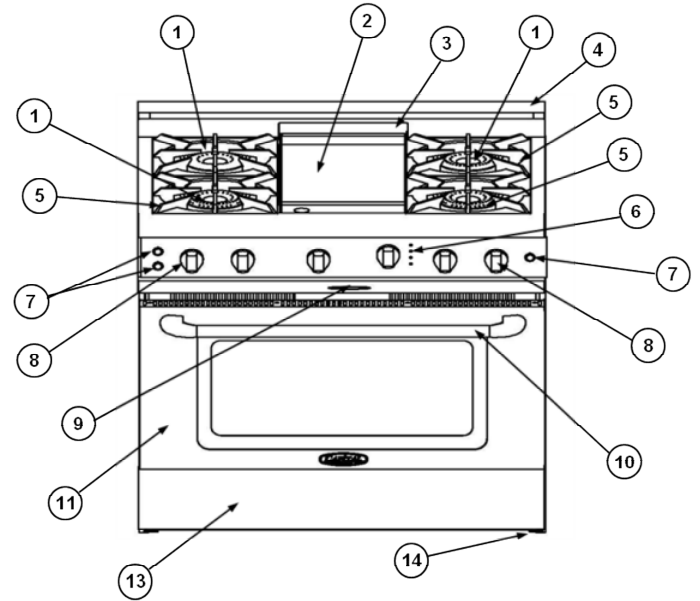
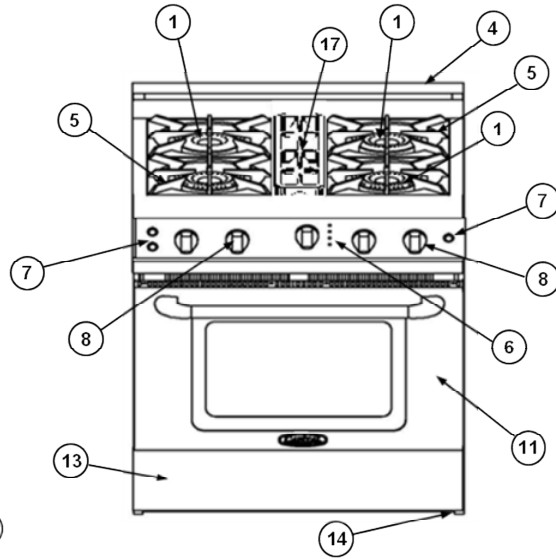
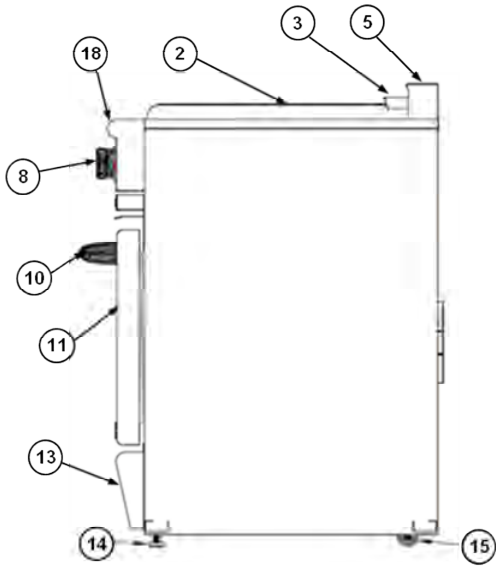

- 1. Burner 23k BTU
- 2. Griddle Plate
- 3. Griddle Flue Cover
- 4. Island Trim
- 5. Cast Iron Grate
- 6. Indicating Lights
- 7. Switch (light, Fan & Rotis)
- 8. Knobs
- 9. Drip Pan Handle
- 10. Oven Door Handle

- 11. Door Panel
- 12. Small Door Panel
- 13. Kick Plate
- 14. Adjustable Leg
- 15. Adjustable Casters
- 16. BBQ Grill
- 17. 30" Center Grate
- 18. Bull Nose

CULINARIAN BURNERS

Your new gas range is equipped with the latest in burner technology. The Culinarian burners are most efficient and most powerful burners (23,000 BTU /HR) in the household appliance industry



All the range-top burners have electronic spark ignition.

SIMMERING BURNERS HAVE

ALL Your new range-top has exceptionally low simmering capabilities

When using the simmer feature, turn the main burner knob down to the simmer position.

ELECTRONIC IGNITERS

If a burner does not ignite, listen for the clicking sound. If the burner does not click, **TURN OFF THE BURNER.** Check the circuit breaker for a blown fuse or a tripped circuit breaker. If the igniter still fails to operate, see page 19 "Troubleshooting", "Before calling For Service".

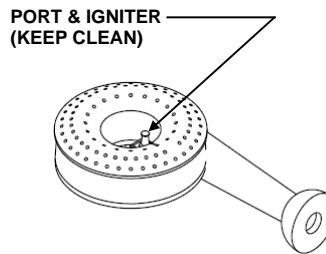

NOTE. If you are using propane gas, a slight pop flash may occur at the burner ports a few seconds after the burner has been turned "off". This "extinction pop" is normal for propane gas.

BURNER EFFICIENCY AND FLAME CHARACTERISTICS

It is necessary to keep the burner ports and the igniters -clean for proper lighting and efficient performance of the range-top burners.

The burner flame should burn completely around the burner with no excessive noise or lifting. The flame should be blue in color and stable with no yellow tips.

An improper air—gas mixture may cause either a burner flutter or a yellow tipped flame. A technician should adjust the flame. During initial use, foreign particles in the gas line, or dust in the air around

the appliance may cause an orange flame. This will disappear with use.

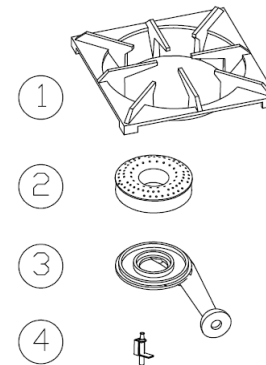

- 1- 82362 GRATE
- 2- 82361-01 23K Btu Burner Head
- 3- 82361-02 Burner Base
- 4- 20652 Electrode Assy

FLAME HEIGHT

The correct height of the flame mainly depends on the size of the bottom of the cooking utensil. Following are some basic rules for selecting flame height.

For safety reasons the flame must never extend beyond the bottom of the cooking utensil. Never allow flames to curl up the side of the pan. You can choose between three different burners.

Utensils which conduct heat slowly (such as glass-ceramic) should be used with medium to low flames. If you are cooking with a large pot, a larger flame can be used.

Proper Flame Height

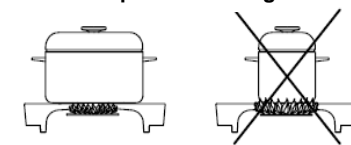

CORRECT

WRONG

BURNER SETTINGS

The rangetop burner valves have infinite settings and there are no fixed positions on the control knobs between HI and SIMMER. To turn the rangetop burner on, push in the control knob and turn it counterclockwise to the "LITE" position. An audible clicking sound will be heard. When the gas has been ignited by the electronic spark igniter, turn the knob to the desired setting.

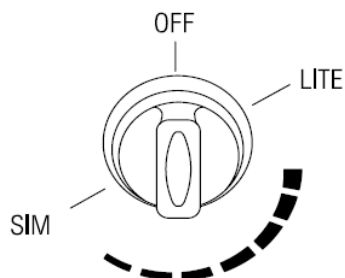

Note: If the Igniter continues to click after the burner has been lit, turn the knob to a setting other than LITE, or HI. If the problem still persists, please call our Service Hotline at 866-402-4600.

CAUTION! When turning on any RANGETOP burner, be sure to stop at the "LITE" position before turning the burner to a flame setting for cooking. If the burner is not lit and it is turned beyond the "LITE" position, to HI, MEDIUM, or LO, there will be a burst of flame when the burner does light. This could cause burns or damage to the surrounding counter top.

BURNER GRATES

The burner grates are a heavy cast iron. They are designed in sections to make them easier to remove and clean.

PROPER COOKING UTENSILS

For best results we recommend using Professional Cookware. These types of utensils can be found at your

finer department stores, specialty cooking shops, or restaurant supply stores. If using regular cookware be very careful if pans have plastic handles, as our Culinarian burners can melt or bubble the handles.

THE CONTROL KNOBS

The control knobs are readily associated with the burners they control. The RANGETOP control knobs are labeled in front of the burners. The oven control is placed slightly higher than the other control knobs. This is due to the physical size of the commercial type thermostats used on the product.

CAUTION!

Use extreme care when placing the grill components into the grill compartment. Avoid hitting the ceramic igniter that could break, preventing operation of the grill.

- Do not leave the grill unattended while in use.
- Do not use charcoal briquettes, ceramic plates, or coals of any kind.

After removing all packaging materials, check to be certain that the grill components are correctly assembled in the grill box. The grill grates and the burner are assembled in the grill box from the factory.

Note: Your grill racks are made of cast iron and enameled

USING THE WOK RING

Wok grate is available as accessory for wok cooking stir-fry this can be placed on any top burner, removing the top grate and placing the wok grate

The Culinarian Wok system is perfectly designed to deliver high intense heat, by spreading the flame under the diameter of the wok pan.

All the range-top burners have electronic spark ignition to eliminate continuously burning pilots. When the main burner flame is blown out, it will relight. Also each burner has its own ignition module. If one module fails all others will continue to work and you are not inconvenienced.

If a burner does not ignite, listen for the clicking sound. If the burner does not click, TURN OFF BURNER. Check the circuit breaker for a blown fuse or a tripped circuit breaker. If the igniter still fails to operate, please call our customer service department at 1-866-402-4600.

Note.

If you are using propane gas, a slight pop or flash may occur at the burner ports a few seconds after the burner has been turned "off". This "extinction pop" is normal for propane gas.

COOKING ON THE GRILL

The burner should light within approximately 45 seconds.

- Preheat the grill for approximately 5 minutes minimum. The hot grill sears the food, sealing in the juices.
- The longer the preheat time, the faster the meat browns and the darker the brand marks.
- Grilling requires high heat for optimum results. High heat is necessary for searing and proper browning. Most foods are cooked at medium heat settings for most of the cooking time. However, when grilling large pieces of meat or

poultry, it may be necessary to turn the heat to a lower setting after the initial browning. This cooks the food through without burning the outside

Foods cooked for a long period of time or basted with a sugary marinade may need a lower heat setting near the end of the cooking time.

After grilling and the food has been removed, turn the knob to HI and burn off any excess grease that may have accumulated on the burner. When cooled, the grill radiants can be turned upside down and heated on high for 10 minutes to burn off any residual fat.

Use a brass wire brush, dipped in hot water, to loosen food particles from the grate.

When the grill has cooled, clean the drip tray and compartment.

GRILLING SUGGESTIONS

- Trim any excess fat from the meat before cooking. FATTY MEATS increase the likelihood of flare-ups. slits in the remaining fat around the edges at (51 mm) intervals.
- Brush on basting sauces towards the end of cooking.
- Add seasoning or salt after grilling. Early salting dries out meat.
- Use a spatula or tongs instead of a fork to turn the meat. A fork punctures the meat and lets the juices flow out.
- After the juices begin to bubble to the surface, turn the meat only once. This helps keep the juices in the meat.
- Some pieces of meat and poultry cook faster than others. Move those pieces to the cooler area of the grill until the rest has cooked.
- The doneness of meat is affected by the thickness of the cut. Chefs say it is impossible to have a rare doneness with a thin cut.

GRILL RACKS

- The grill racks are double sided, two position grates, constructed of Cast Iron. Use the concave side (channels up) for meats of higher fat content (steaks, hamburgers, sausage patties, etc.); use the convex side (channels down) with foods of lesser fat content (fish, vegetables,

WARNING! Do not leave the BBQ section unattended while cooking!

HANDLING EXCESSIVE FLARE-UPS

- The intense heat needed for grilling may also cause flare-ups, due to grease and basting sauces dripping on **the hot radiants**.
- If flare-ups occur, use a long handled spatula to move the food to another area of the grill.
- Should flare-ups become excessive, remove the food from the grill and turn off the burner
- Excessive flames occur when cooking meat with high fat concentration, i.e. 30% ground beef, untrimmed steaks, lamb chops, etc.
- Be cautious when turning meat over, and never PLOP the meat on the grates.

COOKING ON THE THERMO-GRIDDLE

Description:

- The built in griddle is made of non rusting 3/8" thick stainless steel. This produces a surface that is easy to clean and never rusts.
- The griddle has a aluminized steel straight tube burner that is lit by a hot surface igniter. The griddle should pre heat for five to ten minutes.
- A chopping block is available as an accessory and purchased separately. It is sized to fit on top of the griddle surface when Range top is not in use.
- The burner is rated at 18,000 BTU/HR.

CONTROL KNOB

- The griddle is thermostatically controlled with temperatures marked on the knob from 150 degrees F to 500 degrees F
- There are no fixed settings on the knob.

- Press and turn the knob counter-clockwise to the temperature setting.

PREPARING THE GRIDDLE

- The griddle must be level or tilted slightly forward for optimum performance. The griddle should have been leveled during installation.
- **PRIOR TO USE**, It is **NECESSARY** to wash the griddle plate with warm soapy water then rinsed with clear water. The griddle may be used without butter, margarine, or oil. However, a very small amount may be used to flavor foods.

COOKING ON THE GRIDDLE

- Check that the grease tray is tucked under the griddle plate overhang.
- Turn the knob to the cooking temperature to pre-heat the griddle.
- Preheat 5-10 Minutes.
- Add butter, margarine, shortening or oil for more flavor: Add food and cook!

OVEN USE

GENERAL (Only on large self clean oven).

Your large new oven can be used in 5 cooking models convection bake, regular bake, convection broil, regular broil, rotisserie To help you decide which way to cook your food read this information first. Remember this is a new oven and the thermostat has been checked for accuracy. Your old oven had a thermostat that over the years got a little cold. Check your recipes for the correct time and temperature and don't use the old time or temperature you were using to compensate for your old oven being off temperature.

SMALL OVEN REGULAR BAKE ONLY

BURNERS

Your new Culinarian Series™ range is equipped

with bake and broil burners typical of those used in restaurants. The oven broiler burner is 18,000 Btu/hr and the oven baking burner is 30,000 Btu/hr.

ELECTRIC GLOW IGNITER

The oven bake and broil burners are equipped with an electric glow igniter and safety system which lights the gas. There will be a delay after the control knob has been turned on to when you actually hear gas arrive at the burner. The burner will ignite after the gas reaches the burner, sometimes this can take as long as 45 seconds.

USING CONVECTION BAKE AND REGULAR BAKE

TO SET THE OVEN FOR CONVECTION BAKE AND REGULAR BAKE

Decide if you are going to use **CONVECTION BAKE** or **REGULAR BAKE**. These cooking modes are for baking or warming: using one, two, three or four racks. If you are going to use **Regular Bake** turn the oven control knob to the temperature used in the recipe. To use **Convection Bake**, simply press the **CONVECTION** Button located on the front panel to start the Convection Fan.

CONDENSATION

During any cooking process there is a certain amount of moisture that evaporates from the food. The amount of moisture that condenses on the oven depends on the moisture content of the food. The moisture will condense on any surface that is cooler than the inside of the oven, such as the control panel or the top of the door.

CONVECTION BAKE

Convection Bake is baking with a fan at the back of the oven circulating the hot air in a continuous pattern around the food. This circulating hot air heats and browns the surface of the food more effectively than in a standard oven. This allows most foods to be cooked at lower oven temperature or in less time,

if baked at the regular temperature. The air is recirculated and reheated. Uncover, longer cooking foods such as large pieces of meat or other foods that can be cooked in low sided baking utensils or air leavened foods, are where you will see the most savings in cooking time. Using multiple rack at the same time will achieve a good time saving, as you can cook more food at the same time. The number of recipes requiring preheating of the oven is reduced considerably because the heat reaches the food faster as the hot air circulates around the food.

FOODS SUITABLE FOR CONVECTION BAKE

Air Leavened Foods (angel food cake, soufflés, cream puffs, meringue shells)

- Appetizers
- Breads
- Main Dishes
- Oven Meals (1 to 4 racks)
- Cookies
- Pies
- Poultry
- Roasts

CONVERTING RECIPES TO CONVECTION BAKE

Low sided baking utensils will provide the best results, as the hot air can reach all sides of the utensil easier. The oven temperature can be left the same as the recipe and the food cooked a shorter period of time. The temperature can be lowered 25°F to 50°F and the food will probably take the same length of time to cook as the recipe states. If you find that food is adequately browned on the outside, but not done in the center, lower the temperature another 25°F and add to baking time. When reducing the temperature always check the food for doneness, a minute or two before the minimum time stated in the recipe, as time can always be added. Some recipes will cook faster than others. There is no way to predict exactly how long each recipe will take when you convert it to convection.

Convection will be easier to use after you have used

it a few times as you will begin to understand the way it bakes.

SELECTING UTENSILS FOR CONVECTION BAKE

Cooking by convection does not require any specially designed baking utensils. You probably have many utensils in your kitchen that are suitable to use. When choosing a baking utensil, consider the material, the size and shape as they all affect the baking time, the appearance of the finished product.

Metal bake ware (aluminum, steel and cast iron) all result in the fastest cooking time and the best end product. Aluminum pans work best for all types of baked goods. For the best browning, use a pan with a dark or dull finish that absorbs heat, when baking pies and breads. A shiny finish works best for cakes and cookies, since it reflects some of the heat and provides a tenderer surface. Cookie sheets with only one lip will give the best results, as the heated air can circulate all around the sides of the food.

For roasting use bottom of the broil pan and elevate the meat on a metal roasting rack. Glass-ceramic or glass utensils do not conduct heat as well as metal, but they can be used. Use them for foods that do not require a dark brown crust or crisping, such as soufflés.

Baked items cook more quickly and evenly if they are individually smaller in size, i.e. two or three small foods do better than one large piece. When single food items are baked, always center the rack. If several foods are being baked, space them evenly on the racks.

RACK POSITIONS

One to four racks can be used simultaneously during convection baking. Place the rack(s) in the desired position before turning the oven on. Store the unused racks out of the oven.

Rack position 2 (second from bottom) will probably be used the most for single rack convection baking.

When baking on more than one rack you do not

need to stagger the pans. Allow at least 1" of space between the oven walls and the pans so the heated air can circulate. Pans should be placed in the center of the oven, stacked above each rack.

REGULAR BAKE

Bake is baking with hot convected air; with not fan. The air movement comes from natural convection as the air heats, it moves to the top of the oven. This oven mode is the same as you have been using for baking on one or two racks.

FOODS SUITABLE FOR BAKE

- Appetizers
- Pies, Cakes
- Breads
- Desserts
- Main Dishes
- Oven Meals (1 to 2 racks)
- Poultry
- Roasts

CAUTION: Aluminum foil should never be used to cover the oven racks or to line the oven bottom. The trapped heat can damage the porcelain and the heated air cannot adequately reach the food being baked.

RACK POSITIONS

One or two racks can be used simultaneously during bake. Place the rack(s) in the desired position before turning the oven on. Store any unused racks out of the oven.

Rack position 2 (second from bottom) will probably be used the most for single rack baking.

If you are using two racks simultaneously, be sure to check the food on the bottom rack sooner than the minimum time. The food on the lower rack position may cook slightly faster than the food on the upper rack, particularly if you are using large baking utensils so that one is not directly above the other and the heated

at least one inch of space between the oven walls and the pans.

If using large or commercial size baking utensils, the food may take a few extra minutes as the air cannot circulate as freely as it does with a smaller pan. When using commercial size baking utensils, use only one

GETTING THE BEST RESULTS

BAKING:

- Follow the recipe amount and ingredients, including the size and shape of the baking utensil recommended in the recipe.
- Do not open the oven door "just to peek," use the interior oven light and look through the window.
- Do not use the oven for storage, especially when baking in the oven. Extra utensils, not being used for baking, can affect the food product, baking time, browning, and end result.
- If you are using glass utensils, lower the temperature 25°F.
- Use a minute timer and set it for the minimum time suggested in the recipe.

CONVECTION BAKING

- Follow the first three recommendations above.
- Metal utensils give better results, in convection, than do glass baking utensils. If you use glass, it usually is not necessary to lower the temperature an additional 25°F.
- Use a minute timer and set it for less than minimum time suggested in the recipe. The first time you use a recipe in the convection mode, be sure to note the new baking time on your recipe for future reference.

- Be sure to read the basic information on convection before using the oven for the first time, page 14-16.
- Keep in mind that convection baking results vary, depending on type of product.

Notes:

HIGH ALTITUDE BAKING

Recipes and baking times vary if you are baking at high altitude. For accurate information, write to the Agriculture Extension Service, Colorado State University, Fort Collins, Colorado 80521. Specify the type of information and the baking mode (convection bake or bake) you need, i.e. cakes, breads, etc. There may be a cost for the bulletins.

TO USE THE OVEN ON LOW TEMPERATURE

The oven can be used to keep hot food hot, to dehydrate food, to warm plates, for slow cooking (as in a crock pot), and to defrost foods.

You can keep hot, cooked food at serving temperature. Set the oven to the temperature suggested in the chart. Rare meat must be eaten when it is removed from the oven, as continues cooking from its own heat.

To keep food moist, it must be covered with aluminum foil or a lid.

To dehydrate food, follow suggestions in a recipe.

To warm plates, check with the dishware manufacturer for the recommended temperatures.

To use the oven as a low cooker set the oven control knob to 255°F. Place the food in the oven in a pan with a tight fitting lid. Follow recipes for this type of cooking.

To thaw uncooked frozen food, set the oven control knob to "warm". Be sure the food is tightly wrapped in foil. Thaw the food just enough. Cook immediately.

Do not refreeze.

To thaw frozen cooked food, set the oven knob to 170°F. Loosen the freezer wrapping. Do not use plastic wrap or wax paper in the oven.

FOOD SAFETY

According to the United States Department of Agriculture you should not hold foods at temperatures between 40°F to 140°F for longer than 2 hours. USING CONVECTION BROIL AND REGULAR BROIL.

TO SET THE OVEN FOR CONVECTION BROIL AND REGULAR BROIL

CAUTION: Pay special attention when setting the Oven Control Knob on "BROIL". If you set the knob past the "BROIL" setting, the burner will not ignite.

Decide if you are going to use REGULAR BROIL or CONVECTION BROIL. If you are going to use regular broil turn the Oven Control knob To "BROIL". To use Convection Broil turn the Oven Control Knob to "BROIL" and press the CONVECTION button to operate the fan. The burner will ignite after the gas reaches the fan. The "oven on" indicator light will come on to let you know that the broiler is currently on. During the broiling process, the infra-red burner produces such an intense heat that the burner will cycle on and off to maintain an efficient yet safe interior cooking environment.

The HEATING indicator light on the valve panel cycles on and off with burner to let the user know when the burner is lit. This cycling process is used to evenly distribute and safety control the intense heat that the broil burner produces. The cycling feature prevents the burner from producing range-damaging heat.

RACK POSITION

The rack position depends on the type and thickness of the food. Thick pieces of meat or poultry (1" or more) would typically be broiled or convection broiled on rack position 4. Steaks,

chops and hamburgers would typically be broiled on rack position 4. If top browning casseroles or bread, the thickness of the food will indicate the position. Casseroles and bread would typically be browned on rack position 2 (see instructions below for more information).

CONVECTION BROIL

Convection broil is cooking by intense infrared radiant heat supplied by the broil burner while fan at the back of the oven circulates hot air in a continuous pattern around the food. Convection broil cooks the food with better results for thicker cuts of meat. The meat sears on the outside and retains more juices and natural flavor inside with less shrinkage.

FOODS SUITABLE FOR CONVECTION BROILING:

Thicker Cuts of Meat (1" or more)
Rack position #3 (same position for broiling)

Thicker, Irregular-sized Pieces of Poultry (1" or more),
Rack position #2 or #3 (same position for broiling)

Thicker, Pieces of Fish (1" or more)
Rack position #3 (same position for broiling)

Top Browning: Casseroles and Breads
Rack position #2 or #3 (same position for broiling)

REGULAR BROIL

Broil is cooking by intense infrared radiant heat supplied by the broil burner located at the top of the oven.

FOODS SUITABLE FOR BROILING:

Appetizers
Rack position #3 or #4
Meats, Poultry, Fish (under 1")
Rack position #4

Top Browning: Casseroles and breads
Rack position #2 or #3

NOTE: The broiler pan for both broiling and convection broiling should be placed all the way to the back of the oven and centered on the rack for best results.

USING A MEAT THERMOMETER TO BROIL AND CONVECTION BROIL

To accurately determine the doneness of a thick steak or chop (1-1/2 inches thick or more), use a meat thermometer. Insert the point of the thermometer into the side of the meat to the center. Cook the first to 90°F for rare meat. Cook the first side 100°F for medium to well done. Cook the second side to the desired degree for the doneness you want, 140°F to 145°F for rare, and 150°F to 155°F for medium and 160°F to 165°F for well done. If you are cooking pork, cook to 160°F.

A large two-piece broil pan comes with your new range. When you are broiling, always use both pieces. Do not cover the grid with aluminum foil. This slotted grid allows the grease drippings to flow into the bottom of the pan keeping it away from the intense heat of the infra-red broiler burner. This help to minimize the smoking and spattering of the grease.

TO GET THE BEST RESULTS

OPEN DOOR BROILING

NOTE: Open Door Broiling is also possible with the Precision Series oven. However, the oven door hinge DOES NOT have a dedicated Broil-Stop position. To achieve the best results for Open-Door Broiling, open oven door approximately 6-8 Inches.

WARNING! NEVER leave pets and/or small children unattended while oven is in the Open Door Broiling position. Front panel and knobs may get hot to the touch as the heat is directly escaping to the front section of the oven. Wear oven mitts and always use Caution!

NOTE: It is not recommended to use the convection fan if Open Door Broiling.

- Defrost the food before starting to cook.
- Put food on broiler pan, center and push broiler pan to the very back of the oven rack.
- Set a minute timer for the minimum time to check the food.
- Steaks should be at least one inch thick, if rare doneness is desired. It is difficult to get rare with meat that is thinner.
- After half the total cooking time, turn the food over only once. It is not necessary to turn over thin foods (fillet of fish, Ham slices, etc.). Liver slices must be turned over.
- Use a two-piece broil pan. Two-piece broil pans are designed to minimize smoke and spatter. DO NOT cover the slotted grid with aluminum foil. This will catch the grease and could cause a fire.

When top browning use metal or glass-ceramic bake ware. DO NOT use heat-proof Glass or pottery as this type of glassware cannot withstand the intense heat of the broiler burner. Place the vertical positioning rod into the hole located on the bottom left side of the oven can.

- **NOTE: You cannot use the broiler burner and the bake burner at the same time. When one is on, the other cannot be turned on!**

USING THE OVEN ROTISSERIE

Your Gas Self Clean oven contains a rotisserie system, complete with a vertical positioning rod, a U-bracket, a horizontal spit rod, and heavy-duty, cast stainless steel prongs. Also, the oven comes with a porcelain-coated, two piece broiler pan, provided for your convenience.

Using the rotisserie is quite simple.

- Place the vertical positioning rod into the hole located on the bottom left side of the oven can.

- Place your rotisserie spit-rod with your meat prepared between the two prongs on the U-bracket, and swing into place on the right side wall of the oven can.
- Place the broil pan directly beneath the meat.
- Close oven door
- Set the oven to Broil mode
- Press the rotisserie button on the left side of the front panel which will activate the rotisserie motor.

NOTE: For Convection Rotisserie, simply follow the same steps and first press the rotisserie button, followed by the convection button.

NOTE: Rotisserie system is only available in the Precision Series gas Self-Clean Ranges and NOT the Precision Series standard non-self clean gas convection ranges, NOTE: Rotisserie system can ONLY be used in the Broil Mode, and not Bake mode.

INTERNAL COOKING TEMPERATURES:

FOOD	OVEN TEMPERATURE
Egg and Egg Dishes	
Eggs	Cook until yolk and white are firm
Egg Casseroles	160 degree F
Egg Sauces, Custards	160 degree F
Ground Meat and Meat Mixtures	
Turkey, Chicken	165 degree F
Beef, Veal, Lamb, Pork	160 degree F
Fresh Beef, Veal, Lamb	
Medium Rare	145 degree F
Medium	160 degree F
Well Done	170 Degree F
Fresh Pork	
Medium	160 degree F
Well Done	170 degree F
Roast Beef	
Cooked Commercially	140 degree F
Vacuum Sealed	140 degree F

Ready to eat 140 degree F

Poultry

Chicken, Turkey-Whole 180 degree F

Chicken, Turkey-dark meat 180 degree F

Poultry-breast 170 degree F

Duck and Goose 180 degree F

Stuffing

Cooked alone or in bird 165 degree F

Sauces, Soups, Gravies, Marinades

Used with raw meat, poultry, or fish Bring to boil

Seafood

Fin Fish Cook until opaque and flakes easily with a fork

OVEN SELF-CLEANING

The self-cleaning oven of your new range features pyrolytic self-cleaning. When set in the SELF-CLEAN mode, the oven reaches a high temperature that burns off the food soil.

When the oven is on for SELF-CLEAN, only the RANGETOP burners can be used.

NOTE: Before turning oven to self-clean mode, wipe up the excessive Food Soil. This will minimize any excessive smoke or flames that may occur.

It is common to see smoke and/or flames during the SELF-CLEAN cycle, depending on the content and amount of soil remaining in the oven. If a flame persists, turn off the oven and allow it to cool before opening the door to wipe up the excessive food soil.

At the end of the SELF-CLEAN cycle, some gray ash or burned residue may remain inside the oven. This is a mineral deposit that does not burn or melt. The amount of ash depends on how heavily soiled the oven was before the oven was cleaned. It is easily removed, once the oven has cooled, using a damp paper towel, sponge, or cloth.

Wipe off any smoke residue that remains on the

front frame with Formula 409® or Fantastik®. If stain remains, use a mild liquid cleanser. The amount of smoke stain is directly related to the amount of food soil left in the time of self-cleaning. Clean the oven often.

OVEN DOOR LOCK DURING SELF-CLEAN

When the clean cycle starts, the lock light turns on, and the automatic door lock cycle begins. Do not attempt to open the door when the lock light is on. You can stop the cycle by turning to OFF position. The lock light will turn off only after the oven has cooled below 550°F, and the automatic door lock has completed its cycle to the open position.

BEFORE SELF-CLEANING THE OVEN: Remove all utensils and racks.

- Clean the oven front frame and outer door edges. Wipe up large spill ovens and grease.
- Be sure the light bulbs and glass covers are in place.
- Turn on the ventilation hood above the range and leave it on until after the oven has completed the self-clean cycle.
- Wipe out puddles of grease and any loose soil that can be easily removed.
- Remove any soil that is outside the door seal area. This appliance is designed to clean the oven interior and that portion of the door that is inside the oven. The outer edges of the door are not in the cleaning zone.

WIPE THIS AREA CLEAN BEFORE SETTING THE OVEN TO SELF-CLEAN.

SETTING THE OVEN FOR SELF-CLEAN

1. Set Oven Control Knob to "CLEAN".

Blower turns on.

SELF-CLEAN Light turns on.

DOOR LOCK Light turns on immediately and the door latch engages within 10 seconds of setting Oven Knob to Self-Clean Mode.

The door closing process takes approximately 60 seconds to complete, at which time the door becomes locked.

AT THE END OF THE CLEAN CYCLE

The Clean cycle takes 5 hours to complete. The DOOR-LOCK light turns off once the cycle has finished.

1. The door latch will open automatically after the oven temperature falls below 550°F and the automatic Door Lock completes its 60 sec. cycle to the OPEN position.

CAUTION: The interior of the oven will still be at baking temperature when the lock light turns off and the oven door can be opened. Use caution as the oven may be hot enough to cause burns.

2. Turn the Oven Control Knob to OFF. Wipe off white ash residue with a damp cloth or sponge before placing oven racks.
3. Replace the oven racks.

All stainless steel parts of the appliance can be cleaned with hot soapy water, rinsed, dried and buffed to a shine with a soft, heavy pile cloth. Make sure you clean in the DIRECTION OF THE GRAIN and never in circular motions as this may scratch

When cleaning this range or range-top:

1. Always use the mildest cleaning procedure first. Some brands of cleaners of the same type are harsher than others, read their directions. A scent or a propellant can make a difference in the product. Read the ingredients. Try on a small area first.
2. To avoid marring the surface always rub metal finishes in the direction of the polish (grain) lines. The cleaner will be more effective when used in the direction of the polish lines.
3. Use only clean sponges, soft cloths, paper towels, for cleaning or scouring (Use only soap pads with soap still in them. An empty pad can scratch), as recommended in this section.
4. Be sure to rinse all parts thoroughly and to wipe dry to avoid water marks.

NOTE: BRAND NAMES - In this section on cleaning, the use of name brands is intended only to indicate a type of cleaner. This is not constitute an endorsement. The omission of any name brand cleaner does not imply its adequacy or inadequacy. Many products are

RANGETOP

Turn off all the burners and allow the grates to cool before starting to clean the range top. Do not clean hot surfaces.

This could burn you. Clean only when the range or Range top has cooled to room temperature.

BURNER GRATES

When lifting the grates, be careful as they are heavy. Place them on a protected surface, so they won't scratch the surface they are laid on.

The burner grates are matte porcelain enamel over cast iron. When cool they may be placed in the dishwasher, or wipe while on the range top using hot soapy water, then rinsed and wiped dry. The burner grates will not rust as they are matte porcelain enamel on both sides for durability.

The occasional use of mild abrasive cleaners such as Bon-Ami®, Soft Scrub®. Abrasive cleansers, used vigorously or too often, can eventually harm the enamel. Apply with a damp sponge, rinse thoroughly and dry.

The porcelain may pop off the edge of the grates due to rapid temperature change when the burners are turned on. Do not be concerned as this does not result in the deterioration of the grates. The cast iron soon darkens to blend with the porcelain enamel. Be careful when wiping an area where the porcelain has popped off, as the edges may be sharp.

BURNERS

For proper lighting and performance keep the

burners clean. It is necessary to clean the burners if they do not light even through the igniter clicks, if there has been a severe boil over, or when the flame

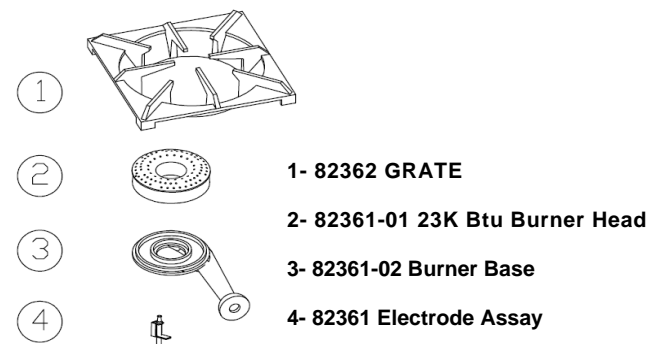

the grates and burners are cool, remove the grate. The Burner Cap can easily be removed. Wash these parts in hot soapy water, rinse and dry thoroughly. The Burner Caps are porcelain enamel, follow the directions on the previous page that were given for the burner grates. A bristle brush can be used to clean out the toothed burner ports, if necessary.

After cleaning, it is important to make sure the Locating Notch at the bottom of the Burner Cap is properly aligned with the Burner Base.

Incorrect alignment will produce a potentially dangerous flame and poor burner performance

IGNITERS

Wipe with a water-dampened cotton swab. Be careful not to damage the igniter. (See illustration).

CONTROL KNOBS - RANGETOP AND OVEN

These are made of die-cast metal with plastic inserts for easier gripping. They can be cleaned in hot, soapy water. To remove the Knobs from the control panel, grasp the knob and pull straight forward. Wash, do not soak. Rinse and dry thoroughly. It is important to replace these knobs on the correct gas valve on the control panel.

LOW BACK, OR HIGH SHELF (IF INSTALLED)

Depending on the model, these are constructed of all stainless steel. Use the mildest cleaning procedure first— hot soapy water, rinse and dry. If the panel has food soil remaining, try a general kitchen cleaner, such as Fantastic, Simple Green®, or Formula 409. For hard to clean soil use a stainless steel cleaner such as, Bon-Ami®, Cameo®, or Bar Keepers Friend. Apply cleaner with a damp sponge, rinse thoroughly and dry. Always scrub lightly in the direction of the grain. Do not use a steel wool pad, it will scratch the surface. To touch up noticeable scratches in the stainless steel, sand very lightly with dry 100 grit emery paper, rubbing in the direction of the grain. After cleaning use a stainless steel polish, such as Stainless Steel Magic.

If the rear top burners are used extensively on high it is possible for the vertical stainless steel panel to discolor from the burner heat. This discoloration can be removed by using Revere Ware Stainless Steel Cleaner.

OVEN AND DOOR INTERIOR

If in the event the oven door comes off track, or becomes misaligned, realignment can be achieved by following this simple procedure:

Open the door and hold it all the way open. Close the hinge latches. Once both hinges are locked, gently lift the door up and partially out until the door is evenly aligned. Evenly slide the door back into place and check to assure the hinges rest in

the center of each door hinge roller. With the oven door fully open, unlock hinge latches and the door is ready to close again. Call our service technician if you encounter difficulty.

Be sure the oven and door are cool before you start to clean them. They are porcelain enamel coated. It is acid resistant, but not acid proof. Therefore, acid foods, such as vinegar, rhubarb, alcohol, citric juices or milk, should be wiped off and not allowed to bake on.

Try **mild cleaners**, such as: Bon-Ami®, Ammonia, Ammonia and water, or Soft Scrub®. Apply the cleaner on a damp sponge or cloth. Rub lightly. Rinse thoroughly and dry. If food has burned onto the oven and is difficult to remove, soak the spots with a cloth saturated with household ammonia. Allow it to soak for an hour or two, with the door closed. The food soil should be easy to remove with a damp soapy cloth or mild abrasive.

OVEN RACKS AND ROLLERS

The oven racks and rollers are chrome plated steel.

Chrome cleaners, such as Soft Scrub, Cameo or Bar Keepers Friend can be applied with a damp sponge following package directions. Rinse and dry. Powdered cleaners such as Bon-Ami® or Comet are applied with a damp sponge or cloth, rubbed lightly, rinsed and dried. Harsh Cleaners which are commercial oven cleaners, such as Easy Off® or Dow can be used on the racks. However, some commercial oven cleaner's cause darkening and discoloration. Test the cleaner on a small part of the rack and check for any discoloration before cleaning the entire rack. Allow to stand for 15 to 20 minutes. Rinse thoroughly and dry.

FRAMES, SIDES, DOOR EXTERIOR, HEAT DEFLECTOR

These parts are made of stainless steel, follow the directions for the Backguard (see page 28). Take care when cleaning the door top. Do not let water or cleaners run down the vents. If water or cleaners spill into the vents, they may streak the glass inside the door.

DOOR GASKET

Use a general kitchen spray cleaner, such as Formula 409 or Fantastik®. Spray it and blot dry with a cloth. Do not rub. Do not remove or damage the gasket

OVEN LIGHT BULB REPLACEMENT

For oven light bulb replacement use only a 40 watt, 120 volt appliance light bulb. These are available in supermarkets. DO NOT use a standard light bulb in any oven, the heat will break it.

TO REPLACE THE LIGHT BULB:

1. Be sure the oven light bulb switch is in the off position.
2. Let the cover and the bulb cool completely.
3. Remove the light cover, Turn the cover to the left (counterclockwise) to unscrew it.
4. Remove the burnt out bulb. Replace it with a 40 watt appliance light bulb only.
5. Replace cover. Turn circuit breaker back on, if turned off. (See Caution below).

CAUTION: Be sure the oven light switch (see page 8, # 11) is in the OFF position and the light cover is cool. If the bulb comes loose from its base, turn off the power to the oven at the circuit breaker panel, before attempting to remove the bulb base from the socket.

POWER FAILURE

The broiler and oven burners cannot be turned on during a power failure. To light the sealed top burners, turn the control knob to "lite" hold a lighted match to the port ring. After the flame is burning all the way around the burner, adjust the flame to the desired height. It is necessary to light each burner individually. Do not light more than one burner at a time.

LOCATING RATING PLATE

SERIAL #, MODEL # AND VERIFYING GAS TYPE

The rating plate contains necessary information regarding your range. It provides the model #, serial # and verifies the gas type and BTU input ratings for each burner of your appliance. When calling for service, please have this information at hand.

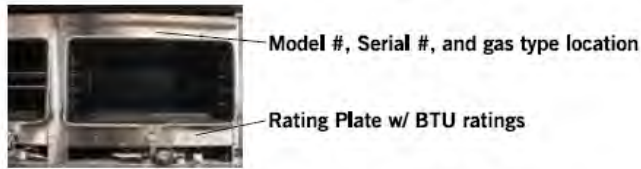

The model #, serial # and gas type information is located in two places. First, when you open the oven door, you will find a sticker that shows the model # followed by either an N (for natural gas) or L (for LP gas), and the serial # (see picture).

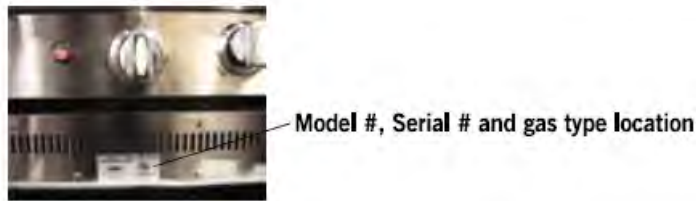

The rating plate, showing the model #, serial #, gas type and gas BTU input ratings for each burner, as well as necessary information from ETL test labs, is located behind the kick-plate. You will need to remove the kick-plate to access this information (see picture).



RANGES AND RANGE-*TOP

PROBLEM	POSSIBLE CAUSE	PROPOSED SOLUTION
Range non-functional	No electricity or gas supply	Turn on gas supply valve
		Check circuit breakers
	Technical	Call for authorized service
One or more burners will not light	No electricity	Check circuit breakers
	No gas	Check gas supply at wall
	Wrong gas type	Verify gas type
	Burners are dirty	Clean burners ports
	Burners are mis-aligned	Align and reassemble burners
	Water in burner(s)	Dis-assemble and dry burners
	Dirty electrode(s)	Clean burner electrode
	Technical	Call for authorized service
Incorrect flame/ sooty burner flame	Too large or small flame	Verify gas type
	Mis-aligned burner assembly	Realign and re-assemble burner assembly
BBQ-GRILL doesn't light	No Electricity	Check circuit breaker
	No gas	Check gas supply at wall
	Burner is dirty	Clean burner

RANGE OVENS

PROBLEM	POSSIBLE CAUSE	PROPOSED SOLUTION
No oven light	No electricity	Check circuit breakers Check plug at wall
	Loose bulb	Ensure bulb is properly screwed in
	Burned out bulb	Replace bulb
No oven heat (bake)	No gas	Check for proper top burner operation
	No electricity (check oven light)	Check circuit breakers Check plug
	Improper settings	Verify proper settings on knob selector
No oven broil	Improper settings (see no bake)	Verify proper settings
Uneven baking	Insufficient pre-heat time	Allow oven to preheat at least 15 minutes before baking
	Improper settings	Verify proper settings on knob selector
	Improper utensils/placement	Use proper utensils and place them properly in the proper rack positions
No convection	No convection fan	Check for air movement
Convection noisy	Technical	Call for authorized service
Rotisserie not working	Vertical Rotisserie rod not firmly in place	Place rod firmly in rotisserie location hole
Rotisserie noisy	Technical	Call for authorized service

CULINARIAN SERIES RANGES**CULINARIAN SELF CLEAN CONVECTION MODELS****CGSR (30" 36" 48" 60")****CULINARIAN MANUAL CLEAN CONVECTION MODELS****CGMR (30" 36" 48")**

TABLE OF CONTENTS

Important Information	29
30" - All Models	30
36" - All Models	31
48" - All Models	32
60" - All Models	33
Unpacking and Ventilation Requirements	34
Cabinet Install Drawing / Front View	35
Cabinet Install Drawing / Side View	36
Installation Instructions	37-38
Gas Hook-Up / Testing and Adjustments	39
Post-Install Check	40
Service & Warranty Info	41

PLEASE READ ENTIRE INSTRUCTIONS BEFORE PROCEEDING.

WARNING! If the information in this manual is not followed exactly, a fire or explosion may result causing property damage, personal injury or death.

WHAT TO DO IF YOU SMELL GAS

- Do not try to light any appliance
- Do not touch any electrical switch
- Do not use any phone in your building
- Immediately call your gas supplier from a neighbor's phone. Follow the gas supplier's instructions.
- If you can not reach your gas supplier, call the fire department.

IMPORTANT: Save these instructions for the Local Gas Inspector's use.

INSTALLER: Please leave these Installation Instructions with the unit for the owner.

OWNER: Please retain these instructions for future reference.

The appliance, when installed, must be electrically grounded in accordance with local codes or, in the absence of local codes, with the National Electrical Code, ANSI/NFPA 70

The appliance and its individual shutoff valve must be disconnected from the gas supply piping system during any pressure testing of that system at test pressures in excess of 5 psi (35 kPa).

The appliance must be isolated from the gas supply piping system by closing its individual manual shutoff valve during any pressure testing of the gas supply piping system at test pressures equal to or less than 5 psi (35 kPa).

WARNING! Disconnect Power before installing. Before turning power ON, be sure that all controls are in the OFF position.

IMPORTANT! Installation must conform with local codes.

IMPORTANT INSTALLATION INSTRUCTIONS INTRODUCTION

Capital's CULINARIAN Series Gas Ranges are tested and approved in accordance with ANSI Z21.1.2005, CAN 1-1.1,M81 1995, Household Cooking Appliances. It is **STRONGLY RECOMMENDED** that this appliance be installed in conjunction with a suitable overhead CAPITAL VENT HOOD Due to the high heat output of this unit, particular attention should be paid to the hood and ductwork installation to assure it meets local building codes.

NOTE: Local building codes vary. Cabinet storage above the unit should be avoided to prevent the risk of accidental fire or burns.

In the commonwealth of Massachusetts, gas connection must be performed by a licensed plumber or gas fitter.

IMPORTANT! Installation, electrical connections, grounding and gas connections must comply with all applicable codes. In the absence of local codes, the unit should be installed in accordance with the National Fuel Gas Code ANSI Z223.1/NFPA54-CURRENT ISSUE and National Electrical Code ANSI/NFPA70-CURRENT ISSUE.

Be sure the unit being installed is set up for the type of gas supplied. The Gas range shipped from the factory is set for Natural Gas or LP (Propane), depending on the specific model ordered.

ENSURE THAT THE RANGE IS COMPATIBLE WITH GAS SUPPLY AT THE INSTALLATION SITE BEFORE PROCEEDING FURTHER. Contact the dealer if it is not set for the proper gas supply available at the installation site.

IMPORTANT! A back guard must be utilized when there is **less** than 12" horizontal clearance between combustible materials and the back edge of the range. The Capital CULINARIAN SERIES Low Back or High Shelf must be ordered separately and installed at the rear of the range. For island installations and other installations with more than 12" clearance, our stainless steel Island Trim is suitable to cover the back guard mounting flanges.

GAS SUPPLY

NATURAL GAS: 6-inch water column. (14.9mb) Min., 8 inch (20mb) nominal

PROPANE GAS: 11-inch water column. (27.4m b), 14 inch (37mb) maximum

ELECTRIC POWER SUPPLY

CGSR30, CGMR30 models - 120 VAC, 60 HZ, 1 PH., 20 Amp Circuit

CGSR36, CGMR36 models -120 VAC, 60 HZ, 1 PH., 20 Amp Circuit

CGSR48, CGMR48 models -120 VAC, 60 HZ, 1 PH., 20 Amp Circuit

CGSR60, CGMR60 Models -120 VAC, 60 HZ, 1 PH., 20 Amp Circuit.

STEP 1: UNPACKING, MOVING and PLACING the RANGE

CAUTION: Proper equipment and adequate manpower must be used in moving the range to avoid damage to the unit or the floor. The unit is heavy and rests on stainless steel legs.

- It is strongly recommended that after removing the packing material, remove the door(s), top grates, oven racks, front kick plate and drip pan(s) to facilitate lifting and easier handling.
- Remove the outer carton and packing materials from the shipping base. The all gas ranges are held to the skid by three (3) bolts. After removing the bolts the range must be lifted and removed from the skid. **Never lift the range from the oven door handle.**

SELF CLEAN

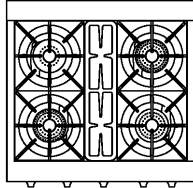

CGSR304

four open top burners

MANUAL CLEAN

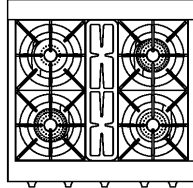

CGMR304

four open top burners

ALL BURNERS RATED AT 23,000 BTU / HR

SELF-CLEAN

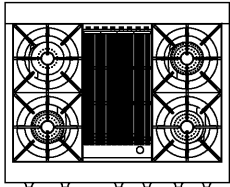

CGSR362B2

Four Burners + BBQ Grill

MANUAL-CLEAN

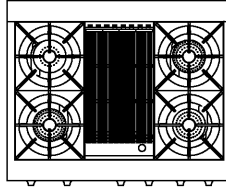

CGMR362B2

Four Burners + BBQ Grill

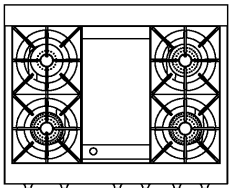

CGSR362G2

Four Burners + Griddle

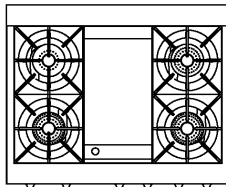

CGMR362G2

Four Burners + Griddle

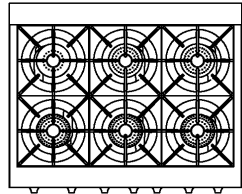

CGSR366

Six Burners

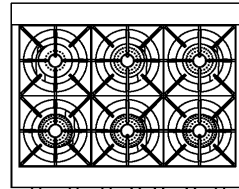

CGMR366

Six Burners

ALL BURNERS RATED AT 23,000 BTU / HR

SELF CLEAN

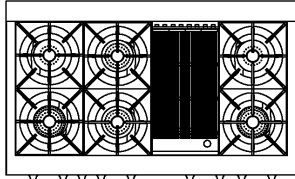

CGSR484B2

Six open top burners
+ 12" BBQ Grill

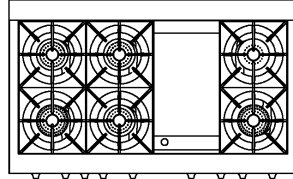

CGSR484G2

Six open top burners
+ 12" griddle

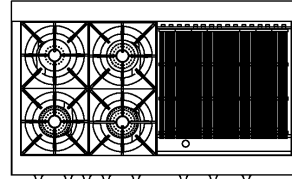

CGSR484BB

Four open top burners
+ 24" BBQ Grill

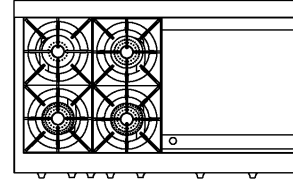

CGSR484GG

Four open top burners
+ 24" Griddle

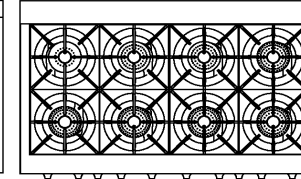

CGSR488

Eight open top burners

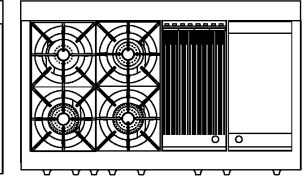

CGSR484GB

Four open top burners
+ 12" Griddle + 12" BBQ Grill

MANUAL CLEAN

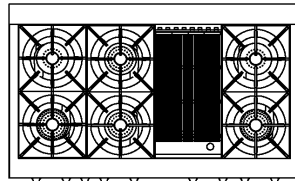

CGMR484B2

Six open top burners
+ 12" BBQ Grill

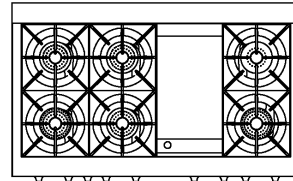

CGMR484G2

Six open top burners
+ 12" griddle

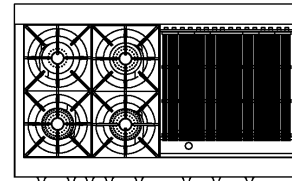

CGMR484BB

Four open top burners
+ 24" BBQ Grill

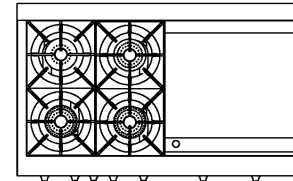

CGMR484GG

Four open top burners
+ 24" Griddle

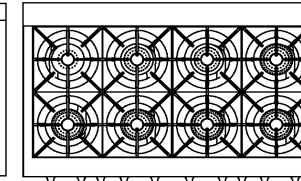

CGMR488

Eight open top burners

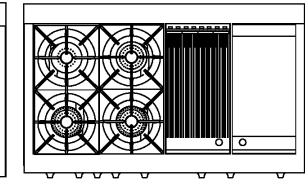

CGMR484GB

Four open top burners
+ 12" Griddle + 12" BBQ Grill

ALL BURNERS RATED AT 23,000 BTU / HR

SELF CLEAN

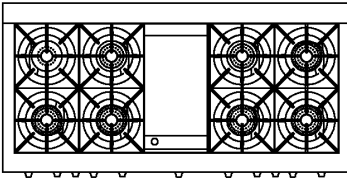

CGSR604G4
Eight open top burners
+ 12" Griddle

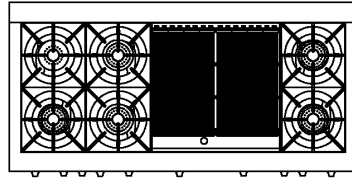

CGSR604BB2
Six open top burners
+ 24" BBQ

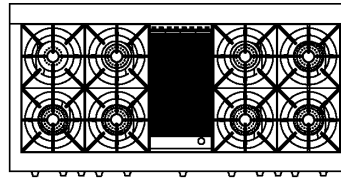

CGSR604G4
Eight open top burners
+ 12" BBQ Grill

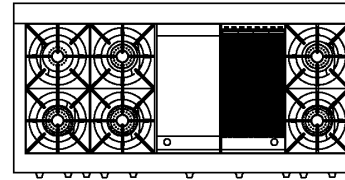

CGSR604GB2
Six open top burners
+ 12" Griddle + 12" BBQ Grill

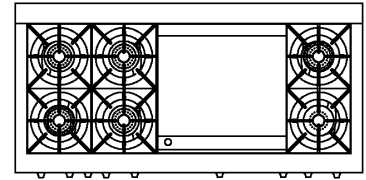

CGSR604GG2
Six open top burners
+ 24" Griddle

ALL BURNERS RATED AT 23,000 BTU / HR

- Lift the range from the skid with a soft wheel dolly.
- Support the range uniformly across the bottom
- To remove door, open the door completely, close the hinge latches and release the door. Remove door by lifting and pulling from the sides.
- Make sure gas and electric connections are made, anti-tip device is installed, and the back guard installed prior to placing the range in position.
- Measure the height of the counter top and adjust the range height to match countertop height by adjusting front and rear leveling feet.
- Slide the range in place and ensure that the range is level.
- Reinstall the kick plate, top grates, oven door(s), drip pan tray(s), and make sure burner caps are seated firmly located into position.

WARNING: DO NOT lift the range by the oven door handles, Do not remove the griddle and grill sections!

STEP 2: VENTILATION REQUIREMENTS

It is strongly recommended that a suitable CAPITAL exhaust hood be installed above the range. Downdraft ventilation should NOT be used. The table below indicates the PRECISION Series Hoods, by model number, that are recommended for use with all ranges.

1. SELECT HOOD AND BLOWER MODELS:

SIZE	SHIPPING WEIGHT
30"	400
36"	450
48"	630
60"	800

For wall installations, the hood width must, at a minimum, equal the width of the range's cooking

surface. Where space permits, a hood larger in width than the cooking surface may be desirable for improved ventilation performance.

VENTILATION UNIT	STANDARD COUNTER INSTALLATION RECOMMENDATIONS
HOOD	(24" DEEP X UNIT WIDTH)
BLOWER CFM's	
60" RANGE = 1200 CFM	
48" RANGE = 1200 CFM	
36" RANGE = 1200 CFM	
30" RANGE = 600 CFM	

CAUTION: Ventilation hoods and blowers are designed for use with single wall ducting. However, some local building codes or inspectors may require double wall ducting. Consult local building codes and/or local agencies, before starting, to assure that hood and duct installation will meet local requirements.

CAPITAL Hood blower speeds are variable to reduce noise and loss of heated or air-conditioned household air when maximum ventilation is not required. Normally the maximum blower speed is only required when using the grill section.

2. HOOD PLACEMENT:

For best smoke elimination, the lower edge of the hood should be installed a minimum of 30" to a maximum of 36" above the range cooking surface.

STEP 3: CABINET PREPARATION

1. The range is a freestanding unit. If the unit is to be placed adjacent to cabinets, the clearances

shown in fig. 1 are required. The same clearances apply to island installations, except for the overhead cabinets, which must have a space wide enough to accept a suitable flared island hood, as indicated in fig. 1. **Note: Capital does NOT offer an island style ventilation hood at this times.**

2. The maximum depth of overhead cabinets installed on either side of the hood is 13".
3. A 30-inch minimum clearance is required between the top of the range and the bottom of an unprotected cabinet.
4. Any openings in the wall behind the range and in the floor under the range must be sealed.
5. When there is less than 12" horizontal clearance between combustible material D and the back edge of the range above the cooking surface, a Capital Low Back or High Shelf back guard must be installed (see Fig. 2A). When clearance to combustible material D is over 12", a Capital Island Trim may be used (See Fig. 2B). Figures 2A and 2B indicate the space required for each type of back guard.
6. Always keep appliance area clear and free from combustible materials, gasoline, and other flammable vapors and liquids.
7. Models with open broiler, noncombustible material is to be installed on the underside of a cabinet located above the broiler section or unit in accordance with local codes, or in the absence of local codes, with the National Fuel Gas code, ANSI Z223.1/NFPA.54

WARNING: DO NOT obstruct the flow of combustion and ventilation air to the unit.

PLEASE NOTE:

In the Commonwealth of Massachusetts, gas connection must be performed by a licensed plumber or licensed gas fitter.

FIG 1A. Cabinet Clearances:

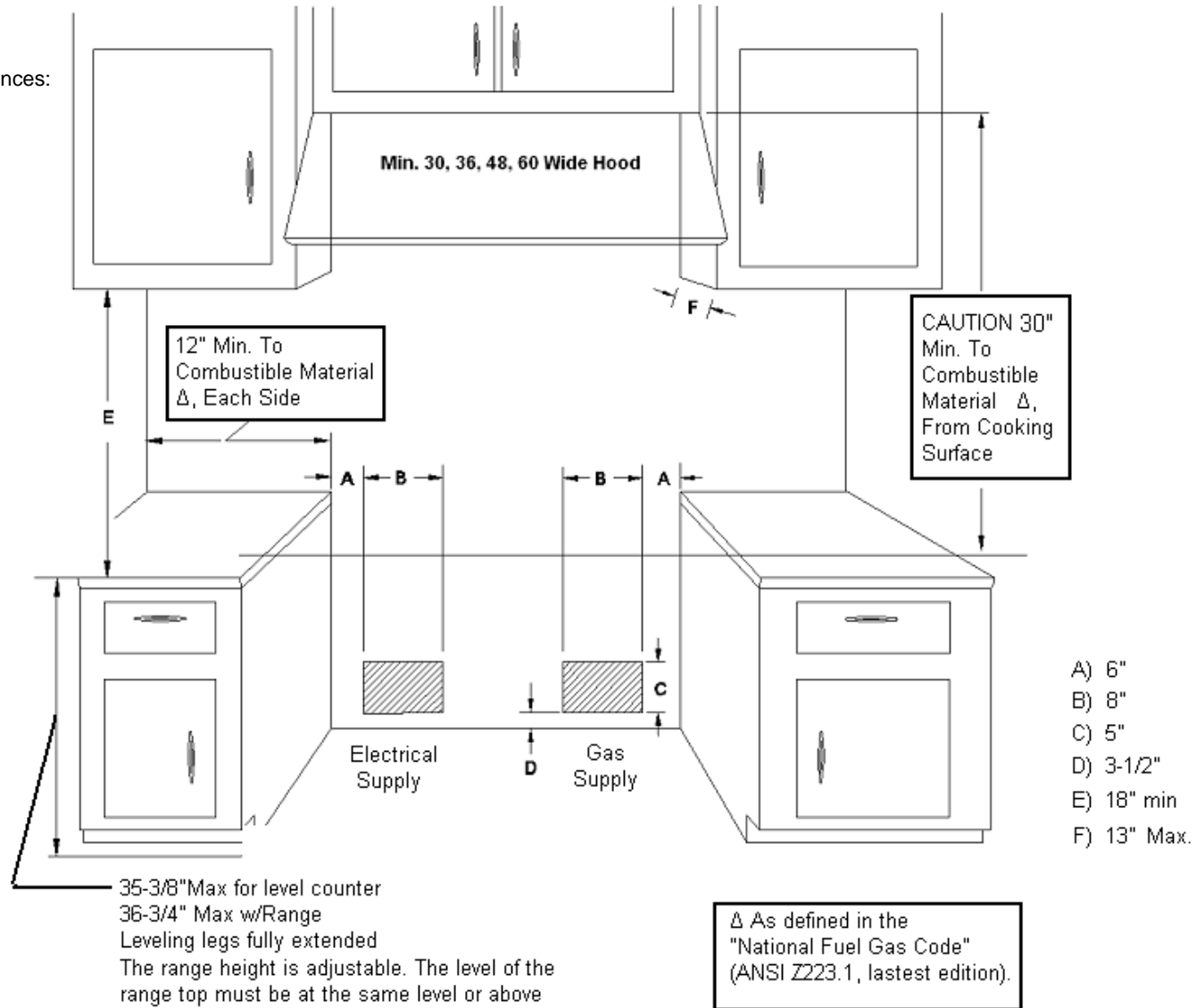

	Range Widths	Cut Out Widths
30 RANGE	29-7/8	30 1/8
36 RANGE	35-7/8	36 1/8
48 RANGE	47-7/8	48 1/8
60 RANGE	59-7/8	60-1/8

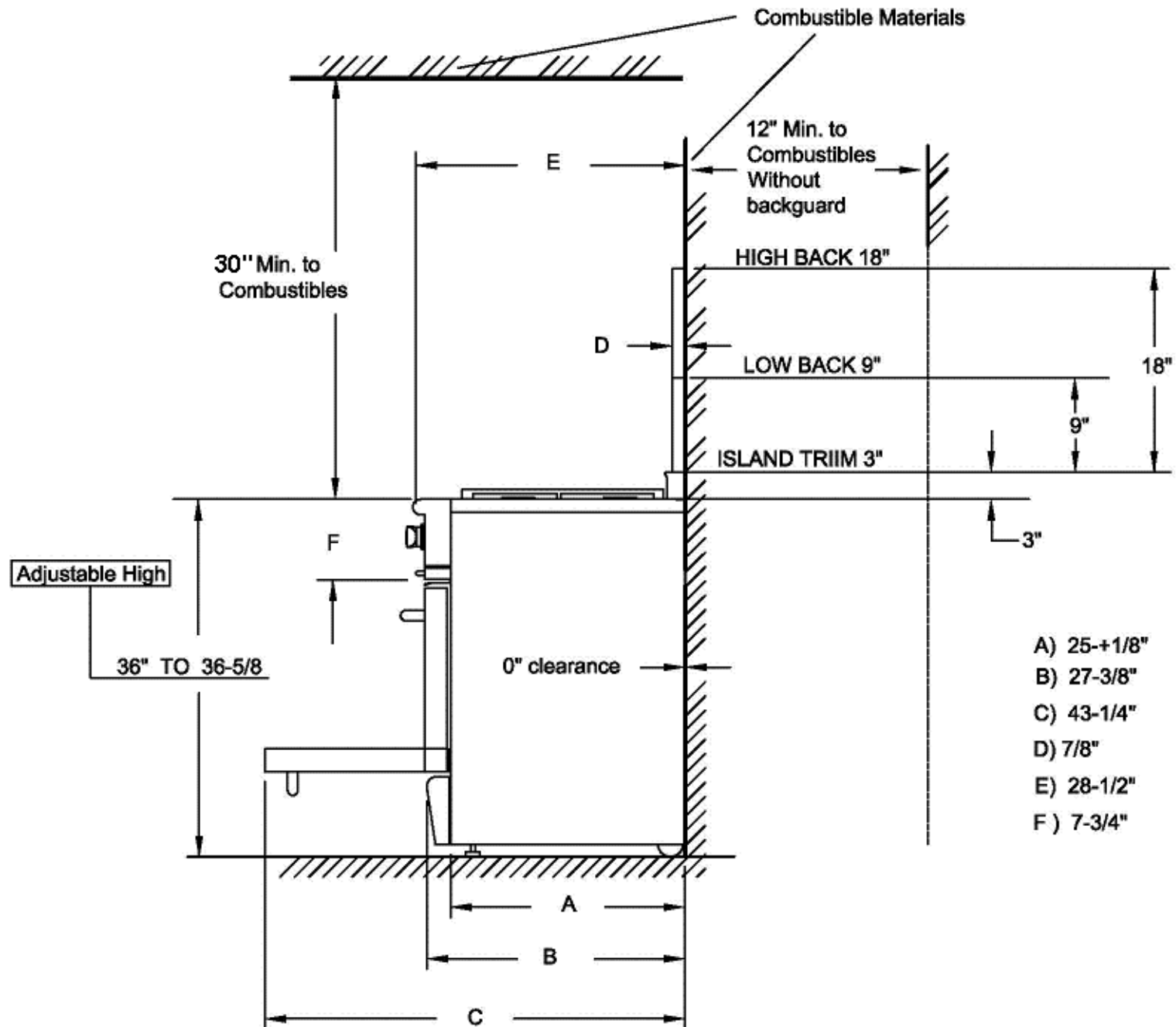

- A) 25-1/8"
- B) 27-3/8"
- C) 43-1/4"
- D) 7/8"
- E) 28-1/2"
- F) 7-3/4"

WALL MOUNT BACKGUARD INSTALLATION

NOTE: ALL CULINARIAN SERIES RANGES come with an island trim.

Secure the back guard (18" High Shelf, or 9" Low Back) directly on the wall behind range and above the factory installed island trim. **DO NOT REMOVE** the island trim. It is necessary for proper venting of the oven gases/heat.

BACKGUARD MOUNTING: WALL MOUNT HIGH SHELF

First measure from top of island trim to 16 3/8" to what will be the center of the mounting brackets. (see Fig 1)

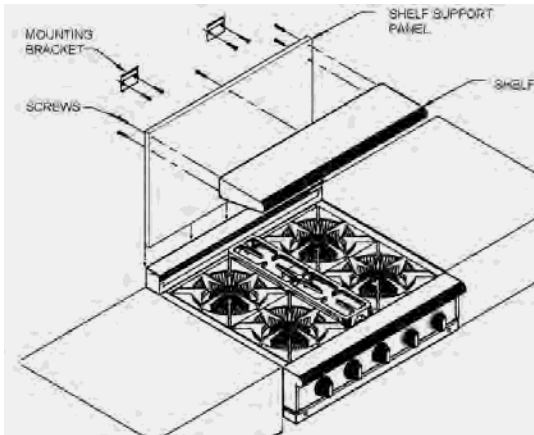

2. Secure both brackets to the wall using the screws included
3. Attach the shelf to the shelf support panels with supplied screws.
4. Slide shelf into position and over brackets.

BACKGUARD MOUNTING: WALL MOUNT LOW BACK

1. First measure from top of island trim to 16 3/8" to what will be the center of the mounting brackets. (see Fig 1)

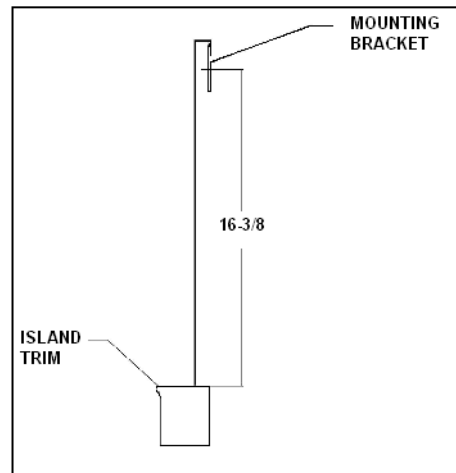

ELECTRICAL SUPPLY, ALL RANGES

Installation of All Culinarian ranges must be planned so that the rough-in of the junction box for the receptacle or conduit connection allows for maximum clearance to the rear of the unit.

This is especially critical if the junction box in the wall is directly behind the junction box of the unit when the unit is installed. To minimize binding when the unit is connected to the receptacle or junction box, orient the receptacle or conduit connector, and slide back into position.

POWER REQUIREMENTS: 120VAC, 60 HZ single phase

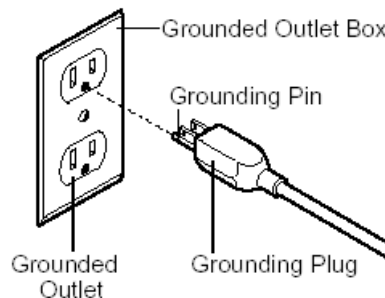

WALL CONNECTION

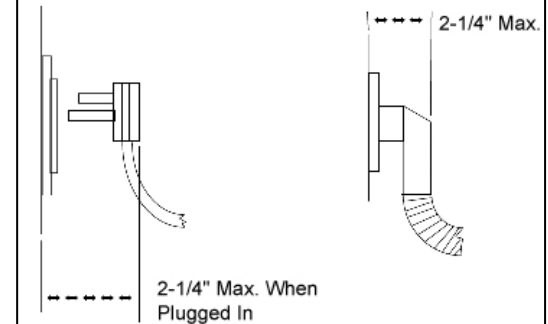

JUNCTION BOX AND CONDUIT

- 30" Range – 7 Amps. Max.
- 36" Range – 7 Amps. Max.
- 48" Range – 13 Amps. Max.
- 60" Range – 13 Amps. Max

CAUTION! Disconnect the electrical supply cord from the wall outlet before servicing the range. Follow all governing codes and ordinances when grounding. In the absence of codes follow the National Electrical **Codes ANSI / NFPA No. 70 (current issue).**

GROUNDING METHOD

The range is factory fitted with a power supply and cord with a three-prong grounding plug. It must be plugged into a matching grounding type receptacle connected to a correctly polarized 120 Volt circuit. If the circuit does not have a grounding type receptacle, it is the responsibility of the installer to have the existing receptacle changed to a properly grounded and polarized receptacle in accordance with all applicable local codes and ordinances. The receptacle replacement shall be in accordance with the national Electrical Code.

WARNING! The third prong SHOULD NOT, under any circumstances, be cut or removed!

STEP 4: INSTALLING ANTI-TIP DEVICE

For all Ranges, an anti-tip device **MUST** be installed as per these instructions.



WARNING!

- ALL RANGES CAN TIP
- INJURY TO PERSONS COULD RESULT
- INSTALL ANTI-TIP DEVICES PACKED WITH RANGE
- SEE INSTALLATION INSTRUCTION

WARNING: RANGE TIPPING HAZARD!

- All ranges can tip and injury can result. To prevent accidental tipping of the range, attach it to the floor, wall or cabinet by installing the Anti-Tip Device supplied.
- A risk of tip-over may exist if the appliance is not installed in accordance with these instructions.
- If the range is pulled away from the wall for cleaning, service or any other reason, ensure that the Anti-Tip Device is properly re-engaged when the range is pushed back against the wall. In the event of abnormal usage (such as a person standing, sitting, or leaning on an open door); failure to take this precaution can result in tipping of the range. Personal injury might result from spilled hot liquids or from the range itself.

WARNING: ELECTRICAL SHOCK HAZARD!

- Use extreme caution when drilling holes into the wall or floor. There may be concealed electrical wires located behind the wall or under the floor.
- Identify the electrical circuits that could be affected by the installation of the Anti-Tip Device, then turn off power to these circuits.

- Failure to follow these instructions may result in electrical shock or other personal injury.

CAUTION: PROPERTY DAMAGE!

- Contact a qualified installer or contractor to determine the proper method for drilling holes through the wall or floor material (such as ceramic tile, hardwood, marble, etc.)
- DO NOT slide range across unprotected floor.
- Failure to follow these instructions may result in damage to wall or floor coverings.

TOOLS NEEDED FOR INSTALLATION OF ANTI-TIP DEVICE!

1. Screwdriver, Phillips
2. Drill, electric or hand
3. Measuring tape or ruler
4. 1/8" drill bit (wood or metal wall or floor)
5. 3/16" anchors, drywall, or concrete, 2 each (not required if mounting bracket is being attached to solid wood or metal.
6. Hammer

IMPORTANT INSTALLATION INFOR-

- The Anti-Tip Bracket may be attached to a solid wood cabinet having a minimum wall thickness of 3/4".

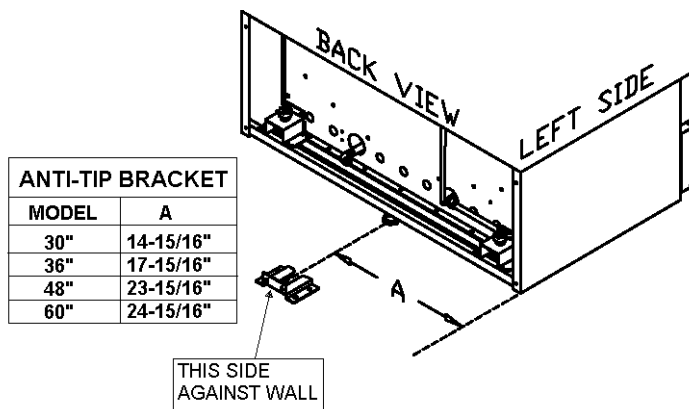

- The thickness of the wall or floor may require use of longer screws, available at your local hardware store.
- In all cases at least one (1) of the bracket mounting screws must be fastened to solid wood or metal on each side.
- Use appropriate anchors when fastening the mounting bracket to any material other than hardwood or metal.

MOUNTING ANTI-TIP BRACKET:

The alternative floor mounted bracket shall be installed as follows:

- Place bracket on floor in position shown in Figure below.
- Secure to floor or wall stud.
- Later, when unit is installed, the adjustable leg will slide under the bracket

STEP 5: GAS CONNECTION AND HOOK-UP

Verify the type of gas being used at the installation site matches the gas type of the range. As shipped from the factory, units are configured for use with Natural Gas or Propane (LP). Make certain the range matches the type of gas available at the location.

For installation of the appliance at high altitude, please consult your local gas company for their recommendation of the correct orifice sizes and any other necessary adjustments that will provide proper gas combustion at specified altitudes.

NOTE: Capital **DOES NOT** supply ranges to match varying altitudes. Orifices to adjust for combustion for differing altitudes may be purchased through Capital Cooking Equipment by calling our Parts Department at 1-866-4024600, or email us at customerservice@capital-cooking.com.

CAUTION! When connecting unit to Propane (LP) gas. Make certain the propane tank is equipped with its own high-pressure regulator in addition to the pressure regulator supplied with the appliance the pressure & the gas supplied to the appliance regulator must not, exceed 14" (37 mb) water column. A pressure test point is provided near the regulator behind the kick plate

NATURAL GAS REQUIREMENTS:

- Inlet Connection: 1/2" N.P.T.
- Min. 5/8" Dia. Flex Line.
- Supply Pressure: 6" to 14" W.C.

PROPANE (LP) GAS REQUIREMENTS:

- Inlet Connection: 1/2" N.P.T.
- Min. 5/8" Dia, Flex Line.
- Supply Pressure: 11" to 14" W.C.
- A Regulator is required at the LP source to provide a maximum of 14" W.C. pressure to the range regulator.

WARNING! Gas line cannot be run inside back cover of range. Run gas line in channel in back of range.

HOOK UP

- A manual shut off valve must be installed external to the range in an accessible location from the front for shutting off the gas supply when required.
- The supply line MUST NOT protrude beyond the back of the range.
- Ensure that the gas supply is turned OFF at the external shut-off valve before connecting the range.
- The gas supply connection must be made by an experienced technician and in accordance with local codes or ordinances. In the absence of local codes or ordinances, please refer to National Fuel Gas Code ANSI Z223.1 / NFPA54-Current Issue.
- The range is supplied with its own pressure regulator

that has been permanently mounted to the range body.

- Use 5/8" diameter flex line to connect between the gas supply and the appliance manifold pipe, which exists at the upper left rear of the appliance. The appliance manifold pipe connection is 1/2". Use caution to avoid crimping the 5/8" flex line.
- NOTE: the flex line for the gas supply must be metal and approved by an approved certifying agency (AGA, CGA, CSA, UL or CUL). NEVER use a hose made of rubber or other synthetic material as the heat may cause the hose to melt and develop leaks, thus causing fires, physical and property damage.
- Always use pipe dope or Teflon tape on the pipe threads, and be careful not to apply excessive pressure when tightening the fittings.
- Leak testing of the appliance shall be in accordance with the manufacturer's instructions.
- Turn on gas and check supply line connections for leaks using a soap solution. **Never use a flame of any sort to test for leaks.**

CAUTION! The appliance must be isolated from the gas supply piping system by closing its individual manual shut-off valve during any pressure testing of the gas supply piping system at test pressures equal to or less than 112 psig (3.5kPa.).

The Appliance and its individual shut off valve must be disconnected from the gas supply piping system during any pressure testing of the system at test pressures in excess of 1/2 psig (3.5kPa.).

When checking the manifold gas pressure, the inlet pressure to the regulator should be at least 6.0".

DO NOT attempt any adjustment of the pressure regulator.

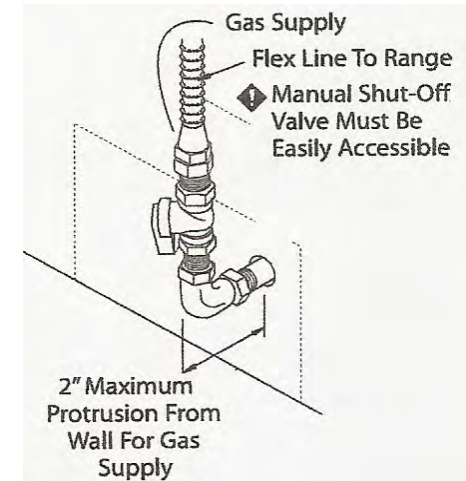

TESTING AND ADJUSTMENTS

Install any loose components, such as burner caps and grates, oven racks that may have been removed earlier to facilitate moving the appliance. Be certain that burner caps seats properly into the alignment slots in the burner bases. Before testing operation of the appliance, verify that the unit and the gas supply have been carefully checked for leaks and that the unit has been connected to the electrical power supply. Turn the manual gas shut-off valve to the open position. Check the operation of the sealed gas burners by pushing and turning each knob counterclockwise to "HI". The burner igniters will click until the flame ignites. Burner flames should be BLUE and stable with no yellow tips, excessive noise, or lifting of the flame from the burner. If any of these conditions exist, check that the air shutter (grill and griddle only) or burner ports are not blocked or clogged. Remove any blockages that exist. If the flame is too yellow, indicating insufficient air, adjust the shutter counterclockwise to increase air inlet (grill and griddle only).

The open top burner flames should be approximately 1" to 1-1/4" High.

CAUTION! A qualified technician must make burner adjustments at the time of installation. Improper or lack of adjustments may cause harmful by-products or void your warranty!

INSTALLER CHECKLIST**FINAL CHECKLIST**

- Placement of unit
- Specified clearances maintained to cabinet surfaces
- Unit Level – front to back – side to side
- Burner caps and retention rings positioned properly on sealed burner bases
- All packing materials removed
- Island trim or back guard attached (if horizontal clearance to combustible materials behind cooking surface is less than 12")
- Check door adjustment and hold down brackets

GAS SUPPLY

- Connection: 1/2" NPT with a minimum of 5/8" diameter flex line
- The appliance is connected only to the type of gas for which it is certified for use
- Manual gas shut-off valve installed in an accessible location (without requiring removal of range)
- Unit tested and free of gas leaks
- Gas supply pressure does not exceed 14" (37 mb) W.C.

ELECTRICAL

- Receptacle with correct over current protection is provided for service cord connection
- Proper ground connection
- Proper polarity at receptacle
- Kick panel in place and 3 screws secure.

OPERATION

- All internal packing materials removed. Check below grates and grill pans and inside the ovens
- If used on Propane gas, verify that the propane gas supply is equipped with its own high-pressure regulator in addition to the pressure regulator supplied with appliance.
- Burner caps properly seated into burner bases.
- Grill Components properly seated (not all models).
- Bezels centered on burner knobs and knobs turn freely.
- Each burner lights satisfactorily, both individually and with other burners operating
- Air shutter adjustment for proper flame made for
- Grill and Griddle sections.
- Griddle is level and does not rock.
- Oven door hinges seated and hinge locks in proper position. Door opens and closes properly.
- Burner grates correctly positioned, level and do not rock.

Note to Customer.

Please make sure installer signs each item on this checklist, explains each item before leaving and explains the range operation to you thoroughly.

SERVICE INFORMATION

If none of the above has occurred, contact our customer service department at 1-866-402-4600.

Before you call for service, please have the following information available:

- Model #
- Serial #
- Date of Installation
- Copy of Receipt or Invoice
- A brief description of the problem

Your satisfaction is our top priority. If the problem persists, or is not resolved to your satisfaction by our service consultant, please write to us or fax us

Capital Cooking Equipment, Inc.
 Attn: Customer Service Manager
 13211 E. Florence Ave
 Santa Fe Springs, CA
 90670
 USA

Fax #: 562-903-1167
 Email: customerservice@capital-cook!ng.com

WARRANTY

ONE (1) Year full parts and labor covers entire product. (Light bulbs covered for 60 days after installation)

FIVE (5) Years limited part replacement warranty. Covers part replacement, as noted below, due to malfunction during normal operation.
 Ranges*, Range Tops*, & Ovens*: All Burners, Heating Elements, Grates*, Griddle Plates, & Oven Racks

Barbeques: Gas Valves & all burners (excluding infrared burners)

*Excludes Porcelain Enamel Coating for ovens and grates. Porcelain enamel is prone to wear over time and use.

LIFETIME warranty (non-transferable) on stainless steel sheet metal body parts against rust. (Excludes damage and normal heat discoloration). Does not include barbeque grates.

WILL PAY FOR:

All repair labor and parts found to be defective due to material or workmanship for one (1) full year" IN HOME" warranty This does not apply if the unit was subjected to other than normal household use. An Authorized Factory Agent must provide service during normal working hours. No charges will be made for repair or replacement at the location of original installation. No charges will be made for defective factory parts returned pre-paid, through the dealer, and claimed within the warranty period. All claims, regardless of warranty or non-warranty must be documented with photos and detailed description and/or narrative of the problem and submitted to Capital's service department.

Replacement of parts will be freight prepaid by Capital and shipped regular ground. Any requests for other than standard ground shipments must be paid by customer. The company will not be liable for additional transportation costs, labor cost, taxes or export/import duties. This warranty shall not apply, nor can we assume responsibility for damage that might result from failure to follow manufacturer's instructions or local codes where the appliance has been tempered with or altered in any way or which, in our judgment, has been subjected to misuse, negligence, or accident. Implied warranty shall not extend beyond the duration of this written warranty. This warranty is in lieu of all warranties, expressed or implied and all other obligations or liability in connection with the sale of this product.

WILL NOT PAY FOR:

- Installation or start-up.
- Shipping damage that is not a direct result of packaging (for example freight handling).
- Service by an unauthorized agency
- Use of unauthorized parts.
- Service during hours other than normal working hours.
- Improper installation.
- Service visit to teach you how to operate the appliance, correct the installation, reset circuit breakers or replace fuses.
- Repair other than normal household use.
- Damage caused by accident, abuse, alteration, misuse, incorrect installation or installation not in accordance with local codes.
- Unit(s) installed in non-residential applications.

This warranty applies to appliances used in residential application only. It does not cover their use in commercial situations. This warranty is for products purchased and retained in the 50 States of the U.S.A, the District of Columbia and Canada. This warranty applies even if you should move during the warranty period. Should the original purchaser sell the appliance during the warranty period, the new owner continues to be protected until the expiration date of the original purchaser's warranty period. This verity gives you the specific legal rights. You may also have other rights, which vary from State to State.

ALL SPECIFICATIONS ARE FOR PLANNING PURPOSES ONLY. REFER TO INSTALLATION INSTRUCTIONS AND CONSULT YOUR COUNTERTOP SUPPLIER PRIOR TO MAKING COUNTER OPENING. IF YOU HAVE ANY QUESTIONS, PLEASE CALL US AT 866-402-4600 PRIOR TO CUTTING ANY OPENINGS. CONSULT WITH A HEATING AND VENTILATING ENGINEER FOR YOUR SPECIFIC VENTILATION REQUIREMENTS. FOR THE MOST UP TO DATE USE AND CARE AND INSTALLATION INSTRUCTIONS CONTACT CAPITAL COOKING EQUIPMENT, INC. INDICATING THE MODEL #.

DUE TO ONGOING PRODUCT IMPROVEMENTS, WE RESERVE THE RIGHT TO CHANGE THESE SPECIFICATIONS, OR DESIGNS WITHOUT NOTICE.



CERTIFIED FOR USA AND CANADA



13211 E Forence Ave. Santa Fe Springs, CA 90670

Toll Free: 866-402-4600

Main: 562-903-1168

Fax: 562-903-1167

Email: customerservice@capital-cooking.com

Website: www.capital-cooking.com