

Pedestal Installation Instructions / Instrucciones de instalación del pedestal / Instructions pour l'installation du socle

Components / Componentes / Composants

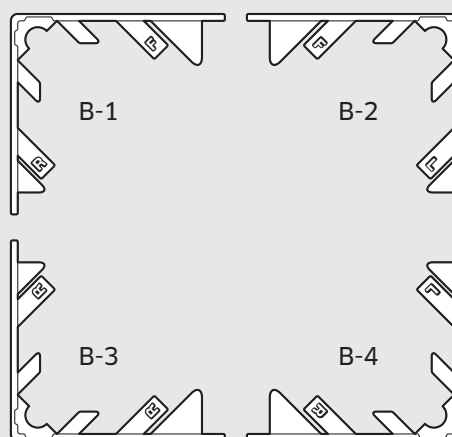
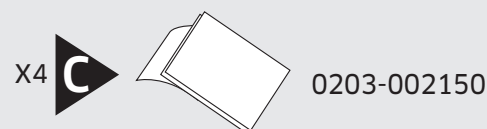
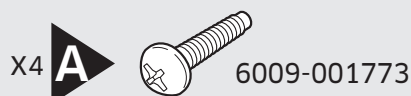
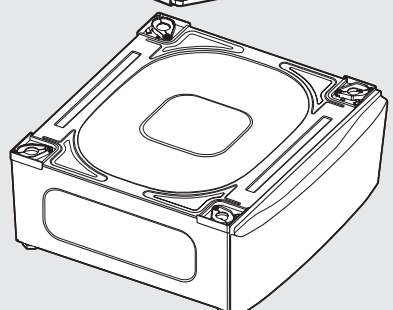
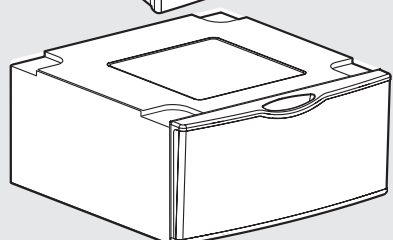
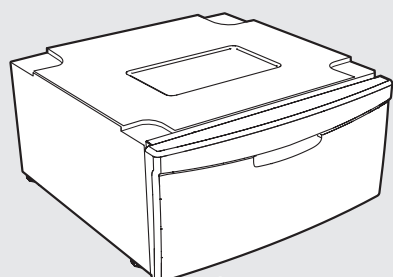

B-1 : GUIDE-COVER FRONT(R) DC61-02933*
B-2 : GUIDE-COVER FRONT(L) DC61-02927*
B-3 : GUIDE-COVER REAR(R) DC61-02932*
B-4 : GUIDE-COVER REAR(L) DC61-02926*

Note: Each Guide Cover is labeled and must be installed in the correct corner of the pedestal.

Nota: Cada guía de la cubierta está rotulada y se debe instalar en la esquina correspondiente del pedestal.

Remarque : Chaque ensemble cache-guide porte une étiquette et doit être installé dans le coin correct du socle.

Tools / Herramientas / Outils



Wrench / Llave inglesa / Clé anglaise

Supplied with Washing Machine or General Wrench (9/16inch or 14mm)
La suministrada con la lavadora o una llave inglesa general (9/16 pulgadas o 14 mm)
Livree avec le lave-linge ou la clé générale (9/16 pouces ou 14 mm)

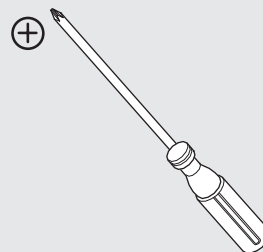

Phillips Screwdriver /
Destornillador Phillips /
Tournevis cruciforme

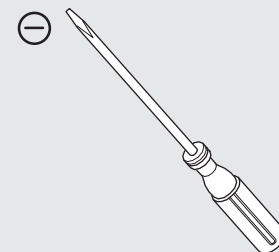

Flat Screwdriver /
Destornillador plano /
Tournevis plat

Code No. : DC68-02931A-04

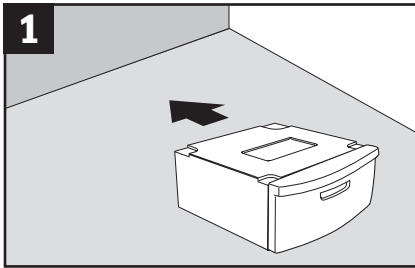

Clean the floor where you intend to install the pedestal, then move the pedestal near where you intend to install it. Make sure to leave yourself space at all four corners so you can access the legs underneath.

Limpie bien el suelo donde vaya a instalar el pedestal y a continuación deposite éste cerca de su lugar de instalación. Deje suficiente espacio en cada una de las cuatro esquinas para que pueda acceder fácilmente a las patas de la parte inferior.

Nettoyez le sol là où vous prévoyez d'installer le socle, puis déplacez le socle à proximité de cet emplacement. Assurez-vous de laisser un espace suffisant aux quatre coins pour pouvoir accéder aux pieds.

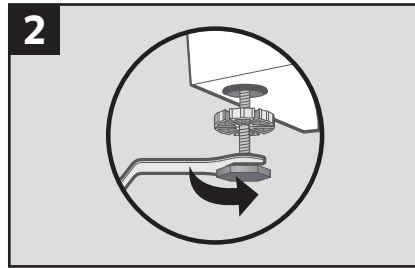

Level the pedestal with a wrench, adjusting all four legs as necessary. Use a level to make sure that the pedestal is level side to side and back to front. Do not tighten the locknuts above the feet at this time.

Nivèle el pedestal con una llave inglesa ajustando las cuatro patas según sea necesario. Use un nivel para que el pedestal esté nivelado de lado a lado y de adelante atrás. No apriete aún la contratuerca que está encima de las patas.

Mettez le socle de niveau avec une clé anglaise en ajustant les quatre pieds. Utilisez un niveau pour vous assurer que le socle est de niveau aussi bien entre les côtés droit et gauche qu'entre l'avant et l'arrière. À ce stade, ne serrez pas les contre-écrous situés au-dessus des pieds.

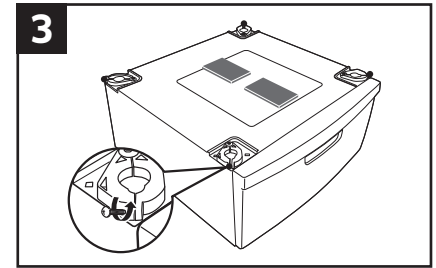

Remove the screw (▶) from each clamp. Retire el tornillo (▶) de cada abrazadera. Retirez la vis (▶) de chaque collier.

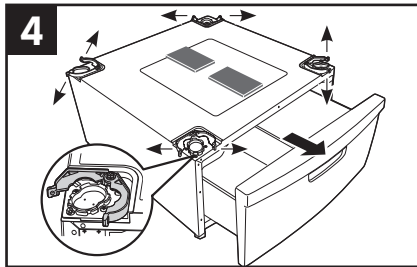

Open the pedestal's drawer fully, and then widen each clamp so you can place the feet of the washer or dryer onto the pedestal properly.

Abra completamente el cajón del pedestal y abra cada una de las abrazaderas para que pueda colocar adecuadamente las patas de la lavadora o la secadora en el pedestal.

Ouvrez le tiroir du socle entièrement, puis élargissez chaque collier afin de pouvoir placer les pieds du lave-linge ou du sèche-linge sur le socle correctement.

▲ Caution / Atención / Attention

Make sure to open the clamps before mounting the washer or dryer on top. Otherwise, the clamps may break.

Asegúrese de abrir las abrazaderas antes de instalar la lavadora o la secadora encima. De lo contrario, las abrazaderas pueden romperse.

Veillez à ouvrir les loquets avant de monter le lave-linge ou le sèche-linge sur le dessus. Sinon, les loquets peuvent se briser.

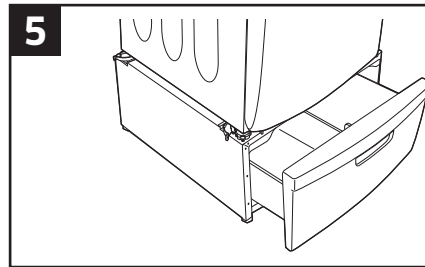

Turn the feet of the washer or dryer so that the feet are as close to the body of the washer or dryer as possible, then lock them in place. Place the washer or dryer onto the pedestal so that the feet rest properly in the clamps. See 5a for the correct placement of the dryer and 5b for the washer.

Gire las patas de la lavadora o la secadora de modo que queden lo más cerca posible de la lavadora o la secadora y, a continuación, asegúrelas en su lugar. Coloque la lavadora o la secadora sobre el pedestal de modo que las patas descansen adecuadamente en las abrazaderas. Vea 5a para la correcta instalación de la secadora y 5b para la lavadora.

Tournez les pieds du lave-linge ou du sèche-linge afin que ceux-ci soient aussi près que possible du corps du lave-linge ou du sèche-linge, puis verrouillez-les. Placez le lave-linge ou le sèche-linge sur le socle de manière que les pieds reposent correctement dans les colliers. Reportez-vous à 5a pour le placement correct du sèche-linge et 5b pour le lave-linge.

▲ Caution / Atención / Attention

To prevent a fall, use caution when mounting the washer or dryer on top of the pedestal.

Para evitar una caída, tenga cuidado al instalar la lavadora o la secadora en el pedestal.

Pour éviter toute chute, soyez attentifs lors du montage du lave-linge ou du sèche-linge sur le dessus du socle.

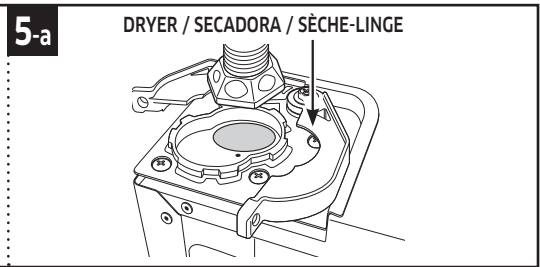

Place the feet of the dryer in the inner circle of the safe landing grooves on the pedestal. The location of the safe landing groove for the dryer is highlighted above.

Coloque las patas de la secadora en el círculo interior de las ranuras de posición segura del pedestal. La ubicación de las ranuras de posición segura de la secadora se destaca en la ilustración superior.

Placez les pieds du sèche-linge dans le cercle intérieur des rainures du socle. L'emplacement de la rainure pour le sèche-linge est signalé ci-dessus.

5-b WASHER / LAVADORA / LAVE-LINGE

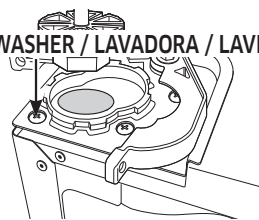

! WARNING / ADVERTENCIA / AVERTISSEMENT

When putting the washer down, take care that the rubber parts of the legs are not damaged by the raised portions of the clamp.

Cuando mueva la lavadora procure que las zonas elevadas de la abrazadera no dañen la parte de goma de las patas.

Lors de la pose du lave-linge, veillez à ce que les pièces en caoutchouc des pieds ne soient pas endommagées par les parties saillantes du collier.

Place the feet of the washer in the outer circle of the safe landing grooves on the pedestal. The location of the safe landing groove for the washer is highlighted above. Coloque las patas de la lavadora en el círculo exterior de las ranuras de posición segura del pedestal. La ubicación de las ranuras de posición segura de la lavadora se destaca en la ilustración superior.

Placez les pieds du lave-linge dans le cercle extérieur des rainures du socle. L'emplacement de la rainure pour le lave-linge est signalé ci-dessus.

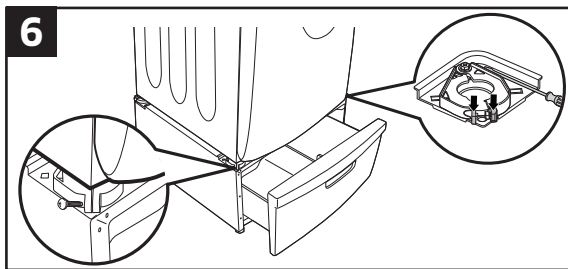

Close and lock the clamps by hand, and then screw an M5 screw (▶) through the screw hole of each clamp to secure the washer or dryer to the pedestal.

Important: You must close and lock each clamp by hand. Do not use a pliers or similar tool to close the clamp. You can break the clamp. If you can't close the clamp by hand, move the washer or dryer slightly, and then try again.

Cierre y asegure manualmente las abrazaderas y a continuación atornille un tornillo M5 (▶) a través del orificio de cada abrazadera para asegurar la lavadora o la secadora en el pedestal.

Importante: Las abrazaderas se deben cerrar y asegurar manualmente. No utilice alicates ni herramientas similares para cerrar la abrazadera. Podría romperla. Si no puede cerrar la abrazadera manualmente, mueva ligeramente la lavadora o la secadora e inténtelo de nuevo.

Fermez et verrouillez les colliers à la main, puis vissez une vis M5 (▶) à travers le trou de vis de chaque collier afin de fixer le lave-linge ou le sèche-linge sur le socle.

Important: vous devez fermer et verrouiller chaque collier à la main. N'utilisez pas de pince ou d'outil similaire pour fermer le collier. Vous risquez de briser ce dernier. Si vous ne parvenez pas à fermer le collier à la main, déplacez légèrement le lave-linge ou le sèche-linge et essayez à nouveau.

▲ Caution / Atención / Attention

If a clamp won't close properly, use the screwdriver instead of pliers to hold down the end of the clamp to close as shown.

Si una abrazadera no cierra correctamente, use un destornillador en vez de unos alicates para presionarla hacia abajo por el extremo tal como se muestra.

Si un loquet ne se ferme pas correctement, utilisez le tournevis au lieu des pinces pour maintenir l'extrémité du loquet pour fermer de la manière indiquée.

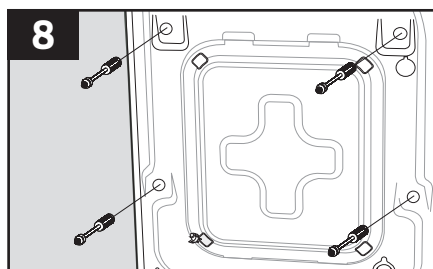

Remove the Shipping bolts from the washing machine.

Retire los tornillos de transporte de la lavadora.

Retirez les vis de transport du lave-linge.

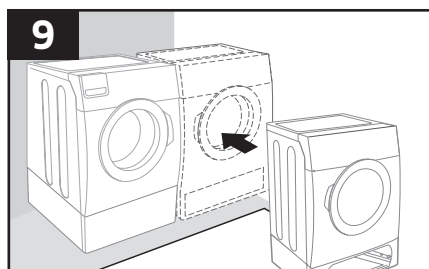

Move the assembled units to their final installation site.

Transporte las unidades ensambladas a su lugar de instalación definitivo.

Déplacez les appareils assemblés à leur emplacement d'installation finale.

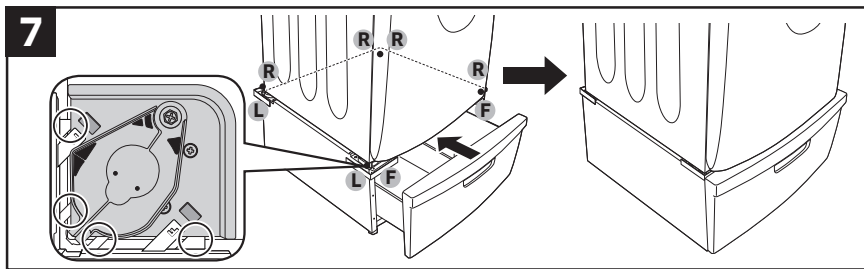

Attach a Guide Cover to each corner of the pedestal. Each Guide Cover is labeled (RF for Right Front, FL or LF for Left Front, RR for Right Rear and LR for Left Rear.) so you can identify the correct corner to attach it to.

To attach a Guide Cover, grasp the tab at the corner of the Guide Cover, and then, holding the Guide Cover at a 45 degree angle, slide the 4 prongs (circled on the Guide Cover in the illustration above) under the clamp area, then flatten and push into place.

After you have attached the Guide Cover, close the drawer.

Fije una guía de cubierta en cada esquina del pedestal. Cada guía de cubierta está rotulada (RF para frontal derecha, FL o LF para frontal izquierda, RR para posterior derecha y LR para posterior izquierda) de modo que le permita identificar en qué esquina debe fijarlas.

Para fijar una guía de cubierta, sujete la lengüeta de la esquina de la guía de cubierta y, manteniendo la guía de cubierta en un ángulo de 45 grados, deslice las 4 puntas (marcadas con un círculo en la guía de cubierta de la ilustración superior) por debajo de la zona de las abrazaderas, aplánelas y colóquelas en su lugar.

Una vez fijadas las guías de cubierta, cierre el cajón.

Fixez une protection sur chaque coin du socle. Chaque protection porte une étiquette (RF pour l'avant droit, FL ou LF pour l'avant gauche, RR pour l'arrière droit et LR pour l'arrière gauche) afin que vous puissiez identifier le coin sur lequel vous devez la fixer.

Pour fixer une protection, saisissez la patte au coin de la protection, puis, tout en maintenant cette dernière à un angle de 45 degrés, faites glisser les 4 languettes (encercleées sur l'illustration ci-dessus) sous la surface du collier, aplatissez la protection et poussez-la en place. Après avoir fixé les protections, fermez le tiroir.

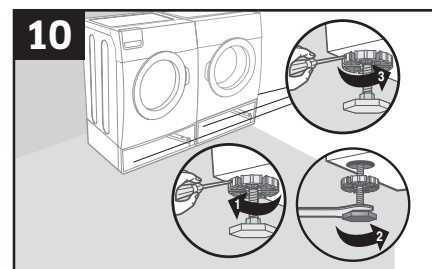

Using a level, make sure the units are level side to side and front to back. Do additional leveling as needed. Proper leveling keeps vibration at a minimum.

Con un nivel, compruebe si las unidades están niveladas de lado a lado y de adelante atrás. Realice la nivelación adicional necesaria. Una nivelación correcta reduce la vibración al mínimo.

Assurez-vous que les appareils sont de niveau de droite à gauche et de l'avant à l'arrière à l'aide d'un niveau. Réglez à nouveau le niveau si nécessaire. Une bonne mise de niveau permet de maintenir les vibrations au minimum.

11

After the washer is fully installed, run a spin test. To run a spin test, put a small load into the washer, wet the clothes, and then select Spin Only mode. If there is too much vibration, repeat Step 10.

Cuando la lavadora esté totalmente instalada, realice una prueba de centrifugado. Para realizar una prueba de centrifugado, ponga una pequeña carga de ropa en la lavadora, mójela y seleccione el modo Spin Only (Sólo centrifugado). Si hay demasiadas vibraciones, repita el paso 10.

Une fois l'installation du lave-linge terminée, lancez un test d'essorage. Pour effectuer un test d'essorage, déposez une faible charge dans le lave-linge, mouillez les vêtements et sélectionnez le mode Essorage seulement. Si les vibrations sont trop importantes, répétez l'étape 10.

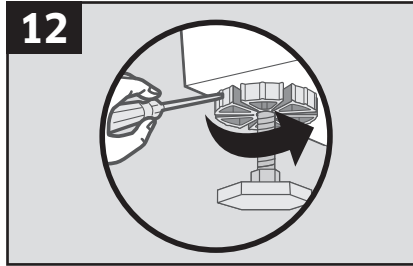
12

Once the washer is stabilized and does not vibrate, tighten the lock nuts on each leg of the pedestal using a flat head screwdriver.

Cuando la lavadora esté estabilizada y no vibre, apriete las tuercas de seguridad de cada pata del pedestal mediante un destornillador plano.

Une fois que le lave-linge est stabilisé et ne vibre pas, serrez les contre-écrous sur chaque pied du socle à l'aide d'un tournevis plat.

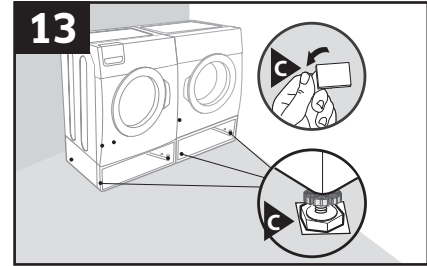
13

When you install the pedestal on smooth floors such as tiles:

- Peel out the double-face tape. Attach it under the all legs.

Lorsque vous posez le socle sur des sols mous tels que des moquettes :

- Décollez la bande autocollante double face. Collez-la sous tous les pieds.

Al instalar el pedestal en superficies lisas revestidas:

- Pele una cinta de doble cara. Péguela bajo todas las patas.

Tips for Installation on Wooden Panel Floors / Sugerencias para la instalación en suelos de paneles de madera / Conseils pour l'installation sur un parquet

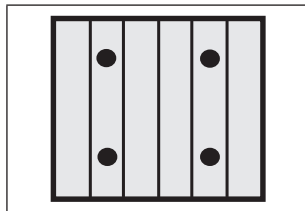

Put the legs on the same floor panels and keep them away from the floor lines.
Ponga las patas sobre los mismos paneles del suelo y apártelas de las líneas del suelo.
Placez les pieds sur les mêmes lames et éloignez-les des joints du plancher.

Warranty

SAMSUNG LAUNDRY PEDESTAL LIMITED WARRANTY TO ORIGINAL PURCHASER

This SAMSUNG brand product, as supplied and distributed by SAMSUNG ELECTRONICS AMERICA, INC.

(SAMSUNG) and delivered new, in the original carton to the original consumer purchaser, is warranted by SAMSUNG against manufacturing defects in materials and workmanship for a limited warranty period of:

One (1) Year All Parts and Labor

This limited warranty begins on the original date of purchase, and is valid only on products purchased and used in the United States. To receive warranty service, the purchaser must contact SAMSUNG for problem determination and service procedures. Warranty service can only be performed by a SAMSUNG authorized service center. The original dated bill of sale must be presented upon request as proof of purchase to SAMSUNG or SAMSUNG's authorized service center. SAMSUNG will provide in-home service during the warranty period at no charge, subject to availability within the contiguous United States.

In-home service is not available in all areas.

To receive in-home service, product must be unobstructed and accessible to the service agent. If service is not available, SAMSUNG may elect to provide transportation of the product to and from an authorized service center.

SAMSUNG will repair, replace, or refund this product at our option and at no charge as stipulated herein, with new or reconditioned parts or products if found to be defective during the limited warranty period specified above. All replaced parts and products become the property of SAMSUNG and must be returned to SAMSUNG. Replacement parts and products assume the remaining original warranty, or ninety (90) days, whichever is longer. This limited warranty covers manufacturing defects in materials and workmanship encountered in normal, noncommercial use of this product and shall not apply to the following: damage that occurs in shipment; delivery and installation; applications and uses for which this product was not intended; altered product or serial numbers; cosmetic damage or exterior finish; accidents, abuse, neglect, fire, water, lightning, or other acts of nature or God; use of products, equipment, systems, utilities, services, parts, supplies, accessories, applications, installations, repairs, external wiring or connectors not supplied or authorized by SAMSUNG that damage this product or result in service problems; incorrect electrical line voltage, fluctuations and surges; customer adjustments and failure to follow operating instructions, maintenance and environmental instructions that are covered and prescribed in the instruction book; product removal and reinstallation; problems caused by pest infestations. This limited warranty does not cover problems resulting from electric current, voltage or supply, light bulbs, house fuses, house wiring, cost of a service call for instructions, or fixing installation errors. SAMSUNG does not warrant uninterrupted or error-free operation of the product.

EXCEPT AS SET FORTH HEREIN, THERE ARE NO WARRANTIES ON THIS PRODUCT EITHER EXPRESS OR IMPLIED, AND SAMSUNG DISCLAIMS ALL WARRANTIES INCLUDING, BUT NOT LIMITED TO, ANY IMPLIED WARRANTIES OF MERCHANTABILITY, INFRINGEMENT OR FITNESS FOR A PARTICULAR PURPOSE. NO WARRANTY OR GUARANTEE GIVEN BY ANY PERSON, FIRM, OR CORPORATION WITH RESPECT TO THIS PRODUCT SHALL BE BINDING ON SAMSUNG. SAMSUNG SHALL NOT BE LIABLE FOR LOSS OF REVENUE OR PROFITS, FAILURE TO REALIZE SAVINGS OR OTHER BENEFITS, OR ANY OTHER SPECIAL, INCIDENTAL OR CONSEQUENTIAL DAMAGES CAUSED BY THE USE, MISUSE, OR INABILITY TO USE THIS PRODUCT, REGARDLESS OF THE LEGAL THEORY ON WHICH THE CLAIM IS BASED, AND EVEN IF SAMSUNG HAS BEEN ADVISED OF THE POSSIBILITY OF SUCH DAMAGES. NOR SHALL RECOVERY OF ANY KIND AGAINST SAMSUNG BE GREATER IN AMOUNT THAN THE PURCHASE PRICE OF THE PRODUCT SOLD BY SAMSUNG AND CAUSING THE ALLEGED DAMAGE. WITHOUT LIMITING THE FOREGOING, PURCHASER ASSUMES ALL RISK AND LIABILITY FOR LOSS, DAMAGE, OR INJURY TO PURCHASER AND PURCHASER'S PROPERTY AND TO OTHERS AND THEIR PROPERTY ARISING OUT OF THE USE, MISUSE, OR INABILITY TO USE THIS PRODUCT. THIS LIMITED WARRANTY SHALL NOT EXTEND TO ANYONE OTHER THAN THE ORIGINAL PURCHASER OF THIS PRODUCT, IS NONTRANSFERABLE AND STATES YOUR EXCLUSIVE REMEDY.

Some states do not allow limitations on how long an implied warranty lasts, or the exclusion or limitation of incidental or consequential damages, so the above limitations or exclusions may not apply to you. This warranty gives you specific rights, and you may also have other rights, which vary from state to state.

To obtain warranty service, please contact SAMSUNG at:

1-800-SAMSUNG (1-800-726-7864)

www.samsung.com