

# Owner's Manual

Double-Drawer  
Built-In Refrigerator

ZIDI240

ZIDS240



*Introduction*

Your new Monogram double-drawer refrigerator makes an eloquent statement of style, convenience and kitchen planning flexibility. Whether you chose it for its purity of design or the assiduous attention to detail, you will find that your Monogram double-drawer refrigerator's superior blend of form and function will delight you for years to come.

The information on the following pages will help you operate and maintain your double-drawer refrigerator properly.

If you have any other questions, visit our Website at: [monogram.com](http://monogram.com)

*Contents*

Care and Cleaning . . . . .	11, 12	Problem Solver . . . . .	13–15
Consumer Services . . . . .	19	Repair Service . . . . .	3, 19
Controls and Features . . . . .	8–10	Safety Instructions . . . . .	4–7
Model and Serial Numbers . . . . .	2	Warranty . . . . .	Back Cover

*Before using your double-drawer refrigerator*

Read this manual carefully. It is intended to help you operate and maintain your new double-drawer refrigerator properly.  
Keep it handy for answers to your questions.

If you don't understand something or need more help, there is a list of toll-free consumer service numbers included in the back section of this manual.

**OR**

Visit our Website at: [monogram.com](http://monogram.com)

*Write down the model & serial numbers*

You will find them on a label on the ceiling inside the double-drawer refrigerator.

**Please write these numbers here:**

\_\_\_\_\_   
Model Number

\_\_\_\_\_   
Serial Number

Use these numbers in any correspondence or service calls concerning your double-drawer refrigerator.

---

*If you received a damaged appliance*

The warranty does not cover damage caused after delivery.

Immediately contact the dealer (or builder) that sold you the double-drawer refrigerator.

---

*Save time & money*

Before you request service, check the Problem Solver in the back of this manual.

It lists causes of minor operating problems that you can correct yourself.

---

*Remove packaging*

Before using, be sure all packing materials and tape have been removed.  
To assure no damage is done to the finish of the product, the safest way to remove the adhesive left from packaging tape on new

appliances is an application of household liquid detergent. Apply with a soft cloth and allow to soak. Wipe dry and then apply an appliance polish to thoroughly clean and protect the surface.

---

*If you need service*

To obtain service, see the Consumer Services page in the back of this manual.

We are proud of our service and want you to be pleased. If for some reason you are not happy with the service you receive, here are steps to follow for further help.

***For customers in the USA:***

FIRST, contact the people who serviced your appliance. Explain why you are not pleased. In most cases, this will solve the problem.

NEXT, if you are still not pleased, write all the details—including your phone number—to:

Manager, Customer Relations  
GE Appliances  
Appliance Park  
Louisville, KY 40225

***For customers in Canada:***

FIRST, contact the people who serviced your appliance. Explain why you are not pleased. In most cases, this will solve the problem.

NEXT, if you are still not pleased, write all the details—including your phone number to:

Manager, Consumer Relations  
Mabe Canada Inc.  
1 Factory Lane, Suite 310  
Moncton, N.B. E1C 9M3

---

*After installation is completed*

- Promptly inspect your new Monogram double-drawer refrigerator. If it has been damaged, contact the Installer or Dealer immediately.
- This double-drawer refrigerator must be properly leveled to ensure correct drawer alignment and drawer closure. Contact the Installer if the unit is not level.
- The unit should be centered in the opening. The front face of the drawer will be flush with adjacent cabinetry. Contact the installer if clearance is not correct.

- Test the drawer. Carefully open and close the drawer. The drawer should not rub or catch on adjacent cabinetry. Notify the installer if the drawer makes contact with cabinetry.

**Please Contact the Installer or Dealer if you experience any of these problems.**

Your custom panel (ZIDI240 model only) double-drawer refrigerator is shipped with two toekicks, a stainless steel and a black toekick. For shipping purposes, one of the toekicks will be secured to the back or on the inside of the unit, and the second will be installed on the unit. Keep the unused toekick and other unused or removed parts for possible future use.

# IMPORTANT SAFETY INSTRUCTIONS

## READ AND SAVE THESE INSTRUCTIONS

### REFRIGERATOR SAFETY INFORMATION

 This is the safety alert symbol. This symbol alerts you to potential hazards that can kill or hurt you and others. All safety messages will follow the safety alert symbol and the word "DANGER", "WARNING", or "CAUTION". These words are defined as:

 **DANGER** Indicates a hazardous situation which, if not avoided, **will** result in death or serious injury.

 **WARNING** Indicates a hazardous situation which, if not avoided, **could** result in death or serious injury.

 **CAUTION** Indicates a hazardous situation which, if not avoided, **could** result in minor or moderate injury.

### IMPORTANT SAFETY INSTRUCTIONS

 **WARNING** To reduce the risk of fire, explosion, electric shock, or injury when using your refrigerator follow these basic safety precautions:

- Double-drawer refrigerators are designed to be built-in only. They cannot be used free-standing.
  - Use this appliance only for its intended purpose as described in this Owner's Manual.
  - This double-drawer refrigerator must be properly installed in accordance with the Installation Instructions before it is used.
  - Do not allow children to climb, stand or hang on the shelves in the double-drawer refrigerator. They could damage the double-drawer refrigerator and seriously injure themselves.
  - Do not store or use gasoline or other flammable vapors and liquids in the vicinity of this or any other appliance.
  - Unplug your double-drawer refrigerator before cleaning or making repairs.
- NOTE:** We strongly recommend that any servicing be performed by a qualified individual.

### IMPORTANT SAFETY INSTRUCTIONS

 **CAUTION** To reduce the risk of injury when using your refrigerator, follow these basic safety precautions.

- Keep fingers out of the "pinch point" areas: clearances between the drawer and between the drawer and cabinet are necessarily small. Be careful closing the drawer when children are in the area.

# IMPORTANTES INSTRUCTIONS DE SÉCURITÉ

## LIRE ET CONSERVER CES INSTRUCTIONS

### CONSIGNES DE SÉCURITÉ POUR LE RÉFRIGÉRATEUR

 Ce symbole représente une alerte de sécurité. Ce symbole vous avise de dangers possibles pouvant causer la mort, des blessures ou autres. Tous les messages de sécurité seront précédés du symbole d'alerte de sécurité ainsi que des mots « DANGER », « AVERTISSEMENT » ou « MISE EN GARDE ». Ces messages sont les suivants :

 **DANGER** Signale une situation qui présente un danger imminent et qui, si elle n'est pas évitée, entraînera des blessures graves, voire la mort.

 **AVERTISSEMENT** Signale une situation qui présente un danger imminent et qui, si elle n'est pas évitée, peut entraîner des blessures graves, voire la mort.

 **MISE EN GARDE** Signale une situation qui présente un danger imminent et qui, si elle n'est pas évitée, peut entraîner des blessures mineures ou graves.

### IMPORTANTES CONSIGNES DE SÉCURITÉ

 **AVERTISSEMENT** Pour réduire le risque d'incendie, d'explosion, de choc électrique ou de blessures lorsque vous utilisez votre réfrigérateur, veuillez suivre ces consignes de sécurité :

- Les réfrigérateurs à deux tiroirs sont conçus pour être encastrés uniquement. Ils ne peuvent pas être séparés.
- N'utilisez l'appareil que pour son usage prévu, comme décrit dans le présent manuel.
- Installez le réfrigérateur à deux tiroirs conformément aux directives d'installation avant de l'utiliser.
- Ne laissez pas les enfants grimper, s'asseoir, se tenir debout ni se pendre aux clayettes du réfrigérateur à deux tiroirs. Ils pourraient endommager le réfrigérateur à deux tiroirs et se blesser gravement.
- N'entreposez et n'utilisez pas d'essence ou autres vapeurs et liquides inflammables à proximité de cet appareil ou de tout autre appareil électroménager.
- Débranchez votre réfrigérateur à deux tiroirs avant de le nettoyer et de le réparer.

**REMARQUE** : Nous vous recommandons vivement de confier toute réparation à un technicien qualifié.

### IMPORTANTES CONSIGNES DE SÉCURITÉ

 **ATTENTION** Pour réduire le risque de blessures lorsque vous utilisez votre réfrigérateur, veuillez suivre ces consignes de sécurité.

- Éloignez les doigts des parties du réfrigérateur où l'on peut facilement se pincer : les espaces entre les tiroirs et entre les tiroirs et les placards sont toujours étroits. Soyez prudent lorsque vous fermez les tiroirs de l'appareil en présence des enfants.

# IMPORTANT SAFETY INSTRUCTIONS

## **⚠ WARNING** Electrical Shock Hazard.

Plug into a grounded 3-prong outlet

Do not remove the ground prong

Do not use an adapter

Failure to follow these instructions can result in death, fire, or electrical shock.

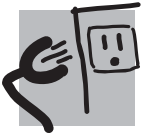

## **Do not, under any circumstances, cut or remove the third (ground) prong from the power cord. For personal safety, this appliance must be properly grounded.**

The power cord of this appliance is equipped with a 3-prong (grounding) plug which mates with a standard 3-prong (grounding) wall outlet to minimize the possibility of electric shock hazard from this appliance.

Have the wall outlet and circuit checked by a qualified electrician to make sure the outlet is properly grounded.

Where a standard 2-prong wall outlet is encountered, it is your personal responsibility and obligation to have it replaced with a properly grounded 3-prong wall outlet. Do not use an adapter.

Use of a GFI (Ground Fault Interrupter) is not recommended for the fresh-food refrigerator.

The refrigerator should always be plugged into its own individual electrical outlet which has a voltage rating that matches the rating plate. This provides the best performance and also prevents overloading house wiring circuits which could cause a fire hazard from overheated wires.

Never unplug your refrigerator by pulling on the power cord. Always grip plug firmly and pull straight out from the outlet.

Repair or replace immediately all power cords that have become frayed or otherwise damaged. Do not use a cord that shows cracks or abrasion damage along its length or at either end.

When moving the refrigerator away from the wall, be careful not to roll over or damage the power cord.



**DO NOT USE AN ADAPTER PLUG TO CONNECT THE FRESH-FOOD REFRIGERATOR TO A 2-PRONG OUTLET.**

## **⚠ WARNING** *RISK OF CHILD ENTRAPMENT*

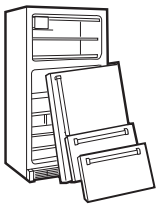

Child entrapment and suffocation are not problems of the past. Junked or abandoned refrigeration products are still dangerous... even if they will sit for "just a few days." If you are getting rid of your old appliance, please follow these instructions to help prevent accidents.

### **Before You Throw Away Your Old Refrigeration Product:**

- Take off the doors.
- Leave the shelves in place so that children may not easily climb inside.

## *REFRIGERANTS*

All refrigeration products contain refrigerants, which under federal law must be removed prior to product disposal.

If you are getting rid of an old refrigeration product, check with the company handling the disposal about what to do.

*READ AND SAVE THESE INSTRUCTIONS*

# IMPORTANTES INSTRUCTIONS DE SÉCURITÉ



AVERTISSEMENT



## Risque de choc électrique.

Branchez l'appareil dans une prise triple avec terre.

Ne retirez pas la broche de terre.

N'utilisez pas d'adaptateur.

Le non-respect de ces instructions peut entraîner des risques d'incendies, des chocs électriques ou la mort.

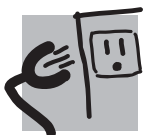

## Ne coupez pas ou n'enlevez pas, sous aucun prétexte, la troisième broche de mise à la terre du cordon d'alimentation. Pour des raisons de sécurité, cet appareil doit être correctement mis à la terre.

Le cordon d'alimentation de cet appareil est équipé d'une fiche à trois broches (pour une mise à la terre) qui s'adapte à la prise de courant standard à 3 broches (pour une mise à la terre) pour minimiser les risques de chocs électriques par cet appareil.

Faites vérifier la prise murale et le circuit électrique par un électricien qualifié pour s'assurer que le système est correctement mis à la terre.

Dans le cas d'une prise biphasée, l'installateur a la responsabilité et l'obligation de la remplacer par une prise triphasée correctement mise à la terre. N'utilisez pas d'adaptateur.

Le réfrigérateur doit toujours être branché à sa propre prise électrique d'une tension nominale correspondant à celle indiquée sur sa plaque signalétique.

Une alimentation électrique à 115 volts CA, 60 Hz, avec un fusible de 15 ou 20 ampères et une mise à la terre est nécessaire. Ceci permet d'obtenir un meilleur rendement et évite de surcharger les circuits électriques du domicile qui risque d'occasionner un incendie en surchauffant.

Ne débranchez jamais le réfrigérateur en tirant sur le cordon d'alimentation. Prenez toujours fermement la fiche en main et tirez pour la sortir de la prise.

Réparez ou remplacez immédiatement tout cordon électrique usé ou endommagé. N'utilisez pas un cordon fissuré ou présentant des dommages dus aux frottements soit sur sa longueur ou aux extrémités.

Lorsque vous éloignez votre réfrigérateur du mur, faites attention à ne pas le faire rouler sur le cordon d'alimentation afin de ne pas l'endommager.



**N'UTILISEZ JAMAIS  
UNE PRISE À  
ADAPTATEUR POUR LE  
RÉFRIGÉRATEUR POUR  
DENRÉES FRAÎCHES  
À UNE PRISE BIPOLAIRE.**



AVERTISSEMENT

## RISQUES POUR LES ENFANTS

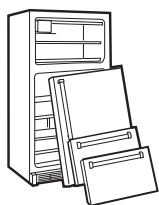

Les enfants pris au piège ou morts d'asphyxie sont toujours d'actualité. Les appareils de réfrigération abandonnés sont toujours aussi dangereux, même si on n'attend que "quelque jours" pour s'en débarrasser. Si vous ne gardez pas votre ancien appareil, veuillez suivre les directives ci-dessous afin de prévenir les accidents.

### Avant de vous débarrasser de votre vieux appareil de réfrigération :

- Démontez les portes.
- Laissez les clayettes en place afin d'empêcher les enfants de grimper à l'intérieur.

## RÉFRIGÉRANTS

Tous les appareils de réfrigération contiennent des réfrigérants qui, conformément aux lois fédérales, doivent être enlevés avant toute élimination de l'appareil.

Si vous vous débarrassez de vieux appareils de réfrigération, vérifiez, auprès de la société qui s'occupe de leur élimination, ce que vous devez faire.

**LISEZ ET CONSERVEZ CES INSTRUCTIONS**

### Temperature control

The temperature display shows the actual temperature of the double-drawer refrigerator. The actual temperature may vary slightly from the set temperature based on factors such as drawer opening, amount of food and room temperature.

**To change the temperature setting**, press the WARMER or COLDER pads until you reach the desired set temperature. After 5 seconds, the display will return to the actual temperature.

Allow 12–24 hours for the double-drawer refrigerator to reach the temperature you have set.

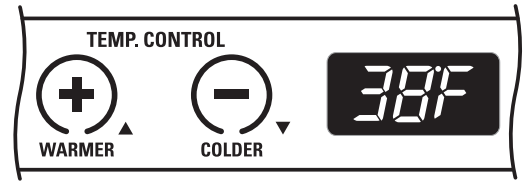

### Temperature Settings

Minimum: 34°F (1.1°C)

Maximum: 45°F (7.2°C)

### Child control lockout

This child control lockout feature prevents unwanted changes to your temperature settings.

After the desired temperature is set, the temperature can be locked. To lock, press both the + and – pads at the same time for five seconds. To unlock, press both + and – pads for five seconds.

### Unit ON/OFF

This pad stops cooling in the double-drawer refrigerator, turns off the temperature controls and removes power to the light circuit.

Press this pad for a minimum of 3 seconds to turn the double-drawer refrigerator on or off or unplug the unit for long vacations or absences, or when cleaning the unit or changing the light bulb.



### Interior fan

The interior fan located in the rear wall of the double-drawer refrigerator may run for extended periods due to usage and ambient temperature. This is normal. See *Normal operating sounds* in *Problem Solver* section for additional information about the fans. The interior fan will turn off when the drawer is opened.



### Glass divider

The top drawer has a moveable, tempered glass divider for separating and organizing foods. The divider can be placed in one of two locations.

**To remove the divider**, lift up until divider clears the rear and front retaining slots.

**To replace the divider**, slide into one of the divider locations.

The glass divider is dishwasher safe, top rack only.

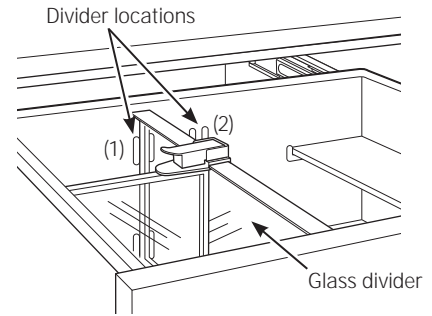

### Snugger

The snugger attached to the glass divider helps prevent tipping, spilling or sliding of small items when the top drawer is opened. Lift the lock down lever near the top of the snugger, then move it to fit your needs. Press the lever down to lock the snugger in place.

The snugger is dishwasher safe, top rack only.

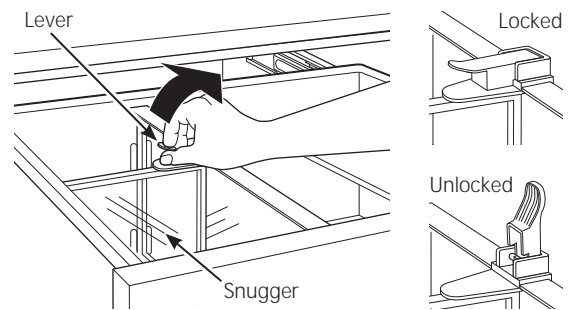

### Assembly instructions

#### To remove:

1. Lift the glass divider assembly out of the drawer by grasping the glass divider and snugger where the lever is located. Sit the assembly on a sturdy surface.
2. Lift the lever.
3. Slide the snugger off the glass divider.
4. Remove the lever from the snugger by lifting the lever up and sliding it down and out of the assembly.

**NOTE:** The glass divider, snugger and lever can be cleaned on the top rack of a dishwasher.

#### To replace or relocate:

1. Reassemble lever into snugger by sliding the lever up into place.
2. Slide glass divider into the snugger. The lever must be installed before sliding the divider into the snugger.
3. Put the glass divider assembly in the desired divider location in the top drawer.

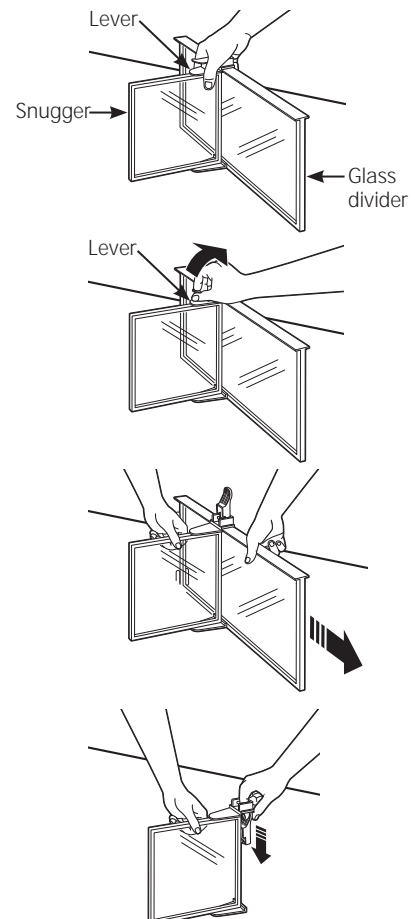

#### *Shelf*

**The top drawer features a shelf** that can fold down for storage of smaller containers, or fold up for storage of larger items on the drawer bottom.

**To fold up the shelf**, lift to the right until it rests in place against the right side.

The shelf is dishwasher safe, top rack only.

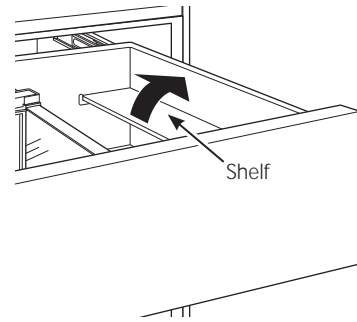

#### *Food storage pan*

**The bottom drawer offers a pan** for storage of smaller items. The pan slides easily to allow storage of and access to larger items in the drawer below.

The pan can be removed, allowing you to carry food to the countertop for preparation or to allow storage space for large food items.

The food storage pan is dishwasher safe, top rack only.

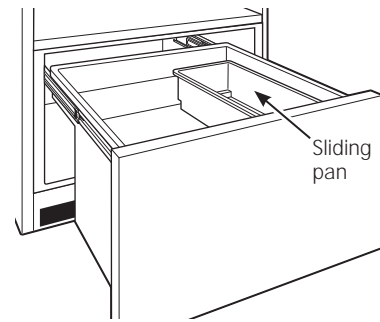

#### *Drawer lights*

**The brilliant full-width LED lighting** in either drawer illuminates when the drawer is opened.

### *For your safety*



#### **Electrical Shock Hazard.**

Turn the double-drawer refrigerator OFF or unplug the unit before cleaning.

Turn the double-drawer refrigerator OFF by pressing the button on the control panel a minimum of 3 seconds until the light turns off.



#### **Risque de choc électrique.**

Éteignez (Off) le réfrigérateur à double tiroir ou débranchez-le avant le nettoyage.

Éteignez (Off) le réfrigérateur à double tiroir en appuyant sur le bouton du panneau de commande durant un minimum de 3 secondes jusqu'à ce que la lampe s'éteigne.

---

### *Drawer gasket*

The vinyl gasket may be cleaned with mild soap and water, or a baking soda solution. Rinse well.

---

### *In the event of a power failure*

If the power fails, open the drawer as infrequently as possible to maintain the temperature.

Do not store or use gasoline or other flammable vapors and liquids in the vicinity of this or any other appliance.

---

### *Preparing for vacation*

For long vacations or absences, remove food and turn the double-drawer refrigerator OFF. Clean the interior (see *Cleaning the Inside* section)

For shorter vacations, remove perishable foods and leave controls at regular settings. However, if the room temperature is expected to drop below 55°F (13°C), follow the same instructions as for long vacations.

---

### *Preparing to move*

Secure all loose items such as the shelf, divider and snugger by taping them securely in place to prevent damage.

**IMPORTANT:** Be sure the double-drawer refrigerator stays in an upright position during moving.

#### *Cleaning the outside*

**Drawer handles and trim**—Clean with a cloth dampened with soapy water. Dry with a soft cloth.

**Keep the outside clean.** Wipe with a clean cloth lightly dampened with mild liquid dish detergent. Dry with a clean, soft cloth.

Do not wipe the refrigerator with a soiled dish cloth or wet towel. These may leave a residue that can damage the finish. Do not use scouring pads, powdered cleaners, bleach or cleaners containing bleach because these products can scratch and damage the finish.

**Stainless steel**—The stainless steel doors and door handles (on some models) can be cleaned with a commercially available stainless steel cleaner. Cleaners with oxalic acid such as Bar Keepers Friend Soft Cleanser™ will remove surface rust, tarnish, and small blemishes. Use only a liquid cleaner free of grit and rub in the direction of the brush lines with a damp soft sponge. Do not use appliance wax or polish on the stainless steel.

#### *Cleaning the inside*

**Unplug the double-drawer refrigerator before cleaning. If this is not practical, turn the unit OFF and wring excess moisture out of the cloth or sponge** when cleaning around switches, lights or controls.

Use warm water and baking soda solution—about a tablespoon (15 ml) of baking soda to a quart (1 liter) of water. This both cleans and neutralizes odors. Thoroughly rinse and wipe dry.

**Other parts of the double-drawer refrigerator**—including the drawer gaskets, divider, snugger, shelf and sliding pan—can be cleaned the same way.

The glass divider, snugger, lever, shelf and food storage pan are dishwasher safe, top rack only.

#### CAUTION

Do not clean glass shelves or covers with warm water when they are cold. Glass shelves and covers may break if exposed to sudden temperature changes or impact, such as bumping or dropping. Tempered glass is designed to shatter into many small pieces if it breaks.

#### ATTENTION

Ne nettoyez pas les clayettes ou les couvercles en verre avec de l'eau tiède quand ceux-ci sont froids. Les clayettes et couvercles en verre peuvent se casser s'ils sont exposés à des changements soudains de température ou si vous les cognez ou les faites tomber. Le verre trempé est conçu pour se briser en petits morceaux en cas de casse.

*Normal operating sounds*

Newer appliances sound different from older appliances. Modern appliances have more features and use newer technology.

*Do you hear what I hear? These sounds are normal.*

**HUMMM...  
WHOOSH...**

- The new high efficiency compressor may run faster and longer than your old appliance and you may hear a high-pitched hum or pulsating sound while it is operating.
- Sometimes the appliance runs for an extended period, especially when the drawers are opened frequently.
- You may hear a whooshing sound when the drawers close. This is due to pressure equalizing within the appliance.
- The cabinet fan runs continuously except when the drawer is opened.



- You may hear the fans spinning at high speeds. This happens when the appliance is first plugged in, when the drawer is opened frequently or when a large amount of food is added to the appliance. The fans help maintain desired temperatures.
- If the drawer is open for over 3 minutes, you may hear the fans come on in order to cool the light bulbs.
- The fans change speeds in order to provide optimal cooling and energy savings.

**CLICKS, POPS,  
CRACKS and CHIRPS**

- You may hear cracking or popping sounds when the appliance is first plugged in. This happens as the appliance cools to the correct temperature.
- Electronic dampers click open and closed to provide optimal cooling and energy savings.
- The electronic control board may cause a clicking sound when relays activate to control appliance components.
- Expansion and contraction of cooling coils during and after defrost can cause a cracking or popping sound.

**WATER SOUNDS**



- The flow of refrigerant through the freezer cooling coils may make a gurgling noise like boiling water.
- Water dropping on the defrost heater can cause a sizzling, popping or buzzing sound during the defrost cycle.
- A water dripping noise may occur during the defrost cycle as ice melts from the evaporator and flows into the drain pan.
- Closing the drawer may cause a gurgling sound due to pressure equalization.

# The Problem Solver

## Double-Drawer Refrigerator

*Questions?  
Use this  
problem  
solver!*

PROBLEM	POSSIBLE CAUSE
APPLIANCE DOES NOT OPERATE	<ul style="list-style-type: none"> <li>• Appliance is so quiet that most of the time you will hear low or no operating noise.</li> <li>• Appliance may be in defrost cycle when compressor motor does not operate for about 30 minutes.</li> <li>• Controls are set to OFF. Press ON/OFF button on control panel for a minimum of 3 seconds.</li> <li>• If interior light is not on, appliance may not be plugged in at wall outlet. Push the plug completely into the wall outlet.</li> <li>• The fuse is blown/circuit breaker is tripped. Replace fuse or reset the breaker.</li> <li>• The appliance is in showroom mode. Unplug it and plug it back in.</li> </ul>
VIBRATION OR RATTLING (Slight vibration is normal.)	<ul style="list-style-type: none"> <li>• Adjust the leveling legs as shown in the Installation Instructions.</li> </ul>
COMPRESSOR MOTOR OPERATES FOR LONG PERIODS OR CYCLES ON AND OFF FREQUENTLY	<ul style="list-style-type: none"> <li>• Normal when appliance is first plugged in. Wait 24 hours for the appliance to completely cool down.</li> <li>• Often occurs when large amounts of food are placed in appliance. This is normal.</li> <li>• Drawer left open or package holding drawer open.</li> <li>• Hot weather or frequent drawer openings. This is normal.</li> <li>• Temperature control set at the coldest setting. See Temperature Control.</li> </ul>
FRESH FOOD OR FREEZER COMPARTMENT TOO WARM	<ul style="list-style-type: none"> <li>• Temperature control not set cold enough. See Temperature Control.</li> <li>• Warm weather or frequent drawer openings.</li> <li>• Drawer left open for long time.</li> <li>• Package may be holding drawer open.</li> </ul>
FROST OR ICE CRYSTALS ON REAR WALL	<ul style="list-style-type: none"> <li>• Too frequent or too long drawer openings.</li> </ul>

## The Problem Solver

### Double-Drawer Refrigerator

*Questions?  
Use this  
problem  
solver!*

PROBLEM	POSSIBLE CAUSE
APPLIANCE HAS ODOR	<ul style="list-style-type: none"> <li>Interior needs cleaning. See Care and Cleaning.</li> <li>Keep open box of baking soda in appliance; replace every 3 months.</li> </ul>
DRAWER NOT CLOSING PROPERLY	<ul style="list-style-type: none"> <li>Drawer gasket is sticking or folding over. Apply petroleum jelly or paraffin wax to the face of the gasket.</li> <li>The drawer is hitting an internal component inside the appliance. Adjust interior components to prevent interference.</li> </ul>
MOISTURE FORMS ON OUTSIDE OF APPLIANCE	<ul style="list-style-type: none"> <li>Not unusual during periods of high humidity. Wipe surface dry.</li> <li>Drawer left open or package holding drawer open.</li> </ul>
MOISTURE COLLECTS INSIDE	<ul style="list-style-type: none"> <li>Too frequent or too long drawer openings.</li> <li>In humid weather, air carries moisture into appliance when drawers are opened.</li> </ul>
INTERIOR LIGHT DOES NOT WORK	<ul style="list-style-type: none"> <li>No power at outlet.</li> <li>Light needs replacing. Call GE Consumer Service at 1.800.444.1845 for light replacement.</li> </ul>
HOT AIR FROM BOTTOM OF APPLIANCE	<ul style="list-style-type: none"> <li>Normal air flow cooling motor. In the refrigeration process, it is normal that heat be expelled in the area under the appliance. Some floor coverings are sensitive and will discolor at these safe and normal temperatures.</li> </ul>
APPLIANCE NEVER SHUTS OFF BUT TEMPERATURES ARE OK ACTUAL TEMPERATURE	<ul style="list-style-type: none"> <li>Adaptive defrost keeps compressor running during drawer openings. This is normal. The appliance will cycle off after the drawer remains closed for 2 hours.</li> <li>Normal operation in extreme temperatures.</li> </ul>
NOT EQUAL TO SET TEMPERATURE	<ul style="list-style-type: none"> <li>Unit just plugged in. Allow 24 hours for the system to stabilize.</li> <li>Drawer open for too long. Allow 24 hours for the system to stabilize.</li> <li>Warm contents added to appliance. Allow 24 hours for the system to stabilize.</li> <li>Defrost cycle is in process. Allow 24 hours for the system to stabilize.</li> </ul>
TEMPERATURE WILL NOT ADJUST	<ul style="list-style-type: none"> <li>Temperature may be in lockout mode. Press both + and – pads for 5 seconds to unlock the temperature.</li> </ul>









***With the purchase of your new Monogram appliance, receive the assurance that if you ever need information or assistance from GE, we will be there. All you have to do is call—toll-free!***

## **GE Answer Center®**

***In the USA:  
800.626.2000***

Whatever your question about any Monogram major appliance, GE Answer Center® information service is available to help. Your call—and your question—will be answered promptly and courteously. And you can call any time. GE Answer Center® service is open 24 hours a day, Monday through Saturday.

**OR**

Visit our Website at: [monogram.com](http://monogram.com)

***In Canada, call 1.800.561.3344.***

## **In-Home Repair Service**

***In the USA:  
800.444.1845***

***In Canada:  
1.800.561.3344***

A GE consumer service professional will provide expert repair service, scheduled at a time that's convenient for you. Many GE Consumer Service company-operated locations offer you service today or tomorrow, or at your convenience (7:00 a.m. to 10:00 p.m. weekdays, 8:00 a.m. to 6:00 p.m. Saturday and Sunday). Our factory-trained technicians know your appliance inside and out—so most repairs can be handled in just one visit.

In Canada: Monday to Friday, 7:00 a.m. to 8:00 p.m. and Saturday 8:00 a.m. to 5:00 p.m. EDST.

## **For Customers With Special Needs...**

***In the USA:  
800.626.2000***

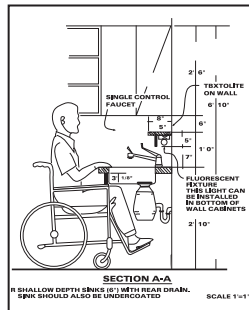

GE offers Braille controls for a variety of GE appliances, and a brochure to assist in planning a barrier-free kitchen for persons with limited mobility.

Consumers with impaired hearing or speech who have access to a TDD or a conventional teletypewriter may call 800.TDD.GEAC (800.833.4322) to request information or service.

## **Service Contracts**

***In the USA:  
800.626.2224***

***In Canada:  
1.800.561.3344***

You can have the secure feeling that GE Consumer Service will still be there after your warranty expires. Purchase a GE contract while your warranty is still in effect and you'll receive a substantial discount. With a multiple-year contract, you're assured of future service at today's prices.

## **Parts and Accessories**

***In the USA:  
800.626.2002***

***In Canada:  
1.800.561.3344***

Individuals qualified to service their own appliances can have parts or accessories sent directly to their home. The GE parts system provides access to over 47,000 parts...and all GE Genuine Renewal Parts are fully warranted. VISA, MasterCard and Discover cards are accepted.

User maintenance instructions contained in this manual cover procedures intended to be performed by any user. Other servicing generally should be referred to qualified service personnel. Caution must be exercised, since improper servicing may cause unsafe operation.

**YOUR MONOGRAM DOUBLE-DRAWER REFRIGERATOR WARRANTY**  
*Staple sales slip or canceled check here. Proof of original purchase date is needed to obtain service under warranty.*

**WHAT IS COVERED**

*From the Date of the Original Purchase*

**LIMITED ONE-YEAR WARRANTY**

For one year from date of original purchase, we will provide, free of charge, parts and service labor in your home to repair or replace *any part of the unit* that fails because of a manufacturing defect.

**LIMITED FIVE-YEAR WARRANTY**

For five years from date of original purchase, we will provide, free of charge, parts and service labor in your home to repair or replace *any part of the sealed refrigerating system* (the compressor, condenser, evaporator and all connecting tubing) that fails because of a manufacturing defect.

This warranty is extended to the original purchaser and any succeeding owner for products purchased for ordinary home use in the 48 mainland states, Hawaii, Washington, D.C. or Canada. If the product is located in an area where service by a GE Authorized Servicer is not available, you may be responsible for a trip charge or you may be required to bring the product to an Authorized GE Service location for service. In Alaska the warranty is the same except that it is LIMITED because you must pay to ship the product to the service shop or for the service technician's travel costs to your home.

All warranty service will be provided by our Factory Service Centers or by our authorized Customer Care® servicers during normal working hours.

Should your appliance need service, during warranty period or beyond, in the USA call 800.444.1845. In Canada: 800.561.3344. Please have your serial number and model number available when calling for service.

**WHAT IS NOT COVERED**

- Service trips to your home to teach you how to use the product.
  - Replacement of house fuses or resetting of circuit breakers.
  - Damage to the product caused by accident, fire, floods or acts of God.
  - Failure of the product if it is used for other than its intended purpose or used commercially.
  - Damage caused after delivery.
  - Improper installation, delivery or maintenance.
  - Replacement of the light bulbs, if included.
  - Loss of food due to spoilage (in the USA only).
  - Incidental or consequential damage caused by possible defects with this appliance.
  - Product not accessible to provide required service.
  - Damage to finish, such as surface rust, tarnish, or small blemishes not reported within 48 hours of delivery.
- If you have an installation problem, contact your dealer or installer. You are responsible for providing adequate electrical, plumbing and other connecting facilities.

**EXCLUSION OF IMPLIED WARRANTIES—Your sole and exclusive remedy is product repair as provided in this Limited Warranty. Any implied warranties, including the implied warranties of merchantability or fitness for a particular purpose, are limited to one year or the shortest period allowed by law.**

Some states/provinces do not allow the exclusion or limitation of incidental or consequential damages, so the above limitation or exclusion may not apply to you. This warranty gives you specific legal rights, and you may also have other rights which vary from state to state/province to province. To know what your legal rights are in your state/province, consult your local or state/provincial consumer affairs office or your state's Attorney General.

Warrantor in USA: General Electric Company,  
Louisville, KY 40225

Warrantor in Canada: Mabe Canada Inc.

197D5891P012  
49-60434-2

09-14 GE  
Printed in Slovenia



**GE Appliances**  
Appliance Park  
Louisville, KY 40225  
GEAppliances.com