

FRIGIDAIRE

All about the

Use & Care

of your Wall Oven



TABLE OF CONTENTS

Welcome & Congratulations	2	Setting Oven Controls - Model B.....	10
Important Safety Instructions.....	3	Care & Cleaning	16
Features at a Glance.....	5	Before You Call	18
Before Setting Oven Controls	7	Major Appliance Warranty	20
Setting Oven Controls - Model A.....	8		

WELCOME & CONGRATULATIONS

Product Registration Register Your Product

The **PRODUCT REGISTRATION CARD** should be filled in completely, signed and returned to Electrolux Major Appliances.

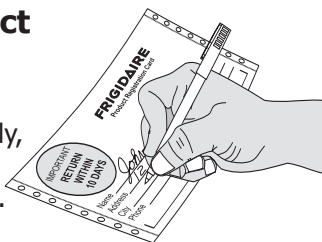

Congratulations on your purchase of a new appliance! At **Electrolux Major Appliances**, we are very proud of our product and are completely committed to providing you with the best service possible. Your satisfaction is our number one priority.

We know you'll enjoy your new appliance and **Thank You** for choosing our product. We hope you consider us for future purchases.

PLEASE CAREFULLY READ AND SAVE THESE INSTRUCTIONS

This Use & Care Manual contains general operating instructions for your appliance and feature information for several models. Your product **may not** have all the described features. The graphics shown are representative. The graphics on your appliance may not look exactly like those shown. These instructions are not meant to cover every possible condition and situation that may occur. Common sense and caution must be practiced when installing, operating and maintaining any appliance.

NOTE

Please attach sales receipt here for future reference.

Serial Plate Location

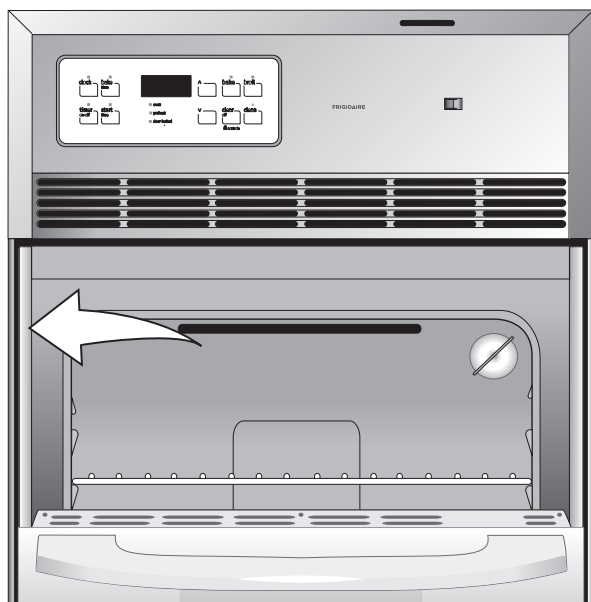

Please record your model and serial numbers below for future reference.

Model Number: _____

Serial Number: _____

Purchase Date: _____

IMPORTANT SAFETY INSTRUCTIONS

Read all instructions before using this appliance.
Save these instructions for future reference.

DEFINITIONS

 This is the safety alert symbol. It is used to alert you to potential personal injury hazards. Obey all safety messages that follow this symbol to avoid possible injury or death.

WARNING

This symbol will help alert you to situations that may cause serious bodily harm, death or property damage.

CAUTION

This symbol will help alert you to situations that may cause bodily injury or property damage.

IMPORTANT

IMPORTANT indicates installation, operation or maintenance information which is important but not hazard-related.

- **Remove all tape and packaging wrap before using the appliance. Destroy the carton and plastic bags after unpacking the appliance.** Never allow children to play with packaging material. Do not remove the wiring label and other literature attached to the appliance. Do not remove model/serial number plate.
- **Proper Installation. Be sure your appliance is properly installed and grounded by a qualified technician in accordance with the National Electrical Code No. 70 - latest edition in the United States, or CSA C22.1, Part 1 in Canada, and local code requirements.** Install only per installation instructions provided in the literature package for this appliance. Ask your dealer to recommend a qualified technician and an authorized repair service. Know how to disconnect the electrical power to the appliance at the circuit breaker or fuse box in case of an emergency.

CAUTION

Electronic controllers can be damaged by cold temperatures. When you use your appliance for the first time, or if it has not been used for a long period of time, make sure that it has been exposed to a temperature above 0°C/32°F for at least 3 hours before connecting it to the power supply.

- **User Servicing. Do not repair or replace any part of the appliance unless specifically recommended in the manuals.** All other servicing should be done only by a qualified technician to reduce the risk of personal injury and damage to the appliance.
- **Never modify or alter the construction of an appliance such as removal of panels, wire covers or any other permanent part of the appliance.**

WARNING



- All appliance can tip.
- Injury to persons could result.
- Install anti-tip bracket packed with your appliance.
- See Installation Instructions.



To reduce the risk of tipping, the appliance must be secured by properly installed anti-tip screws provided with the unit. Refer to the Installation Instructions for proper anti-tip bracket installation.

- **Storage on Appliance. Flammable materials should not be stored near surface units.** This includes paper, plastic and cloth items, such as cookbooks, plasticware and towels, as well as flammable liquids. Do not store explosives, such as aerosol cans, on or near the appliance. Flammable materials may explode and result in fire or property damage.
- **Remove the oven door from any unused appliance if it is to be stored or discarded.**

WARNING

Stepping, leaning, sitting or pulling down on the door of this appliance can result in serious injuries and may also cause damage to the appliance. Do not allow children to climb or play around the appliance.

- **Storage in or on Appliance—Flammable materials should not be stored in an oven.** This includes paper, plastic and cloth items, such as cookbooks, plasticware and towels, as well as flammable liquids. Do not store explosives, such as aerosol cans, in or near the appliance.

WARNING

Do not use the oven for storage.

CAUTION

Do not store items of interest to children in the cabinets above the appliance. Children climbing on the cooktop to reach items could be seriously injured.

- **Do not leave children alone. Children should not be left alone or unattended in the area where an appliance is in use.** They should never be allowed to sit or stand on any part of the appliance.
- **DO NOT TOUCH INTERIOR OVEN ELEMENTS OR INTERIOR SURFACES OF THE OVEN UNTIL THEY HAVE COOLED.** The oven heating elements may be hot even though the elements are dark in color. Areas near the elements may become hot enough to cause burns.

IMPORTANT SAFETY INSTRUCTIONS

During and after use, do not touch, or let clothing or other flammable materials touch these areas until they have had sufficient time to cool. Among these areas are the oven vent openings, the surfaces near these openings, oven door and window.

- **Wear Proper Apparel. Loose-fitting or hanging garments should never be worn while using the appliance.** Do not let clothing or other flammable materials contact hot surfaces.



WARNING

Never use your appliance for warming or heating the room.

- **Do Not Use Water or Flour on Grease Fires. Smother the fire with a pan lid, or use baking soda, a dry chemical or foam-type extinguisher.**
- **When heating fat or grease, watch it closely.** Fat or grease may catch fire if allowed to become too hot.
- **Use Only Dry Pot holders. Moist or damp pot holders on hot surfaces may result in burns from steam.** Do not let the pot holders touch hot surface units. Do not use a towel or other bulky cloth instead of a pot holder.
- **Do Not Heat Unopened Food Containers. Buildup of pressure may cause the container to burst and result in injury.**



IMPORTANT

Do not attempt to operate the appliance during a power failure. If the power fails, always turn off the unit. If the unit is not turned off and the power resumes, the appliance will not operate and an error message will be displayed.

IMPORTANT SAFETY INSTRUCTIONS FOR USING YOUR OVEN

- **Use Care When Opening an Oven Door**—Stand to the side of the appliance when opening the door of a hot oven. Let hot air or steam escape before you remove or replace food in the oven.
- **Keep Oven Vent Ducts Unobstructed.** The wall oven is vented at the center trim under the control panel. Touching the surfaces in this area when the oven is operating may cause severe burns. Also, do not place plastic or heat-sensitive items near the oven vent. These items could melt or ignite.
- **Placement of Oven Racks.** Always place oven racks in desired location while oven is cool. Remove all utensils from the rack before removing rack. If rack must be moved while oven is hot, use extreme caution. Use pot holders and grasp the rack with both hands to reposition. Do not let pot holders contact the hot oven element or interior of the oven.

- **Do not use a broiler pan without its insert.** Broiler pan and grid allow dripping fat to drain and be kept away from the high heat of the broiler.
- **Do not cover the broiler grid or oven bottom with aluminum foil.** Exposed fat and grease could ignite.
- **Do not touch a hot oven light bulb with a damp cloth.** Doing so could cause the bulb to break. Disconnect the appliance or shut off the power to the appliance before removing and replacing the bulb.
- **Protective liners**—Do not use aluminum foil to line the oven bottom. Only use aluminum foil as recommended in this manual. Improper installation of these liners may result in risk of electric shock, or fire.

IMPORTANT SAFETY INSTRUCTIONS FOR CLEANING YOUR OVEN

- **Clean the appliance regularly to keep all parts free of grease that could catch fire.** Exhaust fan ventilation hoods and grease filters should be kept clean. Do not allow grease to accumulate. Greasy deposits in the fan could catch fire. Refer to the hood manufacturer's instructions for cleaning.
- **Cleaners/Aerosols**—Always follow the manufacturer's recommended directions for use. Be aware that excess residue from cleaners and aerosols may ignite causing damage and/or injury.
- **Clean in the self-cleaning cycle only the parts of the appliance listed in this Owner's Guide.** Before using the self-cleaning cycle of the appliance, remove all utensils stored in the appliance.
- **Do not clean the oven door gasket.** The door gasket is essential for a good seal. Care should be taken not to rub, damage or move the gasket.
- **Do not use oven cleaners.** No oven cleaner or oven liner protective coating of any kind should be used in or around any part of the appliance.



CAUTION

The health of some birds is extremely sensitive to the fumes given off during the self-clean cycle of any wall oven. Move birds to another well ventilated room.



IMPORTANT SAFETY NOTICE

The California Safe Drinking Water and Toxic Enforcement Act requires the Governor of California to publish a list of substances known to the state to cause cancer, birth defects or other reproductive harm, and requires businesses to warn customers of potential exposure to such substances.

FEATURES AT A GLANCE (MODEL A)

Your Electric Wall-Oven Features:

1. Oven vent.
2. Electronic oven control with kitchen timer.
3. Oven light switch.
4. Broil element.
5. Oven interior light with removable cover.
6. Manual clean oven interior.
7. Adjustable interior oven rack(s).
8. Large 1-piece oven door handle.
9. Full width oven door with window.
10. Bottom trim.

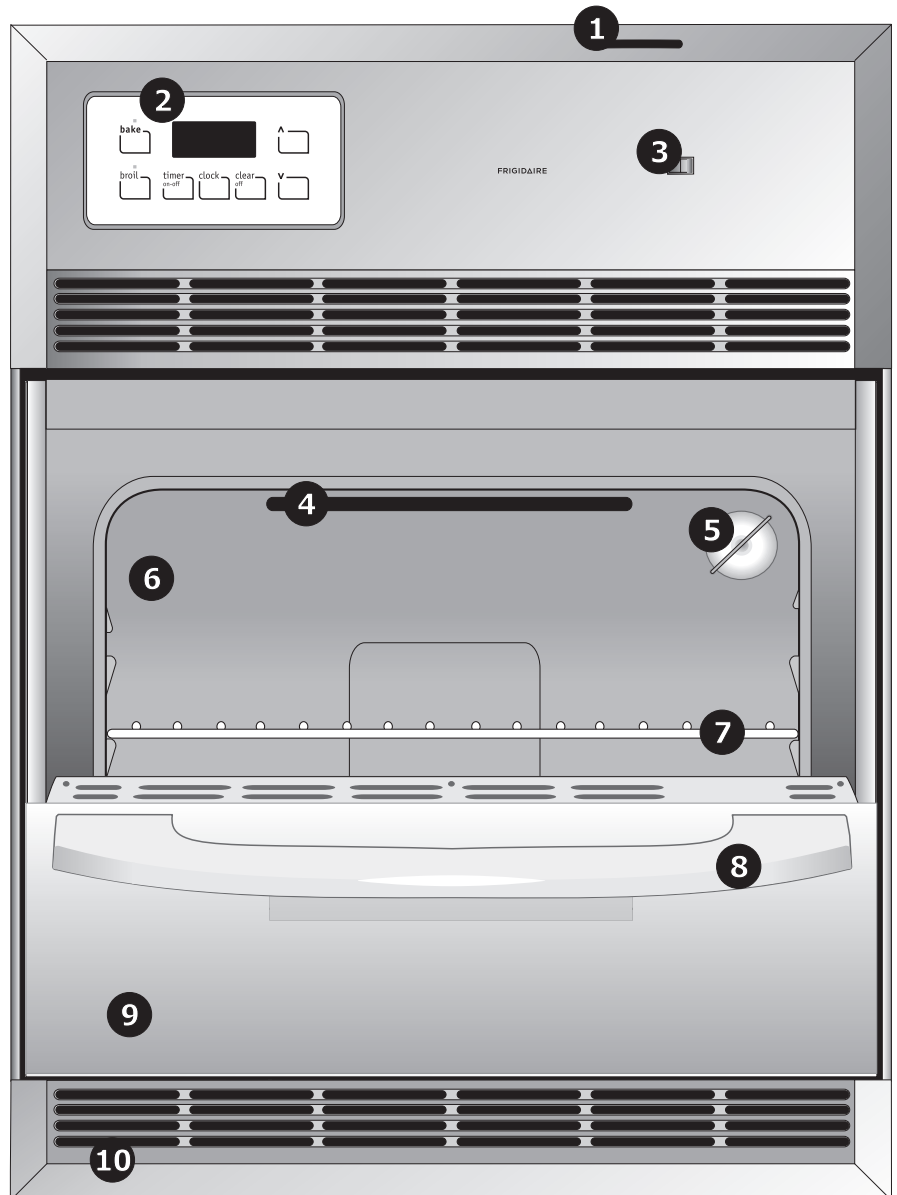

NOTE

The features shown for your appliance may vary according to model type & color.

FEATURES AT A GLANCE (MODEL B)

Your Electric Wall-Oven Features:

1. Oven vent.
2. Electronic oven control with kitchen timer.
3. Oven light switch.
4. Broil element.
5. Oven interior light with removable cover.
6. Self-cleaning oven interior.
7. Adjustable interior oven rack(s).
8. Large 1-piece oven door handle.
9. Full width oven door with window.
10. Bottom trim.

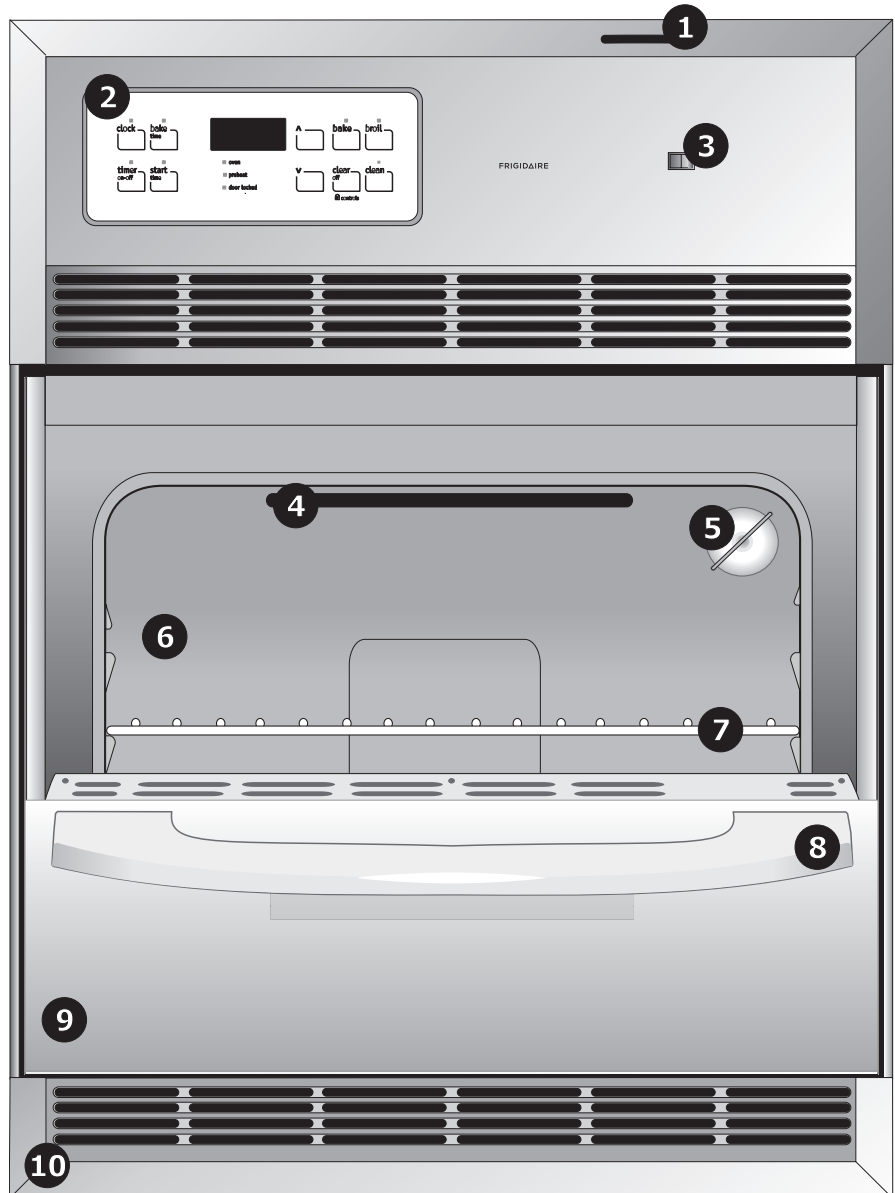

NOTE

The features shown for your appliance may vary according to model type & color.

BEFORE SETTING OVEN CONTROLS

Oven Vent Location

The oven is vented **at the center trim**. When the oven is on, warm air is released through the vent. This venting is necessary for proper air circulation in the oven and good baking results.

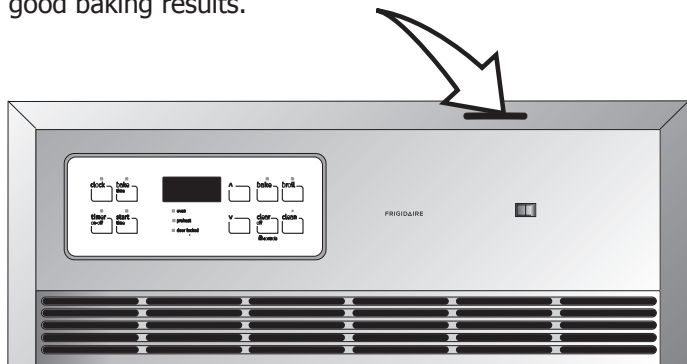

CAUTION

Some models are equipped with a blower which runs in baking and self-cleaning mode to keep all internal components at a cool temperature. The blower may keep running even if the oven has been turned off, until the components have cooled down.

Air Circulation in the Oven

If using 1 rack, place in center of oven. If using multiple racks, stagger cookware as shown.

For best air circulation and baking results allow 2-4" (5-10cm) around the cookware for proper air circulation and be sure pans and cookware do not touch each other, the oven door, sides or back of the oven cavity. The hot air must circulate around the pans and cookware in the oven for even heat to reach around the food.

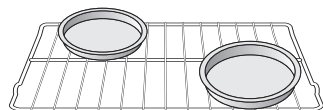

Single Oven Rack

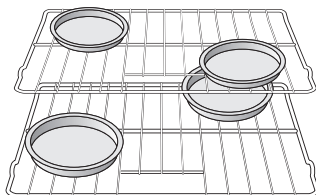

Multiple Oven Racks

Arranging Oven Racks

ALWAYS ARRANGE OVEN RACKS WHEN THE OVEN IS COOL (PRIOR TO OPERATING THE OVEN). Always use oven mitts when using the oven.

To remove an oven rack, pull the rack forward until it stops. Lift up front of rack and slide out.

To replace an oven rack, fit the rack onto the guides on the oven walls. Tilt the front of the rack upward and slide the rack back into place.

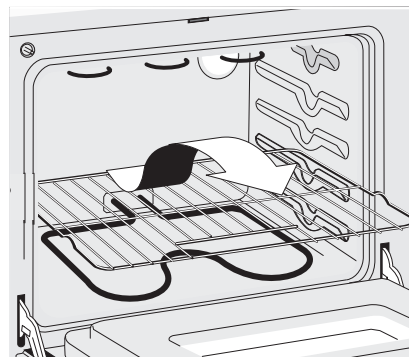

Recommended Rack Position

Food	Rack Position
Broiling meats, chicken or fish	3 or 4
Cookies, cakes, pies, biscuits & muffins	
Using a single rack	2 or 3
Using two racks	2 and 4
Frozen pies, angel food cake, yeast, bread, 1 or 2 casseroles, small cuts of meat or poultry	1 or 2
Turkey, roast or ham	1

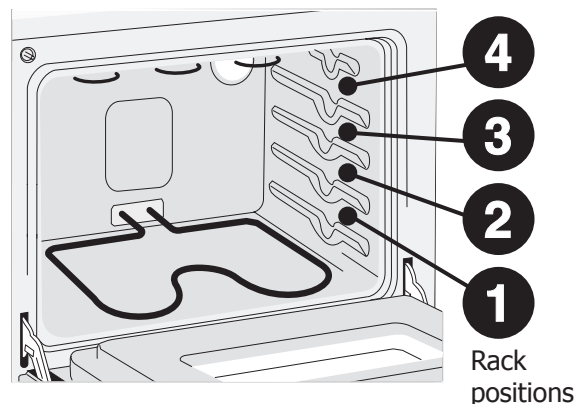

Rack positions

NOTE

Always use caution when removing food from the oven.

SETTING OVEN CONTROLS - MODEL A

Control pad features

READ THE INSTRUCTIONS CAREFULLY BEFORE USING THE OVEN. For satisfactory use of your oven, become familiar with the various features and functions of the oven as described below. **Detailed instructions for each feature and function follow later in this Use & Care Guide.**

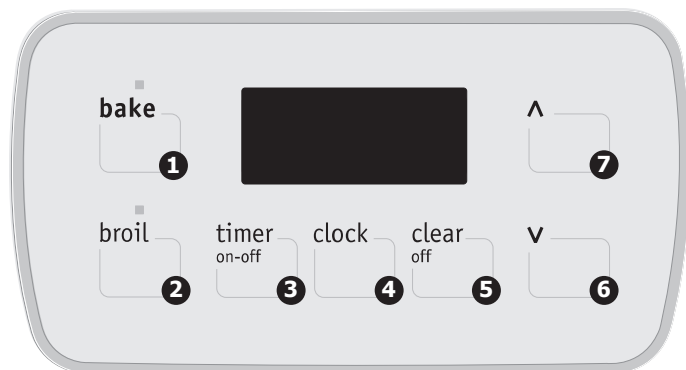

- 1. Bake pad**—Use to select the bake cooking feature.
- 2. Broil pad**—Use to select the broil cooking feature.
- 3. Timer on-off pad**—Use to set or cancel the Timer. The Timer does not start or stop cooking.
- 4. Clock pad**—Use to set the time of day.
- 5. Clear off pad**—Use to cancel any oven feature previously entered except the time of day and minute timer.
- 6. Down arrow pad**—Used along with the function pads to select oven temperature, time of day and minute timer.
- 7. Up arrow pad**—Used along with the function pads to select oven temperature, time of day and minute timer.

To Set the Clock

When the appliance is first plugged in, or when the power supply to the range has been interrupted, the display will flash "12:00".

1. Press **CLOCK** pad.
2. Within 4 seconds, press and hold the **UP** or **DOWN ARROW** pad until the correct time of day appears in the display.

To Change the Temperature Display Mode

The electronic oven control temperature display mode was factory preset to display (Fahrenheit) °F oven temperatures. Note: Oven cooking temperatures may be set from 170°F to 500°F (76°C to 260°C).

To change the Temperature Display Mode to °C (Celsius) or from °C to °F (do not use Bake or Broil while changing the Temperature Display Mode):

1. Press & hold the **BROIL** pad for 7 seconds until F or C appears in the display. **Note:** At this time the display will show the current Temperature Display Mode whether set for F or C.
2. Within 4 seconds, press the **UP** or **DOWN ARROW** pad once to toggle between the °F (Fahrenheit) and °C (Celsius).
3. To accept the change, wait 5 more seconds until the oven control beeps once. To complete the change skip step 4 below, OR;
4. If at any time during the process of changing the Temperature Display Mode (F or C) you decide the change is not desired, press the **CLEAR OFF** pad before the oven control beeps once to cancel the process.
5. The display will then return to the time of day with any temperature display mode change you may have requested.

To Set the Minute Timer

1. Press **TIMER ON/OFF** pad.
2. Press the **UP ARROW** pad to increase the time in one minute increments. Press and hold the **UP ARROW** pad to increase the time faster. The timer can be set for any amount of time from 1 minute to 11 hours and 59 minutes. **Note:** If you press the **DOWN ARROW** pad first, the timer will advance to 11 hours and 59 minutes.
3. The display shows the timer count down in minutes until one minute remains. Then the display will count down in seconds.
4. When the set time has run out, the timer will sound a 3 seconds beep. 0:00 will appear in the display until **TIMER ON/OFF** pad is pressed.

Note: While the minute timer is counting down, the ":" will flash. The minute timer does not start or stop cooking. It serves as an extra timer in the kitchen that will beep when the set time has run out. The minute timer can be used alone or during any of the other oven functions. When the minute timer is in use with any other function, the minute timer will be shown in the display. To view other functions, press the pad for that function.

To Change the Minute Timer while it is in use:

While the timer is active and shows in the display, press and hold the **UP** or **DOWN ARROW** pad to increase or decrease the time.

To Cancel the Minute Timer before the set time has run out: Press **TIMER ON/OFF**.

SETTING OVEN CONTROLS - MODEL A

To Set or Change the Temperature for Baking

The oven can be programmed to bake at any temperature from 170°F to 500°F (76°C to 260°C).

To Set the Controls for Baking:

1. Press **BAKE** pad. "— — —°" appears in the display.
2. Within 5 seconds, press the **UP** or **DOWN ARROW** pad. The display will show "350°F." By pressing and holding the **UP** or **DOWN ARROW** pad, the temperature can then be adjusted in 5°F increments.
3. When the **UP** or **DOWN ARROW** pad is released, the oven will begin heating to the selected temperature. When the displayed temperature reaches the desired baking temperature, the control will beep once (1 time).
4. To cancel the baking function, press **CLEAR OFF** pad.

To Change the Oven Temperature after Baking has Started:

1. Press **BAKE** pad and make sure the bake temperature is displayed.
2. Press the **UP** or **DOWN ARROW** pad to increase or decrease the set temperature.

To Broil

1. Arrange oven rack while oven is still cool.
2. Press **BROIL** pad.
3. Press and hold the **UP** or **DOWN ARROW** pad until the desired broil setting level appears in the display. Press the **UP ARROW** pad for HI broil or the **DOWN ARROW** pad for LO broil. Most foods can be broiled at the HI broil setting. Select the LO broil setting to avoid excess browning or drying of foods that should be broiled to the well-done stage.
4. Place the insert on the broiler pan, then place the food on the insert. DO NOT use the broiler pan without the insert or cover the insert with aluminum foil. The exposed grease could ignite.
5. Place the pan on the oven rack. Open the oven door to the broil stop position when broiling.
6. Broil on one side until food is browned; turn and cook on the second side. Note: Always pull the rack out to the stop position before turning or removing food.
7. When broiling is finished, press **CLEAR OFF** pad.



CAUTION

Should an oven fire occur, close the oven door and turn off the oven. If the fire continues, use a fire extinguisher. DO NOT put water or flour on the fire. Flour may be explosive.

Adjusting Your Oven Temperature

Your new oven has been factory calibrated and tested to ensure an accurate baking temperature. For the first few uses, follow your recipe times and temperature recommendations carefully. If you feel your oven is too hot or too cool from your baking experience, the oven temperature may be adjusted to your liking.

NOTE

DO NOT adjust your oven temperature based on oven thermometers, such as those found in grocery stores, they may not be accurate.

To Adjust the Oven Temperature (do not use Bake or Broil while adjusting the oven temperature):

Note: Your oven control was factory set in the (Fahrenheit) °F Temperature Display Mode. To change for (Celsius) °C, see page 15.

1. Press & hold the **BAKE** key pad and release after the display shows the factory temperature setting of 00. **Note:** If the oven temperature has been previously adjusted from the factory setting, the current temperature adjusted value will appear in the display instead.
2. You may increase the oven temperature in 5°F (1°C) increments with each press of the **UP ARROW** pad to a maximum oven adjustment of +35°F (+18°C). You may also adjust the oven temperature downward in 5°F (1°C) increments with each press of the **DOWN ARROW** pad (total range of -35°F to +35°F (-18°C to +18°C)).
3. If you do not want to keep the display adjustment, press the **CLEAR OFF** pad before the oven control beeps. This will cancel the temperature adjustment procedure. To start this procedure over again begin with step 1 above OR;
4. If you want to keep the adjustment, wait until the oven control beeps once.
5. The oven temperature adjustment has been accepted by the oven control and the display will return to the time of day.

Failure Modes

All failure modes give a visual and audible alarm. When display shows F10 (temperature runaway), F30-F31 (oven sensor circuit fault) or any other F error codes, the electronic oven control has detected a fault condition. Note that code and push the CLEAR OFF pad to clean the display and stop the beeping. Reprogram the oven. If fault recurs, push CLEAR OFF pad, disconnect the appliance to prevent damage and contact an authorized servicer.

SETTING OVEN CONTROLS - MODEL B

Control pad features

READ THE INSTRUCTIONS CAREFULLY BEFORE USING THE OVEN. For satisfactory use of your oven, become familiar with the various features and functions of the oven as described below. **Detailed instructions for each feature and function follow later in this Use & Care Guide.**

NOTE

The oven function will not work if the time of day clock is not set.

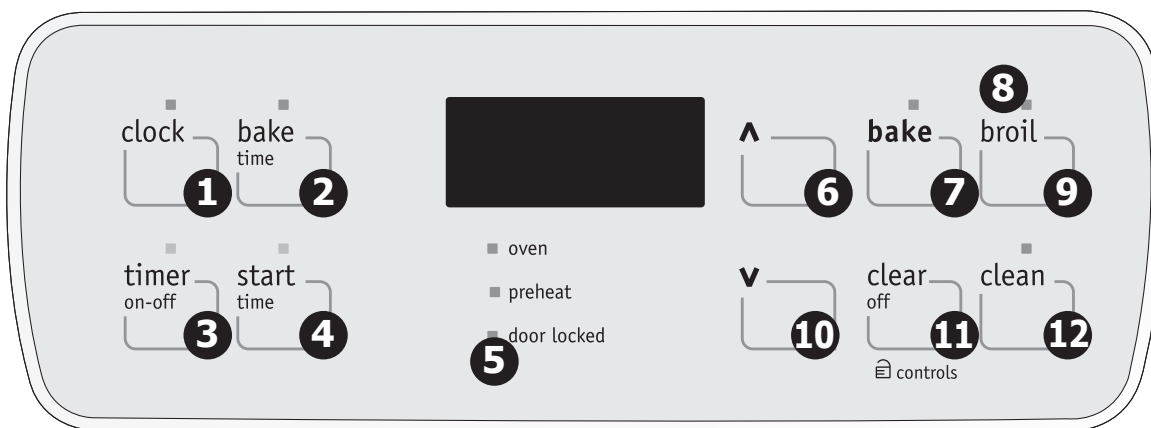

- 1. Clock pad**—Use to set the time of day.
- 2. Bake time pad**—Use to enter the length of the baking time.
- 3. Timer on-off pad**—Use to set or cancel the Timer. The Timer does not start or stop cooking.
- 4. Start time pad**—Used to set the desired start time for baking. Can be used with BAKE TIME to program a delayed bake cycle.
- 5. Oven, preheat & door locked lights**— The "oven" light will glow each time the oven unit turns on to maintain the set oven temperature. The "Preheat" light will glow when the oven is first set to operate, or if the desired temperature is reset higher than the actual oven temperature. The "Door Locked" light will flash until the door locks when the self-clean cycle is in use. It glows constantly after the door locks.

- 6. Up arrow pad**—Used along with the function pads to select oven temperature, time of day and minute timer.
- 7. Bake pad**—Use to select the bake cooking feature.
- 8. Feature indicator lights**—These light to show which feature is in use.
- 9. Broil pad**—Use to select the broil cooking feature.
- 10. Down arrow pad**—Used along with the function pads to select oven temperature, time of day and minute timer.
- 11. Clear off pad**—Use to cancel any oven feature previously entered except the time of day and minute timer.
- 12. Clean Pad**—Used to select the self-cleaning cycle.

The oven can be programmed to

Bake normally, Time Bake, Delayed Bake, Broil, Self-Clean
Note: Push buttons or pads may be shaped differently.

For a silent control panel

When choosing a function, a beep will be heard each time a pad is pushed. If desired, the controls can be programmed for silent operation. Push and hold START TIME pad. After 7 seconds, the control will beep once. This will block the controls from sounding when a pad is pushed. To return the sound, push and hold START TIME pad again for 7 seconds until 1 beep is heard.

Temperature Conversion (Fahrenheit/Celsius)

The electronic oven control is set to operate in °F (Fahrenheit) when shipped from the factory. The oven can be programmed for any temperature from 170°F to 550°F (77°C to 287°C).

To change the temperature to °C (Celsius) or from °C to °F (control should not be in a Bake or Clean mode):

1. Push **BROIL** pad. "- - -" appears in the display.
2. Push and hold the **UP ARROW** pad until "HI" appears in the display.
3. Push and hold **BROIL** pad until °F or °C appears in the display.
4. Push **UP** or **DOWN ARROW** pad to change °F to °C or °C to °F.
5. To accept the change, wait 6 seconds.

SETTING OVEN CONTROLS - MODEL B

NOTE

The oven function will not work if the time of day clock is not set.

To Set the Clock

When the range is first plugged in, or when the power supply to the appliance has been interrupted, the display will flash "12:00".

1. Push **CLOCK** pad.
2. Within 5 seconds, push and hold the **UP** or **DOWN ARROW** pad until the correct time of day appears in the display.
Note: The clock cannot be changed during any timed bake or self-clean cycle.

To Set the Minute Timer

1. Push **TIMER ON/OFF** pad.
2. Push the **UP ARROW** pad to increase the time in one minute increments. Push and hold the **UP ARROW** pad to increase the time in 10 minute increments. The timer can be set for any amount of time from 1 minute to 11 hours and 59 minutes.
Note: If you push the **DOWN ARROW** pad first, the timer will advance to 11 hours and 59 minutes.
3. The display shows the timer count down in minutes until one minute remains. The display will count down in seconds.
4. When the set time has run out, the timer will beep 3 times. It will continue to beep 3 times every 60 seconds until the **TIMER ON/OFF** pad is pushed.

NOTE

The minute timer does not start or stop cooking. It serves as an extra timer in the kitchen that will beep when the set time has run out. The minute timer can be used alone or during any of the other oven functions. When the minute timer is in use with any other mode, the minute timer will be shown in the display. To view other functions, push the function pad for that mode.

To Change the Minute Timer while it is in use:

While the timer is active and shows in the display, push and hold the UP or DOWN ARROW pad to increase or decrease the time.

To Cancel the Minute Timer before the set time has run out: Push **TIMER ON/OFF** pad.

NOTE

To turn the time of day display OFF or ON in the display press and hold the **CLOCK** pad for 8 seconds (the control will beep once) and then release. This feature does not remove the set time of day from the memory of the control. When the display is turned OFF the time of day will reappear for a few seconds any time the **CLOCK** pad is touched.

To Set Control for Continuous Bake or 12 Hour Energy Saving

The oven control has a built-in 12 Hour Energy Saving feature that will shut off the oven if the control is left on for more than 11 hours and 59 minutes. The oven can be programmed to override this feature for continuous baking.

To set control for continuous baking:

1. Push and hold **TIMER ON/OFF** pad down for 5 seconds until tone is heard, "— — hr" will appear in display for continuous cooking. The current time of day will return to the display.
2. To cancel the Continuous Bake Function, push **TIMER ON/OFF** pad and hold for 5 seconds until tone is heard. "12hr" will appear in display indicating that the control has returned to the 12 Hour Energy Saving feature.

To Set Control for Oven Lockout

The control can be programmed to lock the oven door and inactivate the oven controls.

To Set Control for Oven Lockout feature:

1. Push the **CLEAR OFF** pad and hold for 3 seconds. "Loc" will appear in display, the "Door Locked" indicator light will flash and the motor driven door lock will begin to close automatically. **DO NOT** open oven door while the indicator light is flashing. Allow about 15 seconds for the oven door to lock. Once the oven door is locked, the current time of day will appear in the display.
2. To cancel the lockout feature, push **CLEAR OFF** pad and hold for 3 seconds. The control will unlock the oven door and resume normal operation.

NOTE

If a control pad is pressed while the Oven Door/Control Lockout mode, "Loc" will appear in the display until the control pad is released. But it does not disable the clock, kitchen timer and the interior oven lights.

SETTING OVEN CONTROLS - MODEL B

To Set or Change the Temperature for Normal Baking

The oven can be programmed to bake at any temperature from 170°F to 550°F (77°C to 287°C).

NOTE

The oven control has a built-in energy saving feature that will shut off the oven if the control is left on for more than 11 hours 59 minutes.

To Set the Controls for Normal Baking:

1. Push **BAKE** pad. "— — —" appears in the display.
2. Within 5 seconds, push the **UP** or **DOWN ARROW** pad. The display will show "350°F (177°C)." By holding the **UP** or **DOWN ARROW** pad, the temperature can then be adjusted in 5°F (1°C) increments.
3. As soon as the **UP** or **DOWN ARROW** pad is released, the oven will begin heating to the selected temperature. When the oven temperature reaches the desired baking temperature, the control will beep 3 times and the Preheat light will turn off.
4. To cancel the baking function, push the **CLEAR OFF** pad.

To Change the Oven Temperature after Baking has started:

1. If you are using the minute timer, push the **BAKE** pad and make sure the bake temperature is displayed.
2. Push the **UP** or **DOWN ARROW** pad to increase or decrease the set temperature.

Setting Broil

This mode is best for meats, fish and poultry up to 1" thick. Broiling is a method of cooking tender cuts of meat by direct heat under the broil element of the oven. The high heat cooks quickly and gives a rich, brown outer appearance. The **BROIL** pad controls the Broil feature. An optional Searing Grill, Broiler Pan and Insert are available via the enclosed accessories brochure (Figure 1 & 2). The optional broil pan and broil pan insert used together allow dripping grease to drain and be kept away from the high heat of the oven broiler.

Broiling Tips:

- For optimum browning, preheat the broil element for 5 minutes.
- Broil one side until the food is browned; turn and cook on the second side. Season and serve.
- Always pull the rack out to the "stop" position before turning or removing food.
- Always use the broiler pan and its cover when broiling. It allows the dripping grease to be kept away from the high heat of the broil element (see Figure 1).
- For best broiling results, broil with the oven door in the broil stop position (see Figure 3).

- If using a Searing Grill (available by mail order), preheat the grill for 5 to 10 minutes before placing your meat.
- **DO NOT** use the broil pan without the insert. **DO NOT cover the broil pan insert with foil.** The exposed grease could catch fire.

Accessories available via the enclosed brochure:

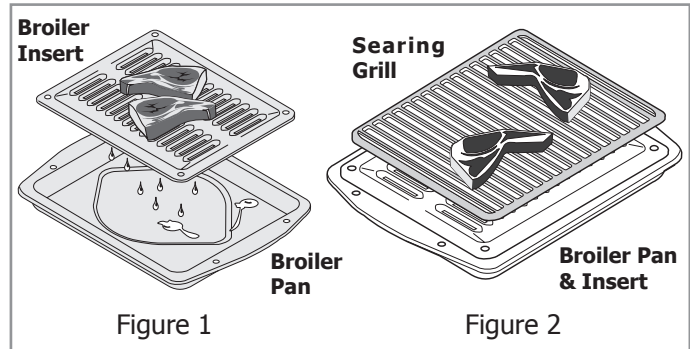

To set the Broil:

1. Arrange oven rack while oven is still cool.
2. Push the **BROIL** pad.
3. Push and hold the **UP** or **DOWN ARROW** pad until the desired broil setting level appears in the display. Push **UP ARROW** pad for HI broil or the **DOWN ARROW** pad for LO broil. Most foods can be broiled at the HI broil setting. Select the LO broil setting to avoid excess browning or drying of foods that should be cooked to the well-done stage.
4. Place grid on the broiler pan, then place the food on the grid. **DO NOT** use the broiler pan without the grid or cover the grid with aluminum foil. The exposed fat could ignite.
5. Place the pan on the oven rack. Open the oven door to the broil stop position when broiling (Figure 3).
6. Broil on one side until food is browned; turn and cook on the second side. Note: Always pull the rack out to stop position before turning or removing food.
7. When broiling is finished, push the **CLEAR OFF** pad.

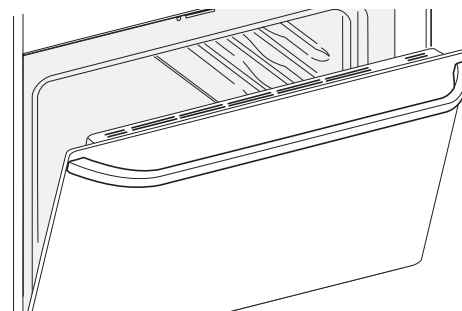

Broil Stop Position
Figure 3

CAUTION

Should an oven fire occur, close the oven door and turn off the oven. If the fire continues, use a fire extinguisher. **DO NOT** put water or flour on the fire. Flour may be explosive.

SETTING OVEN CONTROLS - MODEL B

To Set the Bake time Feature

The BAKE TIME and START TIME controls operate the Timed Bake Feature. The automatic timer will turn the oven on and off at the times you select in advance. The oven can be programmed to start immediately and shut off automatically or to begin baking at a later time with an automatic shut off.

To Program the Oven to Begin Baking Immediately and To Shut Off Automatically:

1. Be sure that the clock shows the correct time of day.
2. Place the food in the oven and push the **BAKE** pad.
3. Within 5 seconds, push the **UP** or **DOWN ARROW** pad. The display will show "350°F (177°C)." By holding the UP or DOWN ARROW pad, the temperature can then be adjusted in 5°F (1°C) increments.
4. Push the **BAKE TIME** pad. "0:00" will flash in the display.
5. Push the UP or DOWN ARROW pad until the desired amount of baking time appears in the display.

To Program Oven for a Delayed Start Time and to Shut-Off Automatically:

1. Be sure that the clock shows the correct time of day.
2. Place the food in the oven and push the **BAKE** pad.
3. Within 5 seconds, push the **UP** or **DOWN ARROW** pad. The display will show "350°F (177°C)." By holding the **UP** or **DOWN ARROW** pad, the temperature can then be adjusted in 5°F (1°C) increments.
4. Push the **BAKE TIME** pad. "0:00" will flash in the display.
5. Push the **UP** or DOWN ARROW pad until the desired amount of baking time appears.
6. Push the **START TIME** pad.
7. Push the **UP** or **DOWN ARROW** pad until the desired start time appears in the display.
8. Once the controls are set, the control calculates when baking will stop.

Once the Controls are Set:

1. The oven will come on and begin heating to the selected baking temperature.
2. The oven temperature (or time of day) will show in the display.

When the Set Bake Time Runs Out:

1. "END" will appear in the display window and the oven will shut off automatically.
2. The control will beep 3 times every 60 seconds until the CLEAR OFF pad is pushed.

To Change the Oven Temperature or Bake Time after Baking has started:

1. Push the function pad you want to change.
2. Push the **UP** or **DOWN ARROW** pad to adjust the setting.



CAUTION

Use caution when using the automatic timer. Use the automatic timer when cooking cured or frozen meats and most fruits and vegetables. Foods that can easily spoil such as milk, eggs, fish, meat or poultry, should be chilled in the refrigerator first. Even when chilled, they should not stand in the oven for more than 1 hour before cooking begins, and should be removed promptly when cooking is completed.

Recalibrating Your Oven Temperature

Recalibrating Your Oven Temperature

The temperature in the oven has been set at the factory. When first using the oven, be sure to follow recipe times and temperatures. If you think the oven is too hot or too cool, the temperature in the oven can be adjusted. Before adjusting, test a recipe by using a temperature setting that is higher or lower than recommended temperature. The baking results should help you to decide how much of an adjustment is needed.

To Adjust Oven Temperature:

1. Push the BAKE pad.
2. Set the temperature to 550°F (287°C) by pushing and holding the UP ARROW pad.
3. Within 2 seconds, push and hold the BAKE pad until the special 2 digit display appears. Release the BAKE pad. The display now indicates the amount of degrees offset between the original factory temperature setting and the current temperature setting. If the oven control has the original factory calibration, the display will read "00."
4. The temperature can now be adjusted up or down 35°F (17°C), in 5°F (1°C) steps by pushing and holding the UP or DOWN ARROW pad. Adjust until the desired amount of degrees offset appears in the display. When lowering the oven temperature, a minus sign (-) will appear before the number to indicate that the oven will be cooler by the displayed amount of degrees.
5. When you have made the desired adjustment, push the CLEAR OFF pad to go back to the time of day display.



NOTE

The adjustment made will not change the self-cleaning temperature.

SETTING OVEN CONTROLS - MODEL B

Self-cleaning

A self-cleaning oven cleans itself with high temperatures (well above normal cooking temperatures) which eliminate soils completely or reduces them to a fine powdered ash you can wipe away with a damp cloth.

➔ IMPORTANT

Adhere to the following cleaning precautions:

- **DO NOT** use oven cleaners or oven protective coatings in or around any part of the oven interior.
- **DO NOT** clean the oven door gasket. The woven material of the oven door gasket is essential for a good seal. Care should be taken not to rub, damage or remove the gasket.
- **DO NOT** use any cleaning materials on the oven door gasket. Doing so could cause damage.
- **Remove the broiler pan and insert, all utensils and ANY ALUMINUM FOIL. These items cannot withstand high cleaning temperatures and will melt.**
- **Completely remove ALL OVEN RACKS and ANY ACCESSORIES. If the oven racks are not removed, they will lose their special coating properties and will no longer slide in and out of the oven cavity effortlessly.**
- **Remove any excessive spillovers** in the oven cavity **before** starting the Self-Cleaning cycle. To clean, use hot, soapy water and a cloth. Large spillovers can cause heavy smoke or fire when subjected to high temperatures. **DO NOT** allow food spills with a high sugar or acid content (such as milk, tomatoes, sauerkraut, fruit juices or pie filling) to remain on the surface as they may leave a dull spot even after cleaning.
- Clean any soil from the oven frame, the door liner outside the oven door gasket and the small area at the front center of the oven bottom. These areas heat sufficiently to burn soil on. Clean with soap and water.



What to Expect during Cleaning

While the oven is in operation, the oven heats to temperatures much higher than those used in normal cooking. Sounds of metal expansion and contraction are normal. Odor is also normal as the food soil is being removed. Smoke may appear through the oven vent.

If heavy spillovers are not wiped up before cleaning, they may flame and cause more smoke and odor than usual. This is normal and safe and should not cause alarm. If available, use an exhaust fan during the self-cleaning cycle.

! CAUTION

To avoid possible burns use care when opening the oven door after the Self-Cleaning cycle. Stand to the side of the oven when opening the door to allow hot air or steam to escape.

During the Self-Cleaning cycle, the outside of the range can become very hot to the touch. **DO NOT** leave small children unattended near the appliance.

The health of some birds is extremely sensitive to the fumes given off during the Self-Cleaning cycle of any range. Move birds to another well-ventilated room.

DO NOT line the oven walls, racks, bottom or any other part of the range with **aluminum foil**. Doing so will destroy heat distribution, produce poor baking results and cause permanent damage to the oven interior (aluminum foil will melt to the interior surface of the oven).

DO NOT force the oven door open. This can damage the automatic door locking system. Use caution when opening the door after the Self-Cleaning cycle is completed. The oven may still be **VERY HOT**.

📌 NOTE

See additional cleaning information for the oven door in the **General Care & Cleaning** section.

SETTING OVEN CONTROLS - MODEL B

Self-cleaning

To Start the Self-Clean Cycle

*We recommend a 2 hour self-clean cycle for light soils, and a 3 hour cycle for average to heavy soils (to assure satisfactory results).

To Set the Controls for a Self-Clean Cycle:

1. Be sure the clock shows the correct time of day.
2. Push the CLEAN pad. "--" appears in the display.
3. Push the UP ARROW pad until "3:00" appears in the display for a 3 hour cycle, or push the DOWN ARROW pad until "2:00" appears in the display for a 2 hour cycle.
4. As soon as the UP or DOWN ARROW pad is released, "CLn" appears in the display.
5. As soon as the controls are set, the motor driven lock will begin to close automatically and the "Door Locked" indicator light will flash. DO NOT open the door while the light is flashing (it takes about 15 seconds for the lock to close).
6. The "Door Locked" light will glow until the cleaning cycle is completed or cancelled, and the oven temperature has cooled.

When the Self-Clean Cycle is Completed:

1. The time of day will appear in the display window and the "Door Locked" light will continue to glow.
2. Once the oven has cooled down for about 1 hour and the "Door Locked" light has gone out, the oven door can be opened.

Stopping or Interrupting a Self-Cleaning Cycle If it becomes necessary to stop or interrupt a self-cleaning cycle due to excessive smoke or fire:

1. Push the CLEAR OFF pad.
2. Once the oven has cooled down for about 1 hour and the "Door Locked" light has gone out, the oven door can be opened.
3. Correct the condition which caused the smoking.
4. Restart the self-clean cycle once all conditions have been corrected.



CAUTION

Use care when opening the oven door after self-cleaning cycle. Stand to the side of the oven when opening the door to allow hot air or steam to escape.

DO NOT force the oven door open. This can damage the automatic door locking system. Use caution when opening the door after the self-cleaning cycle is completed. The oven may still be VERY HOT.

FAILURE MODES

All failure modes give a visual and audible alarm. When display shows F10 (temperature runaway), F30 (oven sensor circuit fault) or F90 (motor door lock fault), the electronic oven control has detected a fault condition. Note that code and push the CLEAR OFF pad to clean the display and stop the beeping. Reprogram the oven. If fault recurs, push CLEAR OFF pad, disconnect the appliance to prevent damage and contact an authorized servicer.

CARE & CLEANING

Cleaning Various Parts of Your Range

Before cleaning any part of the range, be sure all controls are turned OFF and the range is COOL. REMOVE SPILLOVERS AND HEAVY SOILING AS SOON AS POSSIBLE. REGULAR CLEANING WILL REDUCE THE NUMBER OF MAJOR CLEANING LATER.

SURFACE TYPE	RECOMMENDATION
<ul style="list-style-type: none">• Aluminum & Vinyl	Use hot, soapy water and a cloth. Dry with a clean cloth.
<ul style="list-style-type: none">• Painted and plastic control knobs• Painted body parts• Painted decorative trims	Using a soft cloth, clean with mild dish detergent and water or a 50/50 solution of vinegar and water. Follow by rinsing the area with clean water; dry and polish with a soft cloth. Glass cleaners may be used if sprayed on a soft cloth first. DO NOT spray liquids directly on the control pad and display area. Do not use large amounts of water on the control panel - excess water on the control area may cause damage to the appliance. Do not use other liquid cleaners, abrasive cleaners, scouring pads, or paper towels - they will damage the finish. To remove control knobs, turn to the OFF position; grasp firmly and pull straight off the shaft. To replace knobs after cleaning, line up the flat sides of both the knob and the shaft; then push the knob into place.
<ul style="list-style-type: none">• Stainless Steel (some models) Oven Door & Drawer Front Panel and Decorative Trim	Clean stainless steel with hot, soapy water and a dishcloth. Rinse with clean water and a cloth. Do not use cleaners with high concentrations of chlorides or chlorines. Do not use harsh scrubbing cleaners. Only use kitchen cleaners that are especially made for cleaning stainless steel. Always be sure to rinse the cleaners from the surface as bluish stains may occur during heating that cannot be removed.
<ul style="list-style-type: none">• Porcelain enamel broiler pan and insert (available by mail order)• Door liner & body parts	Gentle scouring with a soapy scouring pad will remove most spots. Rinse with a 1:1 solution of clear water and ammonia. If necessary, cover difficult spots with an ammonia-soaked paper towel for 30 to 40 minutes. Rinse with clean water and a damp cloth, and then scrub with a soap-filled scouring pad. Rinse and wipe dry with a clean cloth. Remove all cleaners or the porcelain may become damaged during future heating. DO NOT use spray oven cleaners on the cooktop.
<ul style="list-style-type: none">• Oven racks	Oven racks must be removed from oven cavity. Clean by using a mild, abrasive cleaner following manufacturer's instructions. Rinse with clean water and dry.
<ul style="list-style-type: none">• Oven door	Use soap & water to thoroughly clean the top, sides and front of the oven door. Rinse well. You may use a glass cleaner on the outside glass of the door. Do not immerse the door in water. Do not spray or allow water or the glass cleaner to enter the door vents. Do not use oven cleaners, cleaning powders or any harsh abrasive cleaning materials on the outside of the oven door. Do not clean the oven door gasket. On self-clean models, the oven door gasket is made of a woven material which is essential for a good seal. Care should be taken not to rub, damage or remove this gasket.

Care and cleaning of stainless steel

Some models are equipped with stainless steel exterior parts. Special care and cleaning are **required** for maintaining the appearance of stainless parts. Refer to the **General Care & Cleaning** table for detailed cleaning instructions.

Removing and replacing the lift-off oven door

CAUTION

The door is heavy. For safe, temporary storage, lay the door flat with the inside of the door facing down.

To Remove Oven Door:

1. Open oven door completely (horizontal with floor - See Figure 1).
2. Pull the door hinge locks on both left and right door hinges down from the oven frame completely towards the oven door (See Figure 2). A tool such as a small flat-blade screwdriver may be required.
3. Firmly grasp both sides of oven door along the door sides (Do not use the oven door handle - See Figure 3).
4. Close the door to the broil stop position (the oven door will stop into this position just before fully closing).
5. With the oven door in the broil stop position, lift the oven door hinge arms over the roller pins located on each side of the oven frame (See Figure 4).

To Replace Oven Door:

1. Firmly grasp both sides of oven door along the door sides (Do not use the oven door handle - See Figure 3).
2. Holding the oven door at the same angle as the removal position, seat the hook of the hinge arm over the roller pins located on each side of the oven door frame (See Figure 4). The hook of the hinge arms must be fully seated onto the roller pins.
3. Fully open the oven door (horizontal with floor - See Figure 1).
4. Push the door hinge locks up towards and into the oven frame on both left and right oven door hinges (See Figure 2) to the locked position.
5. Close the oven door.

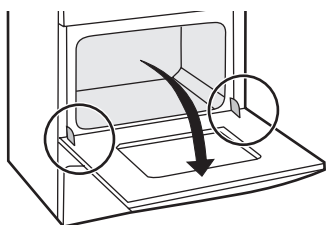

Door Hinge locations with oven door fully open

Figure 1

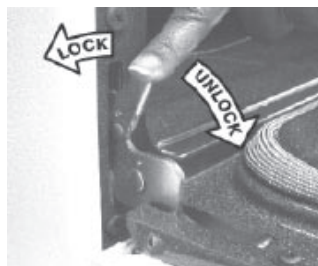

Figure 2

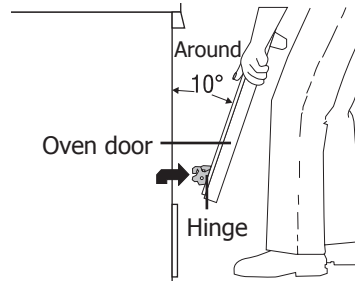

Figure 3

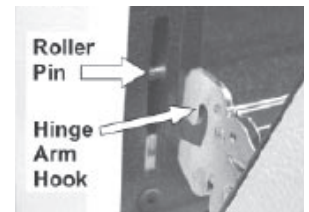

Figure 4

Special door care instructions - Most oven doors contain glass that can break.

Read the following recommendations:

1. Do not close the oven door until all the oven racks are fully in place.
2. Do not hit the glass with pots, pans, or any other object.
3. Scratching, hitting, jarring or stressing the glass may weaken its structure causing an increased risk of breakage at a later time.

Changing oven light

CAUTION

Be sure the oven is unplugged and all parts are COOL before replacing the oven light bulb. Do not turn the oven light on during a self-cleaning cycle. High temperature will reduce lamp life.

On some models an interior oven light will turn on automatically when the oven is opened. The oven light may be turned on when the door is closed by using the oven light switch located on the Electronic Oven control. The oven light bulb is covered with a glass shield held in place by a wire holder. THIS GLASS SHIELD MUST ALWAYS BE IN PLACE WHEN THE OVEN IS IN USE.

CAUTION

BE SURE OVEN IS COOL

To Replace the Light Bulb:

1. Turn the power off at the main source.
2. Wear a leather-faced glove for protection against possible broken glass.
3. Replace bulb with a 40 Watt appliance bulb only.
4. For self-cleaning oven, press wire holder to one side to release glass shield, change bulb and be sure to replace glass shield.







BEFORE YOU CALL - Solutions to Common Problems

Oven Baking

For best cooking results, heat the oven before baking cookies, breads, cakes, pies or pastries, etc. There is no need to preheat the oven for roasting meat or baking casseroles.

The cooking times and temperatures needed to bake a product may vary slightly from your previously owned appliance.

Baking Problems and Solutions Chart

BAKING PROBLEMS	CAUSES	CORRECTIONS
<p>Cookies and biscuits burn on the bottom.</p> 	<ul style="list-style-type: none"> • Cookies and biscuits put into the oven before the preheating time is completed. • Oven rack overcrowded. • Dark pan absorbs heat too fast. 	<ul style="list-style-type: none"> • Allow oven to preheat to the selected temperature before placing food in oven. • Choose pan sizes that will permit 5.1cm to 10.2cm (2" to 4") of air space on all sides when placed in the oven. • Use a medium-weight aluminum baking sheet.
<p>Cakes too dark on top or bottom.</p> 	<ul style="list-style-type: none"> • Cakes put into the oven before preheating time is completed. • Rack position too high or low. • Oven too hot. 	<ul style="list-style-type: none"> • Allow oven to preheat to the selected temperature before placing food in the oven. • Use proper rack position for baking needs. • Set oven temperature 25°F/12°C lower than recommended.
<p>Cakes not done in the center.</p> 	<ul style="list-style-type: none"> • Oven too hot. • Incorrect pan size. • Pan not centered in oven. 	<ul style="list-style-type: none"> • Set oven temperature 25°F/12°C lower than recommended. • Use pan size suggested in recipe. • Use proper rack position and place pan so there is 5.1cm to 10.2cm (2" to 4") of space on all sides of pan.
<p>Cakes not level.</p> 	<ul style="list-style-type: none"> • Range not level. • Pan too close to oven wall or rack overcrowded. • Pan warped. 	<ul style="list-style-type: none"> • Place a marked glass measuring cup filled with water on the center of the oven rack. If the water level is uneven, refer to the installation instructions for leveling the range. • Be sure to allow 5.1cm to 10.2cm (2" to 4") of clearance on all sides of each pan in the oven. • Do not use pans that are dented or warped.
<p>Foods not done when cooking time is up.</p> 	<ul style="list-style-type: none"> • Oven too cool. • Oven overcrowded. • Oven door opened too frequently. 	<ul style="list-style-type: none"> • Set oven temperature 25°F/12°C higher than suggested and bake for the recommended time. • Be sure to remove all pans from the oven except the ones to be used for baking. • Open oven door only after shortest recommended baking time.

BEFORE YOU CALL - Solutions to Common Problems

IMPORTANT

Before you call for service, review this list. It may save you time and expense. The list includes common occurrences that are not the result of defective workmanship or materials in this appliance.

OCCURRENCE	POSSIBLE CAUSE/SOLUTION
Oven Control Beeps and Displays an "F" Error Code	Electronic control has detected a fault condition. Push CLEAR pad to clear the display and stop the display from beeping. Reprogram the oven. If a fault reoccurs, record the fault number, push the CLEAR pad and contact an authorized servicer.
Faulty Installation	Place oven rack in center of oven. Place a level on the oven rack. Contact installing agent if rack and cabinet cutout flooring are not level. Kitchen cabinet misalignment may make oven appear to be not level. Be sure cabinets are square and level. Contact cabinet maker to correct problem.
Entire Oven Does Not Operate	When the oven is first plugged in, or when the power supply to the oven has been interrupted, the display will flash. The oven cannot be programmed until the clock is set. Be sure electrical cord is securely connected into the electrical junction box. Cord/plug is not installed and/or connected. Cord is not supplied with oven. Contact your dealer, installing agent or authorized servicer. Service wiring not complete. Contact your dealer, installing agent or authorized servicer. Power outage. Check house lights to be sure. Call your local electric company. Short in cord/plug. Replace cord/plug. Controls are not set properly. See instructions to set the controls. House fuse has blown or circuit breaker has tripped immediately following installation. House fuse may not be fully engaged. Check fuse and screw or engage circuit breaker securely.
Oven Light Does Not Work	Burned-out or loose bulb. Follow the instructions under Oven Light to replace or tighten the bulb.
Self-Cleaning Cycle Does Not Work	Make sure the oven door is closed. Controls not set properly. Follow instructions under "Using the Self-Clean Feature".
Oven Smokes Excessively During Broiling	Meat too close to the broiler element. Reposition the rack to provide more clearance between the meat and the broiler. Preheat broil element for quick searing operation. Meat not properly prepared. Remove excess fat from meat. Cut remaining fatty edges to prevent curling, but do not cut into the lean. Grid on broiler pan wrong side-up. Grease does not drain into broiler pan. Always place the grid on the broiler pan with the ribs up and the slots down to allow grease to drip into the pan. Broiler pan used without grid or grid cover with aluminum foil. DO NOT use the broiler pan without the grid or cover the grid with aluminum foil. Oven needs to be cleaned. Grease has built up on oven surfaces. Regular cleaning is necessary when broiling frequently. Grease or food spatters cause excessive smoking.
Soil Not Completely Removed After Self-Cleaning Cycle is Completed	Failure to clean bottom, from top of oven, frame of oven or door area outside oven seal. These areas are not in the self-cleaning area, but get hot enough to burn on residue. Clean these areas before the self-cleaning cycle is started. Burned on residue can be cleaned with a stiff nylon brush and water or a nylon scrubber. Be careful not to damage the oven gasket. Excessive spillovers in oven. Set the self-clean cycle for longer cleaning time.
Poor Baking Results	Many factors affect baking results. See Baking for hints, causes and corrections. See Adjusting Oven Temperature.
Flames Inside Oven or Smoke from Vent	Excessive spillovers in oven. This is normal, especially for high oven temperatures, pie spillovers or for large amounts of grease on bottom of oven. Wipe up excessive spillovers.

MAJOR APPLIANCE WARRANTY

Your appliance is covered by a one year limited warranty. For one year from your original date of purchase, Electrolux will pay all costs for repairing or replacing any parts of this appliance that prove to be defective in materials or workmanship when such appliance is installed, used and maintained in accordance with the provided instructions.

Exclusions **This warranty does not cover the following:**

- 1 Products with original serial numbers that have been removed, altered or cannot be readily determined.
- 2 Product that has been transferred from its original owner to another party or removed outside the USA or Canada.
- 3 Rust on the interior or exterior of the unit.
- 4 Products purchased "as-is" are not covered by this warranty.
- 5 Food loss due to any refrigerator or freezer failures.
- 6 Products used in a commercial setting.
- 7 Service calls which do not involve malfunction or defects in materials or workmanship, or for appliances not in ordinary household use or used other than in accordance with the provided instructions.
- 8 Service calls to correct the installation of your appliance or to instruct you how to use your appliance.
- 9 Expenses for making the appliance accessible for servicing, such as removal of trim, cupboards, shelves, etc., which are not a part of the appliance when it is shipped from the factory.
- 10 Service calls to repair or replace appliance light bulbs, air filters, water filters, other consumable, or knobs, handles, or other cosmetic parts.
- 11 Surcharges including, but not limited to, any after hour, weekend, or holiday service calls, tolls, ferry trip charges, or mileage expense for service calls to remote areas, including the state of Alaska.
- 12 Damages to the finish of appliance or home incurred during installation, including but not limited to floors, cabinets, walls, etc.
- 13 Damages caused by: services performed by unauthorized service companies; use of parts other than genuine Electrolux parts or parts obtained from persons other than authorized service companies; or external causes such as abuse, misuse, inadequate power supply, accidents, fires, or acts of God.

DISCLAIMER OF IMPLIED WARRANTIES; LIMITATION OF REMEDIES

Customer's sole and exclusive remedy under this limited warranty shall be product repair or replacement as provided herein. Claims based on implied warranties, including warranties of merchantability or fitness for particular purpose, are limited to one year or the shortest period allowed by law, but not less than one year. Electrolux shall not be liable for consequential or incidental damages such as property damage and incidental expenses resulting from any breach of this written limited warranty or any implied warranty. Some states and provinces do not allow the exclusion or limitation of incidental or consequential damages, or limitations on the duration of implied warranties, so these limitations or exclusions may not apply to you. This written warranty gives you specific legal rights. You may also have other rights that vary from state to state.

**If You
Need
Service**

Keep your receipt, delivery slip, or some other appropriate payment record to establish the warranty period should service be required. If service is performed, it is in your best interest to obtain and keep all receipts. Service under this warranty must be obtained contacting Electrolux at the addresses or phone numbers below.

This warranty only applies in the USA and Canada. In the USA, your appliance is warranted by Electrolux Major Appliances North America, a division of Electrolux Home Products, Inc. In Canada, your appliance is warranted by Electrolux Canada Corp. Electrolux authorizes no person to change or add to any obligations under this warranty. Obligations for service and parts under this warranty must be performed by Electrolux or an authorized service company. Product features or specifications as described or illustrated are subject to change without notice.

USA
1.800.944.9044
Electrolux Major Appliances
North America
P.O. Box 212378
Augusta, GA 30907



Canada
1.800.265.8352
Electrolux Canada Corp.
5855 Terry Fox Way
Mississauga, Ontario, Canada
L5V 3E4