

# SAMSUNG

## Product Guide

# 8751 Series Flex Duo™ Front Control Slide-In Electric Range

NE63T875ISS

NE63T875ISG

Available in: Fingerprint Resistant Stainless Steel,  
and Fingerprint Resistant Black Stainless Steel



# Table of Contents

## NE63T8751 - 6.3 cu. ft. Flex Duo™ Front Control Slide-in Electric Range with Smart Dial & Air Fry

### Product Overview

Product Overview 4

Carousel Image Order and Assets 5

### Product Messaging

Core Messaging 7

Features and Benefits 9

### Product Specs

Related Products and Accessories 15

Spec Sheet 16

User Manual 17

### Feature Icons

19

# Product Overview

---

**NE63T8751SS – 6.3 cu. ft. Flex Duo™ Front Control Slide-in Electric Range  
with Smart Dial & Air Fry**

# Product Overview

## Product Title

6.3 cu. ft. Flex Duo™ Front Control Slide-in Electric Range with Smart Dial & Air Fry

## Product Description

The new Samsung Flex Duo™ Front Control Slide-in Electric Range with Smart Dial and Air Fry is fully Wi-Fi connected and voice enabled, giving you the tools you need to simplify the cooking experience in the kitchen.

## Available Colors



**Fingerprint Resistant  
Stainless Steel**  
NE63T8751SS



**Fingerprint Resistant  
Black Stainless Steel**  
NE63T8751SG



# Carousel Image Order

Easy Ads links

Fingerprint Resistant Stainless Steel: <http://www.samsungeasyads.com/mm/nicePath/easyads?nav=pr658587578>  
Fingerprint Resistant Black Stainless Steel: <http://www.samsungeasyads.com/mm/nicePath/easyads?nav=pr658587618>

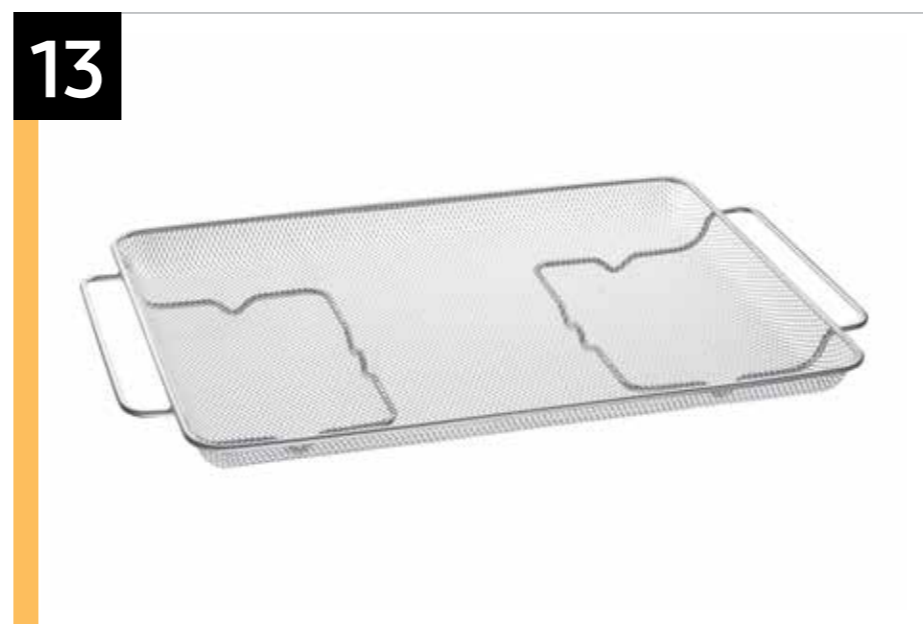

# Product Messaging

---

**NE63T8751SS – 6.3 cu. ft. Flex Duo™ Front Control Slide-in Electric Range  
with Smart Dial & Air Fry**

# Core Messaging

Priority	Feature	Feature Headline	Short Copy	Long Copy	
Signature	1	<b>Smart Dial</b>	Learns How You Like to Cook	The new Smart Dial simplifies oven settings in a single dial and learns cooking preferences.	The new Smart Dial simplifies oven settings in a single dial and intuitively learns based on your cooking preferences.
	2	<b>Air Fry</b>	Air Fry - Healthier* Cooking with a Crunch <small>*As compared to deep frying.</small>	A healthier* way to prepare your favorite fried foods right in your oven, with little to no oil. <small>*As compared to deep frying.</small>	Cooking just got healthier* with new Air Fry mode. Using little to no oil, you can quickly prepare your favorite fried foods right in your oven. Air Fry tray included. <small>*As compared to deep frying.</small>
	3	<b>Flex Duo™</b>	Two Ovens or One, You Choose	Use the full oven or split it into two separate smaller ovens to suit your needs.	The Flex Duo™ range is for the ultimate multi-tasker who wants to be efficient in the kitchen. Use the full oven, or split it into two separate smaller ovens to suit your needs.
Secondary Features	4	<b>Convection</b>	Save Time with Convection	Cooks food fast and more evenly.	Powerful convection saves you time by cooking food fast and more evenly. Perfect for baking and roasting.
	5	<b>Illuminated Knobs</b>	Know It's On	Illuminated knobs let you know when your cooktop is on or off.	Blue illuminated knobs let you know when your cooktop is on or off.
	6	<b>Fingerprint Resistant Finish</b>	All Shine	Fingerprint resistant, beautiful finish.	Fingerprint resistant, for an everyday beautiful finish.
	7	<b>Express Boil™</b>	Unbelievably Fast	No element is more powerful* – rapidly go from high heat for boiling water and searing meat or turn down to a true simmer. <small>*Based upon wattage, when compared to 30" radiant electric ranges.</small>	With Samsung's 3600 W Express Boil™ – no element is more powerful.* Rapidly go from high heat for boiling water and searing meat or turn down to a true simmer – ideal for melting chocolate or making sauces. <small>*Based upon wattage, when compared to 30" radiant electric ranges.</small>
	8	<b>Flexible Cooktop</b>	Flexible in Every Way	The 5-element cooktop includes dual and triple ring elements, so you can cook with multiple sized pots and pans.	The 5-element cooktop includes dual and triple ring elements, so you can cook with multiple sized pots and pans.
	9	<b>Large Oven Capacity</b>	Cook Enough for the Whole Crew	This large 6.3 cu. ft. oven fits multiple meals at one time.	This large 6.3 cu. ft. oven fits multiple meals at one time, or it can easily accommodate big casserole dishes or roasting pans.
	10	<b>Wi-Fi Connectivity</b>	Cook Smart, Save Time	Preheat, monitor, and adjust cook time and temperature on your oven and monitor your cooktop, right from your smartphone through the SmartThings™ App.* <small>*Available on Android and iOS devices. A Wi-Fi connection and a Samsung account are required.</small>	Preheat, monitor, and adjust cook time and temperature on your oven and monitor your cooktop, right from your smartphone through the SmartThings™ App.* <small>*Available on Android and iOS devices. A Wi-Fi connection and a Samsung account are required.</small>
	11	<b>Voice-Enabled</b>	"Preheat the Oven to 350° Please"	Control your oven by voice by using your favorite voice assistant, whether it's Bixby, Alexa or Google.* <small>*A Wi-Fi connection and a Samsung account are required. Bixby is Samsung's brand of artificial intelligence (AI) / Internet of Things (IoT) voice assistant. Voice commands are available on Android and iOS devices.</small>	Control your oven by voice when you're busy doing other things by using your favorite virtual assistant, whether it's Bixby, Alexa or Google.* <small>*A Wi-Fi connection and a Samsung account are required. Bixby is Samsung's brand of artificial intelligence (AI) / Internet of Things (IoT) voice assistant. Voice commands are available on Android and iOS devices.</small>

## Core Messaging (continued)

Priority	Feature	Feature Headline	Short Copy	Long Copy	
Secondary Features cont.	12	Self & Steam Clean	Does The Hard Work For You	Get help from your oven with Self & Steam Clean. The self cleaning system deep cleans by heating to a high temperature to burn off grease and food residue. Steam clean in 20 minutes for easier cleaning jobs.	
	13	Ready2Fit™ Guarantee	—	—	
	14	Built-in Temperature Probe	Know When the Roast Is Ready	Check the internal temperature of meats on your oven or smartphone.* <small>*Available on Android and iOS devices. A Wi-Fi connection and a Samsung account are required.</small>	Know the internal temperature of meats with a built-in temperature probe you can check on your oven or with your smartphone.* <small>*Available on Android and iOS devices. A Wi-Fi connection and a Samsung account are required.</small>
	15	Gliding Rack	Glide with Ease	Use the gliding rack to easily & safely take food out of the oven.	Use the gliding rack to easily & safely take food out of the oven. Simply hold the handle of the rack to slide it in and out.



## Features and Benefits



Simply dial and select a mode to start cooking

### Smart Dial

The new Smart Dial simplifies oven settings in a single dial and intuitively learns based on your cooking preferences.

*Video and still asset available.*



Cooking just got healthier\* with new Air Fry mode

\*As compared to deep frying

### Air Fry

Cooking just got healthier\* with new Air Fry mode. Using little to no oil, you can quickly prepare your favorite fried foods right in your oven. Air Fry tray included.

\*As compared to deep frying.

*Video and still asset available.*



### Flex Duo™

The Flex Duo™ range is for the ultimate multi-tasker who wants to be efficient in the kitchen. Use the full oven, or split it into two separate smaller ovens to suit your needs.

### Easy Ads links

**Fingerprint Resistant Stainless Steel:** <http://www.samsungeasyads.com/mm/nicePath/easyads?nav=pr658587580>

## Features and Benefits (continued)



### Convection

Powerful convection saves you time by cooking food fast and more evenly. Perfect for baking and roasting.



### Illuminated Knobs

Blue illuminated knobs let you know when your cooktop is on or off.



### Fingerprint Resistant Finish

Fingerprint resistant, for an everyday beautiful finish.

*Ensure asset used is accurate to the correct model finish color.*

**Easy Ads links**  
**Fingerprint Resistant Stainless Steel:** <http://www.samsungeasyads.com/mm/nicePath/easyads?nav=pr658587580>

## Features and Benefits (continued)



### Flexible Cooktop

The 5-element cooktop includes dual and triple ring elements, so you can cook with multiple sized pots and pans.



### Express Boil™

With Samsung's 3600 W Express Boil™ – no element is more powerful.\* Rapidly go from high heat for boiling water and searing meat or turn down to a true simmer – ideal for melting chocolate or making sauces.

\*Based upon wattage, when compared to 30" radiant electric ranges.



### Large Oven Capacity

This large 6.3 cu. ft. oven fits multiple meals at one time, or it can easily accommodate big casserole dishes or roasting pans.

**Easy Ads links**

**Fingerprint Resistant Stainless Steel:** <http://www.samsungeasyads.com/mm/nicePath/easyads?nav=pr658587580>

## Features and Benefits (continued)



### Wi-Fi Connectivity

Preheat, monitor and adjust cook time and temperature of your oven, right from your smartphone through the SmartThings™ App.\*

\*Available on Android and iOS devices. A Wi-Fi connection and a Samsung account are required.



### Voice-Enabled

Control your oven by voice when you're busy doing other things by using your favorite virtual assistant, whether it's Bixby, Alexa or Google.\*

\*A Wi-Fi connection and a Samsung account are required. Bixby is Samsung's brand of artificial intelligence (AI) / Internet of Things (IoT) voice assistant. Voice commands are available on Android and iOS devices.



### Self & Steam Clean

Get help from your oven with Self & Steam Clean. The self cleaning system deep cleans by heating to a high temperature to burn off grease and food residue. Steam clean in 20 minutes for easier cleaning jobs.

*Video and still asset available.*

### Easy Ads links

**Fingerprint Resistant Stainless Steel:** <http://www.samsungeasyads.com/mm/nicePath/easyads?nav=pr658587580>

## Features and Benefits (continued)



### Ready2Fit™ Guarantee

If your Samsung Front Control Slide-In Range doesn't fit your 30" Freestanding Range cutout, enjoy \$100\* on us to cover any countertop modification costs.

\*Visit [samsungpromotions.com/SlideInReady2Fit](http://samsungpromotions.com/SlideInReady2Fit) for details.

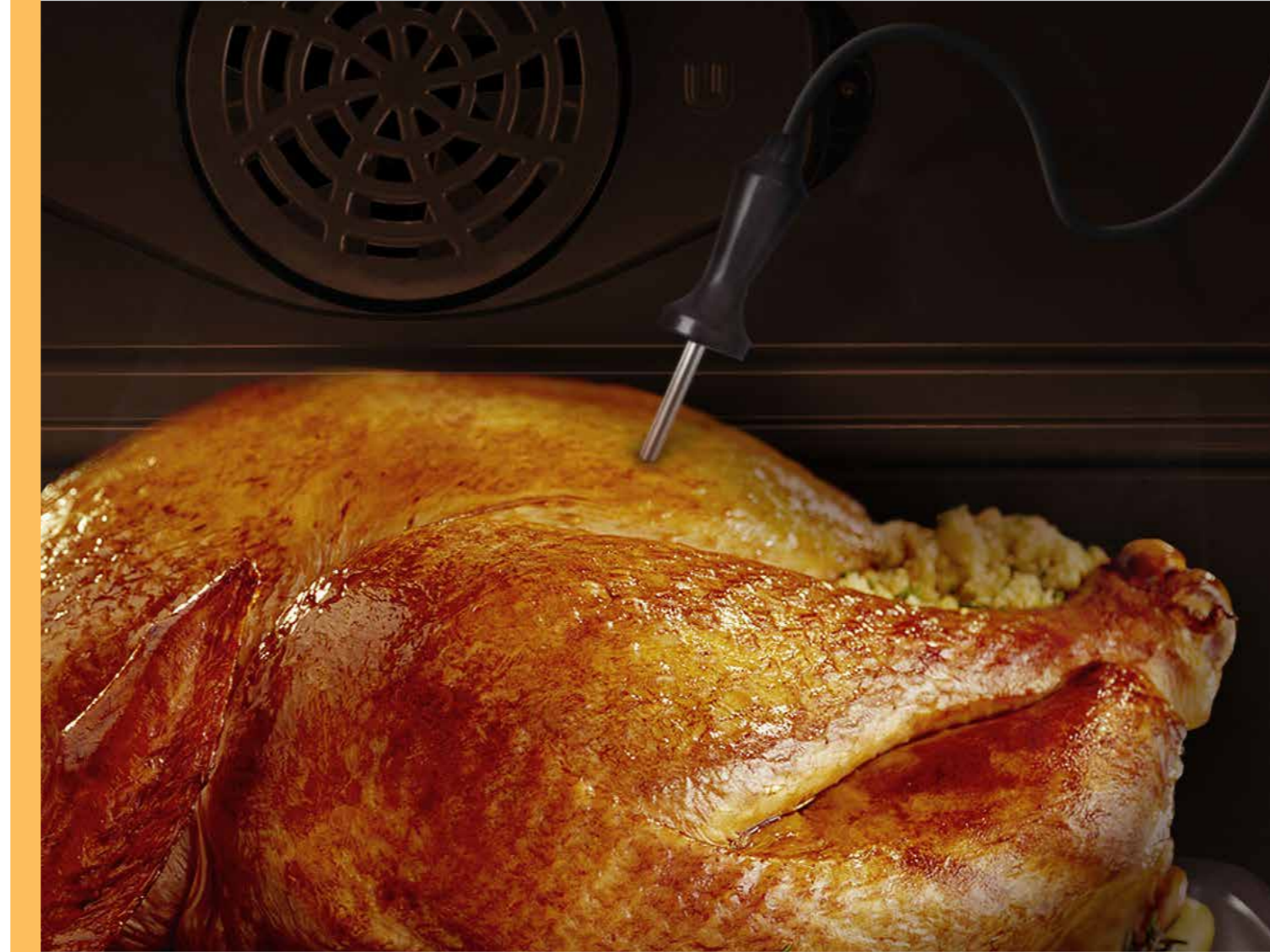

### Built-In Temperature Probe

Know the internal temperature of meats with a built-in temperature probe you can check on your oven or with your smartphone.\*

\*Available on Android and iOS devices. A Wi-Fi connection and a Samsung account are required.



### Gliding Rack

Use the gliding rack to easily & safely take food out of the oven. Simply hold the handle of the rack to slide it in and out.

### Easy Ads links

**Fingerprint Resistant Stainless Steel:** <http://www.samsungeasyads.com/mm/nicePath/easyads?nav=pr658587580>

# Product Specs

---

**NE63T8751SS – 6.3 cu. ft. Flex Duo™ Front Control Slide-in Electric Range  
with Smart Dial & Air Fry**

## Related Products

SKU	Type	Color(s)
<b>NE63T8751SS/AA</b>	Range Hood	NK30K7000WS/A2
	Over-The-Range Microwave	ME21M706BAS/AA
	Dishwasher	DW80R9950US/AA
	Refrigerator	RF22R7551SR/AA
<b>NE63T8751SG/AA</b>	Range Hood	NK30K7000WG/A2
	Over-The-Range Microwave	ME21M706BAG/AA
	Dishwasher	DW80R9950UG/AA
	Refrigerator	RF22R7551SG/AA

## Accessories

SKU	Description	Color(s)
NX-AB5900RS/AA	9" backguard for 30" slide-in range	Stainless Steel
NX-AB5400RS/AA	4" backguard for 30" slide-in range	
NX-AF5000RS/AA	Trim kit for 30" slide-in range, 5 piece	
NX-AB5900RB/AA	9" backguard for 30" slide-in range	Black (pairs with Black Stainless Steel)
NX-AB5400RB/AA	4" backguard for 30" slide-in range	
NX-AF5000RM/AA	Trim kit for 30" slide-in range, 5 piece	Black Stainless Steel (pairs with Black Stainless Steel)

# Spec Sheet

## Easy Ads link

<http://www.samsungeasyads.com/mm/nicePath/easyads?nav=pr658587449>

## NE63T8751SS

Samsung Flex Duo™ Front Control Slide-in Electric Range with Smart Dial & Air Fry

6.3 cu. ft. Capacity



**Signature Features**

**Smart Dial**

- The new Smart Dial simplifies oven settings in a single dial and intuitively learns based on your cooking preferences.

**Air Fry**

- Cooking just got healthier with new Air Fry mode\* Using little to no oil, you can quickly prepare your favorite fried foods right in your oven. Air Fry tray included.

\*As compared to deep frying.

**Flex Duo™**

- The Flex Duo™ range is for the ultimate multi-tasker who wants to be efficient in the kitchen. Use the full oven, or split into two separate smaller ovens to suit your needs.

**SAMSUNG**

**Available Colors**

- Fingerprint Resistant Stainless Steel (shown)
- Fingerprint Resistant Black Stainless Steel



Smart Dial



Air Fry

**Features**

- Smart Dial
- Air Fry, Tray Included
- Flex Duo™
- Convection
- Illuminated Knobs
- Fingerprint Resistant Finish
- 3600 W Express Boil™
- Large Oven Capacity – 6.3 cu. ft.
- Ready2Fit™ Guarantee
- Temperature Probe
- Gliding Rack
- Soft Close Door
- Storage Drawer

**Convenience**

- Wi-Fi Connectivity
- Voice-Enabled
- Convection Auto Conversion
- Self & Steam Clean
- Hidden Bake Element
- Child Safety Lock
- Delay Start
- Auto Oven Light
- Kitchen Timer
- Sabbath Mode

## NE63T8751SS

Samsung Flex Duo™ Front Control Slide-in Electric Range with Smart Dial & Air Fry

6.3 cu. ft. Capacity

**Installation Specifications**

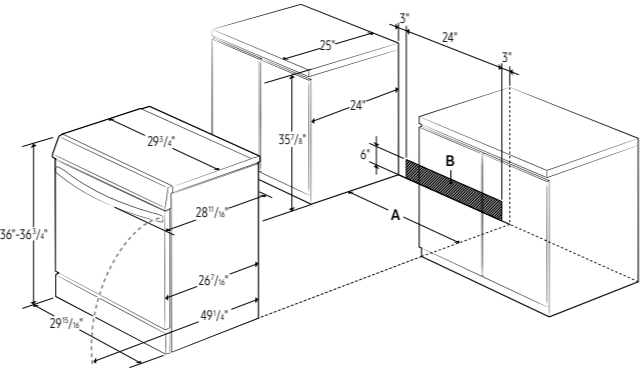

A: Cabinet opening min 30"  
B: Acceptable electrical outlet area

**IMPORTANT:** If your cabinets are over 36 1/4" high, you must install this range on a hard, heat-resistant support that raises the surface of the range so that it is about even with the countertop.

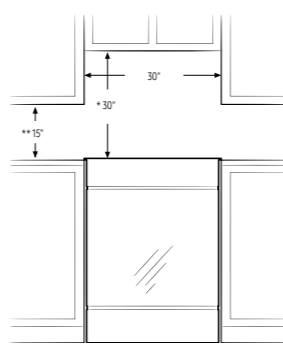

\*30" minimum clearance between the top of the cooking surface and the bottom of an unprotected wood or metal cabinet; or 24" minimum when the bottom of the wood or metal cabinet is protected by not less than 1/4" of flame retardant millboard covered with not less than no.28 MSG sheet steel, 0.015" stainless steel, 0.024" aluminum, or 0.020" copper.

\*\*15" minimum between the countertop and the adjacent cabinet bottom.

**IMPORTANT:** Consult with Installation Manual for detailed instructions before installing. All ranges must be installed with the Anti-Tip device that is included.

**SAMSUNG**

**Power Source**  
240V/208V/60 Hz/40A

**Electric Ceramic Cooktop**

- Right Front: 6"/9"/12" Triple Element, 3000 W
- Left Front: 6"/9" Dual Element, Express Boil™ 3600 W
- Right Rear: 6", 1200 W
- Left Rear: 6", 1200 W
- Center: 7", Warming Center

**Dual Oven**

- Upper Capacity: 3.4 cu. ft.
- Lower Capacity: 2.7 cu. ft.
- Convection Element/Heater
- Convection Bake
- Convection Roast
- Bake
- Variable Broil: Low/High
- Air Fry
- Bread Proof
- Dehydrate

**Warranty**  
One (1) Year Parts and Labor

**Product Dimensions & Weight (WxHxD)**  
Oven Interior Dimensions: 24 13/16" x 22 7/16" x 19 3/4"  
Outside Net Dimensions: 29 35/16" x 36 - 36 3/4" (Adjustable) x 28 11/16"  
Weight: 203 lbs

**Shipping Dimensions & Weight (WxHxD)**  
Dimensions: 33 1/16" x 41 1/4" x 30 3/16"  
Weight: 226 lbs

Color	Model #	UPC Code
Fingerprint Resistant Stainless Steel	NE63T8751SS	887276409115
Fingerprint Resistant Black Stainless Steel	NE63T8751SG	887276409108

Actual color may vary. Design, specifications, and color availability are subject to change without notice. Non-metric weights and measurements are approximate.  
©2020 Samsung Electronics America, Inc. 85 Challenger Road, Ridgefield Park, NJ 07660. Tel: 800-SAMSUNG. samsung.com. Samsung is a registered trademark of Samsung Electronics Co. Ltd.

Spec Sheet - front

Spec Sheet - back



# User Manual

## Easy Ads link

<http://www.samsungeasyads.com/mm/nicePath/easyads?nav=pr658587449>



User Manual

# Feature Icons

---

**NE63T8751SS – 6.3 cu. ft. Flex Duo™ Front Control Slide-in Electric Range  
with Smart Dial & Air Fry**

# Feature Icons

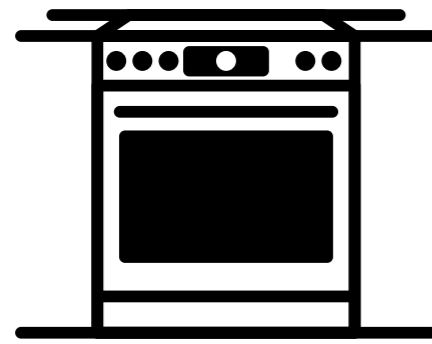

Slide-In Design

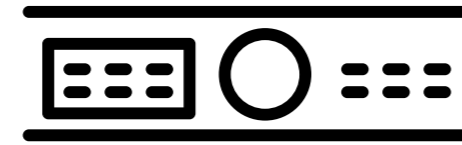

Smart Dial



Air Fry

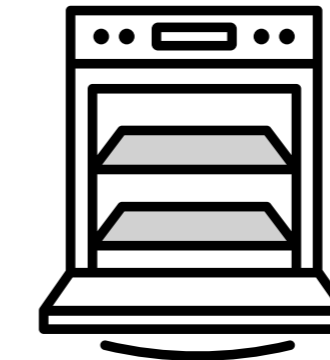

Flex Duo™

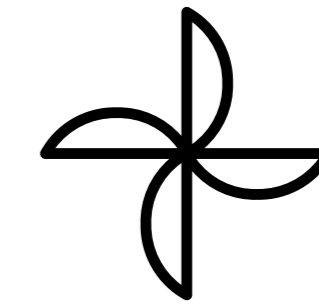

Convection

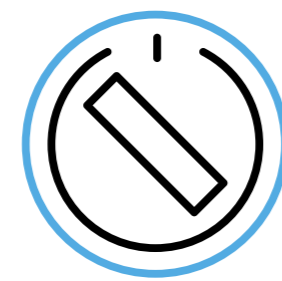

Illuminated Knobs



Fingerprint Resistant Finish

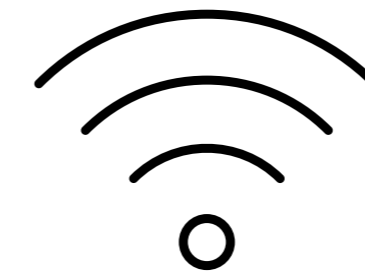

Wi-Fi Connectivity

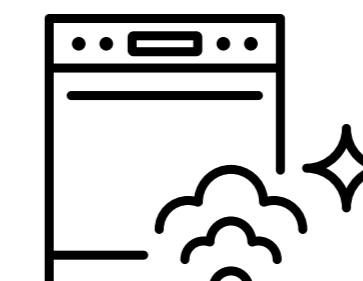

Self + Steam Clean

**SAMSUNG**