



# Washer

---

## User manual

WA50R5400A\*/WA50T5300A\*

---

**SAMSUNG**

# Contents

---

<b>Safety information</b>	<b>4</b>
What you need to know about the safety instructions	4
Important safety symbols	4
Important safety precautions	5
CALIFORNIA PROPOSITION 65 WARNING	6
Critical installation warnings	6
Installation cautions	7
Critical usage warnings	8
Usage cautions	9
Critical cleaning warnings	12
<b>Installation</b>	<b>13</b>
Unpacking your washer	13
What's included	14
Installation requirements	16
Step-by-step installation	19
<b>Before you start</b>	<b>25</b>
Initial settings	25
Laundry guidelines	25
Detergent drawer guidelines	29
<b>Operations</b>	<b>32</b>
Control panel	32
Simple steps to start	35
Cycle overview	36
Cycle chart	38
Special features	40
Smart Care	43

---

<b>Maintenance</b>	<b>44</b>
Self Clean	44
Cleaning the exterior	45
Cleaning the interior	45
Care for an extended period of non-use	45
Cleaning the mesh filter	46
Cleaning the detergent drawer	47
<b>Troubleshooting</b>	<b>49</b>
Checkpoints	49
Information codes	54
<b>Specifications</b>	<b>58</b>
Fabric care chart	58
Helping the environment	59
Declaration of conformity	60
Specification sheet	60

# Safety information

---

Congratulations on your new Samsung washer. This manual contains important information on the installation, use, and care of your appliance. Please take some time to read this manual to take full advantage of your washer's many benefits and features.

## What you need to know about the safety instructions

---

Please read this manual thoroughly to ensure that you know how to safely and efficiently operate the extensive features and functions of your new appliance. Please store the manual in a safe location close to the appliance for future reference. Use this appliance only for its intended purpose as described in this instruction manual.

Warnings and Important Safety Instructions in this manual do not cover all possible conditions and situations that may occur. It is your responsibility to use common sense, caution, and care when installing, maintaining, and operating your washer.

Because the following operating instructions cover various models, the characteristics of your washer may differ slightly from those described in this manual and not all warning signs may be applicable. If you have any questions or concerns, contact your nearest service center or find help and information online at [www.samsung.com](http://www.samsung.com).

## Important safety symbols

---

What the icons and signs in this user manual mean:

 **WARNING**

Hazards or unsafe practices that may result in **severe personal injury, death, and/or property damage**.

 **CAUTION**

Hazards or unsafe practices that may result in **personal injury and/or property damage**.

 **NOTE**

Indicates that a risk of personal injury or material damage exists.

These warning signs are here to prevent injury to yourself and others. Please follow them explicitly. After reading this manual, store it in a safe place for future reference.

Read all instructions before using the appliance.

As with any equipment that uses electricity and moving parts, potential hazards exist. To safely operate this appliance, familiarize yourself with its operation and exercise care when using it.

# SAVE THESE INSTRUCTIONS



---

## Important safety precautions

---

### **WARNING**

To reduce the risk of fire, electric shock, or injury to persons when using your appliance, follow basic precautions, including the following:

1. Read all instructions before using this appliance.
2. Do not wash or dry articles that have been previously cleaned in, washed in, soaked in, or spotted with gasoline, dry-cleaning solvents, other flammable or explosive substances as they give off vapors that could ignite or explode.
3. Do not allow children to play on or in the appliance. Close supervision of children is necessary when the appliance is used near children.
4. Before the appliance is removed from service or discarded, remove the lid of the washing or drying compartment.
5. Do not reach into the appliance if the drum is moving.
6. Do not install or store this appliance where it will be exposed to the weather.
7. Do not tamper with the controls.
8. Do not repair or replace any part of the appliance or attempt any servicing unless it is specifically recommended in the user-maintenance instructions or in published user-repair instructions that you understand and have the skills to carry out.
9. Do not add gasoline, dry-cleaning solvents, or other flammable or explosive substances to the wash water. These substances give off vapors that could ignite or explode.
10. Under certain conditions, hydrogen gas may be produced in a hot water system that has not been used for 2 weeks or more. **HYDROGEN GAS IS EXPLOSIVE.** If the hot water system has not been used for 2 weeks or more, before using a washer or combination washer-dryer, turn on all hot water faucets and let the water flow from each for several minutes. This will release any accumulated hydrogen gas. As the gas is flammable, do not smoke or use an open flame during this time.

## SAVE THESE INSTRUCTIONS

# Safety information

---

## CALIFORNIA PROPOSITION 65 WARNING

---

### **WARNING**

Cancer and Reproductive Harm - [www.P65Warnings.ca.gov](http://www.P65Warnings.ca.gov).

## Critical installation warnings

---

### **WARNING**

Plug the power cord into an AC 120 V / 60 Hz/wall socket rated at 15 amps or higher. Use the socket for this appliance only. In addition, do not use an extension cord.

- Sharing a wall socket with other appliances, using a power strip, or extending the power cord may result in electric shock or fire.
- Do not use an electric transformer. It may result in electric shock or fire.
- Ensure that the power voltage, frequency, and current match the product's specifications. Failing to do so may result in electric shock or fire.

Have this appliance installed by a qualified technician or service company.

- Failing to do so may result in electric shock, fire, an explosion, problems with the product, or injury.

Remove all foreign substances such as dust or water from the power plug terminals and contact points using a dry cloth on a regular basis.

- Unplug the power plug and clean it with a dry cloth.
- Failing to do so may result in electric shock or fire.

Plug the power plug into the wall socket in the right direction so that the cord runs towards the floor.

- If you plug the power plug into the socket in the opposite direction, the electric wires within the cable may be damaged and this may result in electric shock or fire.

This appliance must be properly grounded. Do not ground the appliance to a gas pipe, plastic water pipe, or telephone line.

- Improper grounding may result in electric shock, fire, an explosion, or problems with the product.
- Never plug the power cord into a socket that is not grounded correctly. Make sure the socket you use is grounded in accordance with local and national codes.

Do not install this appliance near a heater or flammable material.

## SAVE THESE INSTRUCTIONS

---

Do not install this appliance in a humid, oily, or dusty location, or in a location exposed to direct sunlight or water (rain drops).

Do not install this appliance in a location where gas may leak.

- This may result in electric shock or fire.

Plug the power plug into the wall socket firmly. Do not use a damaged power plug, damaged power cord, or loose wall socket.

- This may result in electric shock or fire.

Do not pull or excessively bend the power cord.

Do not twist or tie the power cord.

Do not hook the power cord over a metal object, place a heavy object on the power cord, insert the power cord between objects, or push the power cord into the space behind the appliance.

- This may result in electric shock or fire.

Do not pull the power cord when unplugging the power plug.

- Unplug the power plug by pulling the plug.
- Failing to do so may result in electric shock or fire.

If the power plug or power cord are damaged, contact your nearest Samsung service center.

## Installation cautions

---

### CAUTION

Position the appliance so that the power plug is easily accessible.

- Failing to do so may result in electric shock or fire due to electric leakage.

Install your appliance on a level and hard floor that can support its weight.

- Failing to do so may result in abnormal vibrations, noise, or problems with the product.

Unplug the power plug when the appliance is not being used for long periods of time or during a thunder/lightning storm.

- Failing to do so may result in electric shock or fire.

# SAVE THESE INSTRUCTIONS

# Safety information

---

## Critical usage warnings

---

### **WARNING**

If the appliance is flooded, cut the power immediately and contact your nearest Samsung service center.

If the appliance emits a strange noise, a burning smell, or smoke, unplug the power plug immediately and contact your nearest Samsung service center.

- Failing to do so may result in electric shock or fire.

In the event of a gas leak (such as propane gas, LP gas, etc.), ventilate the area immediately. Do not turn any appliance or light on or off.

- Do not use a ventilating fan.
- A spark may result in an explosion or fire.

Do not wash items contaminated with gasoline, kerosene, benzene, paint thinner, alcohol, or other flammable or explosive substances.

- This may result in electric shock, fire, or an explosion.

Do not force the washer lid open while the washer is operating (high-temperature washing/drying/spinning).

- Water flowing out of the washer may cause burns or cause the floor to be slippery. This may result in injury.
- Forcing the lid open can damage the product or cause injury.

Make sure to remove the packaging (sponge, styrofoam) attached to the bottom of the washer before using it.

Do not insert your hand under the washer.

- This may result in injury.

Do not touch the power plug with wet hands.

- This may result in electric shock.

Do not turn the appliance off by unplugging the power plug while the washer is in operation.

- Plugging the power plug into the wall socket again may cause a spark and result in electric shock or fire.

Keep all packaging materials well out of the reach of children, as packaging materials can be dangerous to children.

- If a child places a plastic bag over his or her head, the child may suffocate.

## **SAVE THESE INSTRUCTIONS**

---

Do not insert your hand or a metal object under the washer while it is operating.

- This may result in injury.

Do not attempt to repair, disassemble, or modify the appliance yourself.

- Do not use any fuse (such as copper, steel wire, etc.) other than a standard fuse.
- If you need to repair or reinstall the appliance, contact your nearest Samsung service center.
- Failing to do so may result in electric shock, fire, problems with the product, or injury.

If any foreign substance such as water enters the appliance in any area other than the tub, unplug the power plug and contact your nearest Samsung service center.

- Failing to do so may result in electric shock or fire.

If the water supply hose comes loose from the faucet and floods the appliance, unplug the power plug.

- Failing to do so may result in electric shock or fire.

For waterproof fabrics, only use the WATERPROOF cycle.

- Do not use other cycles for waterproof fabrics. This may result in injury or damage to the washer, walls, floor, or clothing due to abnormal vibrations.
- Set the temperature and spin according to the attached care label.
- **WARNING** : Failure to closely follow these instructions may result in an abnormal vibrating and out-of-balance condition that could result in physical injury, property damage, and/or appliance damage.

Remove your hands from the top of the washing machine before closing the lid.

- This will prevent any hand injury that may occur when closing the lid.

## Usage cautions

---

### CAUTION

If the washer is contaminated by a foreign substance such as detergent, dirt, food waste, etc., unplug the power plug and clean the washer using a damp, soft cloth.

- Failing to do so may result in discoloration, deformation, damage, or rust.

The clear portion of the lid can be broken by a strong impact. Take care when using the washer.

- If the clear portion is cracked or broken, it may result in injury.

# SAVE THESE INSTRUCTIONS

# Safety information

---

After a water supply failure or when reconnecting the water supply hose, open the faucet slowly.

Open the faucet slowly after a long period of non-use.

- The air pressure in the water supply hose or the water pipe may result in damage to a part or in water leakage.

If a drain error occurs during an operation, check if there is a draining problem.

- If the washer is used when it is flooded because of a draining problem, it may result in electric shock or fire due to electric leakage.

Do not insert your hand under the washer.

- This may result in injury.

Insert the laundry into the washer completely so that laundry does not get caught in the lid.

- If laundry gets caught in the lid, it may result in damage to the laundry or the washer, or result in water leakage.

Ensure that the faucet is turned off when the washer is not being used.

- Ensure that the water supply hose connectors are properly tightened.
- Failing to do so may result in property damage or injury.

Open the faucet and check if the water supply hose connector is firmly tightened and that there is no water leaking before using the product.

- If the water supply hose connectors are loose, it may result in water leakage.

Do not stand on top of the appliance or place objects (such as laundry, lighted candles, lighted cigarettes, dishes, chemicals, metal objects, etc.) on the appliance.

- This may result in electric shock, fire, problems with the product, or injury.

Do not operate the appliance with wet hands.

- This may result in electric shock.

Do not spray volatile material such as insecticide onto the surface of the appliance.

- As well as being harmful to humans, it may also result in electric shock, fire, or problems with the product.

Do not place an object that generates an electromagnetic field near the washer.

- This may result in injury due to a malfunction.

Since the water drained during a high-temperature wash or drying cycle is hot, do not touch the water.

## SAVE THESE INSTRUCTIONS

- 
- This may result in burns or injury.

Do not operate the washer if the detergent dispenser is removed.

- This may result in electric shock or injury due to water leakage.

Do not insert your hand into the detergent dispenser after opening it.

- This may result in injury as your hand may be caught.

Do not place any non-laundry objects, such as shoes, food waste, or animals into the washer.

- This can cause abnormal vibrations that can damage the washer, and, in the case of pets, cause severe injury or death.

Do not press the buttons using sharp objects such as pins, knives, fingernails, etc.

- This may result in electric shock or injury.

Do not wash laundry contaminated by oils, creams, or lotions usually found in skincare shops or massage clinics.

- This may result in the rubber seal becoming deformed and water leakage.

Do not leave metal objects (safety pins, hair pins, etc.) or bleach in the tub for long periods of time.

- This may cause the tub to rust.
- If rust appears on the surface of the tub, apply a neutral cleansing agent to the surface and use a sponge to clean it. Never use a metal brush.

Do not use dry cleaning detergent in the tub and do not wash, rinse, or spin laundry contaminated by dry cleaning detergent.

- This may result in spontaneous combustion or ignition due to heat from the oxidation of the oil.

Do not use hot water from water cooling/heating devices.

- This may result in problems with the washer.

Do not use natural hand-washing soap in the washer.

- If it hardens and accumulates inside the washer, it may cause problems with the product, discoloration, rust, or bad odors.

Do not wash large laundry items such as bedding in the washing net.

- Failing to do so may result in injury due to abnormal vibrations.
- Place smaller items, such as lace socks and lingerie in the washing net.

Do not use hardened detergent.

## SAVE THESE INSTRUCTIONS

# Safety information

---

- If it accumulates inside the washer, it may result in water leakage.

Do not wash throw rugs or doormats in the washer.

- If you wash throw rugs or doormats, the sand will accumulate inside the washer. It may result in error such as no draining.

## Critical cleaning warnings

---

### **WARNING**

Do not clean the appliance by spraying water directly onto it.

Do not use a strong acid cleaning agent.

Do not use benzene, paint thinner, or alcohol to clean the appliance.

- This may result in discoloration, deformation, damage, electric shock, or fire.

Before cleaning or performing maintenance, unplug the appliance from the wall socket.

- Failing to do so may result in electric shock or fire.

**SAVE THESE INSTRUCTIONS**



# Installation

Follow these instructions carefully to ensure proper installation of your washer and to prevent accidents when using it.

## **⚠ WARNING**

Certain internal parts are intentionally not grounded and may present a risk of electric shock only during servicing. Service personnel – Do not contact the following parts while the appliance is energized: Control board, heat sink, motor, inlet valve, heater and pump.

## Unpacking your washer

Unpack your washer and inspect it for shipping damage. Make sure you have received all the items shown on the next page. If your washer was damaged during shipping, or you do not have all of the items, call 1-800-726-7864 (1-800-SAMSUNG).

To prevent personal injury or strain, wear protective gloves whenever lifting or carrying the unit.

## **⚠ WARNING**

Packing materials can be dangerous to children; Keep all packing material (plastic bags, polystyrene, etc.) well out of children's reach.

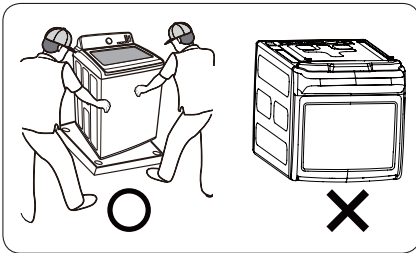

## **⚠ CAUTION**

You must have at least 2 people unpack the washer. To remove the cushion bottom of the packing materials, do not tip the washer over on its front side.

When you lay the washer down to remove the carton base, protect the side of the washer and lay it down carefully. Never lay your washer on its back or front.

# Installation

## What's included

Make sure all the parts are included in the product package. If you have a problem with the washer or the parts, contact the Samsung customer care center at 1-800-SAMSUNG (1-800-726-7864) or your retailer.

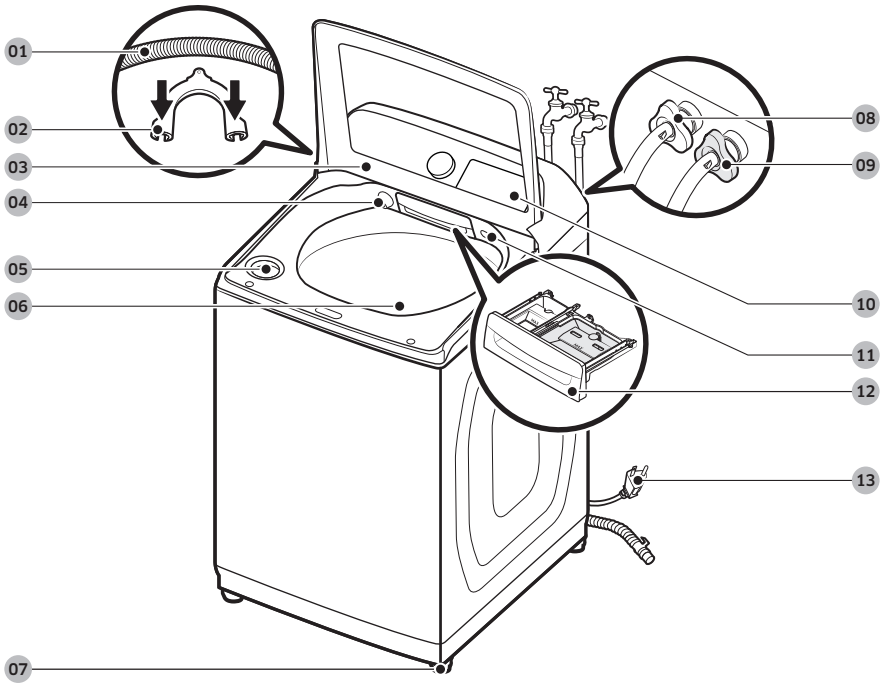

**01** Drain hose

**02** Hose guide

**03** Lid

**04** Active Waterjet nozzle

**05** Bleach compartment

**06** Tub

**07** Leveling feet

**08** Water hose (Hot)

**09** Water hose (Cold)

**10** Control panel

**11** Active Waterjet button

**12** Detergent drawer

**13** Power cord

## Parts supplied



Hose guide



User manual



Cable tie



Water intake cap

## Parts not supplied

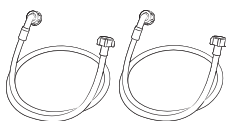

Water hoses

## Tools needed for installation



Wrench



Phillips  
screwdriver



Level



Adjustable  
pliers

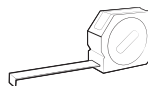

Measuring tape

### NOTE

- If you lose an accessory and want to purchase a replacement, contact the Samsung customer care center at 1-800-SAMSUNG (1-800-726-7864).
- The design of the parts and accessories may differ from the pictures above. Their design is subject to change without notice for product improvement.

### CAUTION

- Do not reuse old water hoses, which may leak or burst, causing flooding and/or property damage.
- Make sure rubber washers are inserted in each coupling of both water hoses.

# Installation

---

## Installation requirements

---

### Electrical supply and grounding

- AC 120 V / 60 Hz / 15 AMP fuse or circuit breaker is required.
- Use an individual branch circuit. Connect only the washer to the circuit.

To ensure proper grounding, the washer comes with a power cord featuring a three-prong grounding plug for use in a properly installed and grounded outlet.

Check with a qualified electrician or service person if you are not sure about the grounding.

Do not modify the provided plug. If it does not fit the outlet, call a qualified electrician to install a proper outlet.

#### **WARNING**

- Do NOT use an extension cord.
- Use only the power cord that comes with the washer.
- Do NOT connect the ground wire to plastic plumbing, gas lines, or hot water pipes.
- Improperly connected grounding conductors may cause electric shock.
- To prevent unnecessary risk of fire, electrical shock, or personal injury, all wiring and grounding must be done in accordance with local codes, or in the absence of local codes, in accordance with the National Electrical Code, ANSI/NFPA No. 70-Latest Revision (for the U.S.) or the Canadian Electrical Code CSA C22.1 - Latest Revisions and local codes and ordinances. It is your responsibility to provide adequate electrical service for your washer.

### Water supply

Proper water pressure for this washer is between 20-116 psi (137-800 kPa). Water pressure less than 20 psi (137 kPa) may cause the water valve not to close completely. or it may take longer to fill the drum, causing the washer to turn off. Water taps must be within 4 ft. (122 cm) from the rear of the washer so that the provided inlet hoses reach the washer.

To reduce the risk of leaks:

- Make sure water taps are easily accessible.
- Turn off the taps when the washer is not in use.
- Check for any leaks at the water inlet hose fittings on a regular basis.

#### **CAUTION**

Before using the washer for the first time, check all connections at the water valve and taps for any leaks.

## Drain

Samsung recommends a standpipe 39 in. (990 mm) high. The drain hose must be connected through the hose clip to the standpipe, and the standpipe must fully cover the drain hose.

## Flooring

For best performance, the washer must be installed on a solid floor. Wood floors may need to be reinforced to minimize vibration and/or unbalanced loads. Carpeting and soft tile surfaces do not provide good resistance to vibrations and may cause the washer to move slightly during the spin cycle.

### CAUTION

Do NOT install the washer on a platform or a poorly supported structure.

## Water temperature

Do not install the washer in areas where water may freeze as the washer always retains some water in its water valves, pumps, and/or hoses. Frozen water can cause damage to belts, the pump, and other components of the washer.

## Dimensions

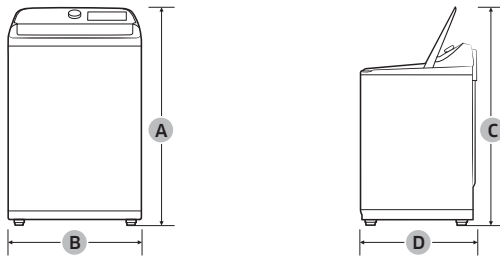

A. Height	44.6 in. (1132 mm)
B. Width	27.5 in. (699 mm)
C. Height with lid open	58.3 in. (1480 mm)
D. Depth	29.4 in. (747 mm)

# Installation

## Clearance requirement

This clearance requirement is applicable for washers only.

### NOTE

- For the dryer's clearance requirement, see the dryer's user manual.
- If the washer and dryer have different clearance requirements, use the one with the larger value.

## Alcove or closet installations

Minimum clearance for stable operation:

Sides	Top	Rear	Front
1 in. / 25 mm	21 in. / 533 mm	5.9 in. / 150 mm	1 in. / 25 mm

If both the washer and a dryer are installed in the same location, the front of the alcove or closet must have two unobstructed air openings for a combined minimum total area of 72 in.<sup>2</sup> (465 cm<sup>2</sup>).

This clearance requirement is applicable for washer and dryer pair installation.

### Side by side installation

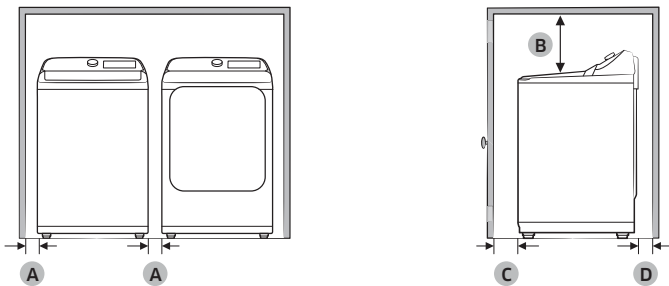

A	1 in. (25 mm)
B	21 in. (533 mm)
C	1 in. (25 mm)
D	5.9 in. (150 mm)

---

## Step-by-step installation

---

### STEP 1 Select a location

---

Location requirements:

- A solid, level surface without carpeting or flooring that may obstruct ventilation
- No direct sunlight
- Adequate room for ventilation and wiring
- Ambient temperature always higher than the freezing point (32 °F / 0 °C)
- Away from heat sources

### STEP 2 Connect the water hose

---

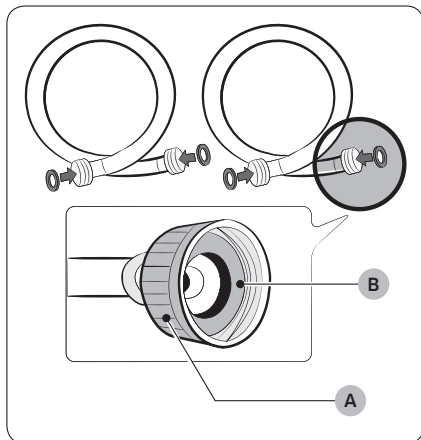

#### **CAUTION**

- Make sure to use new water hoses and that **rubber gaskets (B)** are inside the **couplings (A)** at both ends of the hoses. Water hoses without the gaskets may leak.
- Allow 6 in. (150 mm) of space between the back of the washer and the wall to prevent water hoses from being kinked. Kinked hoses may cause water leaks.
- If there is a water leak, stop using the washer and contact a local Samsung service center. A water leak may cause electric shock.
- Do not stretch the water hoses by force. If a hose is too short, replace the hose with a longer hose.

# Installation

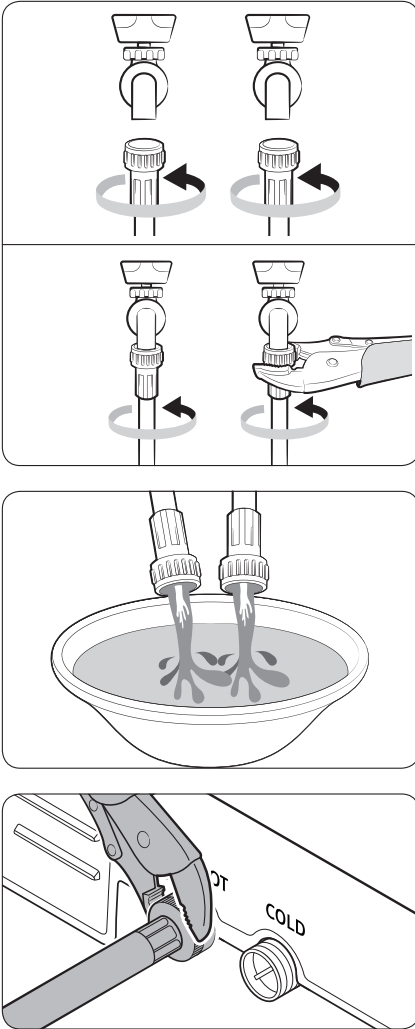

1. Attach the water hoses to the hot and cold water taps, and then hand tighten the water hose fittings until they are tight. Then, use pliers to tighten the fittings by an additional two-thirds of a turn. To avoid damaging the fittings, do not overtighten them.
2. Pull the water hoses to check if they are firmly connected.

3. Put the other ends of the hoses into a bucket, and then open the water taps for 10 - 15 seconds to remove impurities. When done, close the taps.

4. Attach the water hoses to the hot and cold water inlets on the back of the washer, and then hand tighten the water hose fittings until they are tight. Then, use pliers to tighten the fittings by an additional two-thirds of a turn.

## NOTE

If you do not want to use the hot water supply hose, insert the water intake cap onto the hot water supply intake. When you do a wash, press **Temp.** to select Cold.



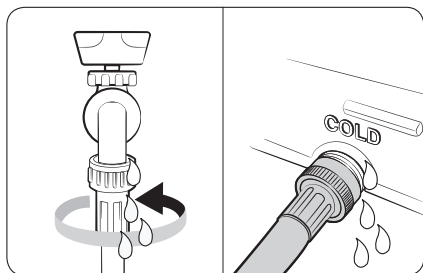

- Open the water taps, and check for leaks.

### STEP 3 Connect the drain hose

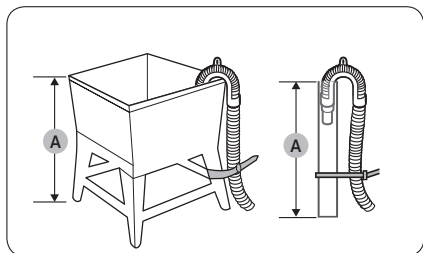

#### To a Laundry Tub or Drain Pipe

- Check the **height (A)** of your drain system and make sure the minimum and maximum heights shown below are met.

Minimum	39 in. (99 cm)
Maximum	96 in. (245 cm)

#### NOTE

- Make sure to measure the height from the floor where the washer is placed.
  - Draining efficiency may be reduced if the drain system is at the maximum height.
  - To prevent the washer from siphoning water, do not use a drain system below the minimum height.
- Attach the drain hose to the **plastic hose guide (B)**.

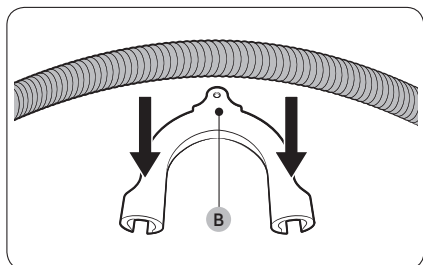

# Installation

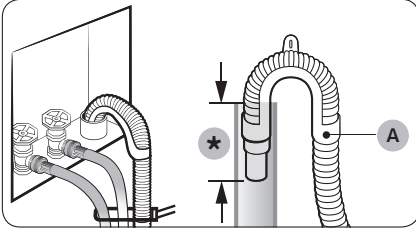

(\*): Min. 6 in. (152 mm), Max. 8 in. (203 mm)

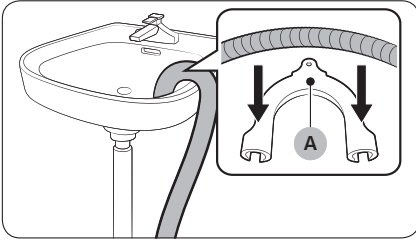

3. Route the drain hose to the drain system.

## ⚠ CAUTION

- If using a standpipe, make sure the standpipe and drain hose connection is not airtight.
  - If using a standpipe, make sure the drain hose is inserted at least 6 in. (152 mm) but no more than 8 in. (203 mm) into the standpipe.
4. Secure the drain hose with cable ties.

## Over the edge of a wash basin

The drain hose must be placed no lower than 24 in. (60 cm) and no higher than 35 in. (90 cm) from the floor. To keep the spout of the drain hose bent, use the supplied plastic **hose guide (A)**. Secure the guide to the wall using a hook to ensure stable drainage.

## STEP 4 Level the washer

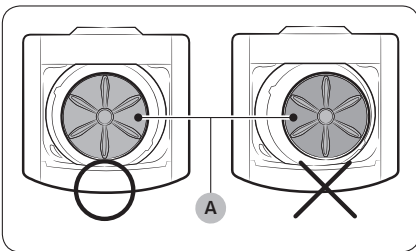

1. Slide the washer into position.
2. Open the lid of the washer, and then pour the water into the tub until the blades of the pulsator on the bottom of the washer are about half covered.
3. If the washer is level, the **pulsator (A)** will be positioned at the center of the tub as shown in the figure and the water will appear level in the tub. That is, the water will reach the same height on all sides of the tub.

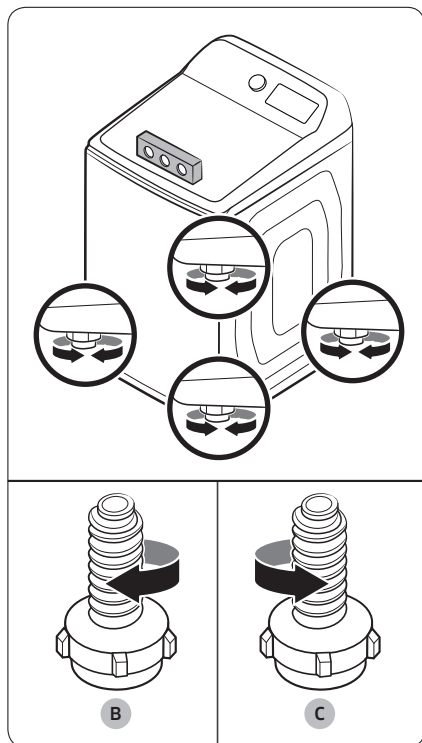

4. If the washer is not level, turn the appropriate leveling foot **clockwise (B)** to lower the washer, or **counterclockwise (C)** to raise the washer so that it is level.
5. Once you have the washer leveled, push down on all 4 corners to ensure that all 4 feet are touching the floor. If the washer rocks when you push down on a corner, adjust the leveling foot at that corner so the foot is firmly on the floor.

 **NOTE**

- You can also level the washer by lining a level up with the seam that runs between the top of the washer and the body of the washer and checking if the washer is level on all 4 sides.
- See the diagram above, left. After you have checked all 4 sides and leveled the washer, perform Step 5 above.

# Installation

---

## STEP 5 Power on

---

Plug the power cord into an AC 120 V / 60 Hz / 15 AMP approved electrical outlet protected by a 15-amp fuse or circuit breaker. Then, press **Power** to turn on the washer.

## STEP 6 Run a test cycle

---

Run a test cycle as follows to check if your washer is properly installed.

1. Load about 6 lb. of laundry into the tub.
2. Press **Power** to turn on your washer.
3. Turn the **Cycle Selector** to **RINSE+SPIN**.
4. Press and hold **Start/Pause (Hold to Start)** to start the test cycle.
5. The washer should not rock or vibrate excessively when water is supplied or when washing and spinning, and should drain well during the spin cycle.

### **NOTE**

- If water leaks while water is being supplied or drained, check the water connections. See “**Connect the water hose**” on page 19.
- If the washer rocks and vibrates excessively, level your washer again. See “**Level the washer**” on page 22.

# Before you start

---

## Initial settings

---

### Run calibration (recommended)

Calibration ensures accurate weight detection by the washer. Make sure the tub is empty before running calibration.

1. Press **Power** to turn on the washer.
2. Press and hold **Temp.** and **Delay End** simultaneously for 3 seconds.
3. Press and hold **Start/Pause (Hold to Start)** to start calibration.
  - The tub rotates clockwise or counterclockwise for approximately 2 minutes.
4. When complete, "0" appears on the display, and the washer turns off automatically.

## Laundry guidelines

---

### STEP 1 Sort

---

Sort the laundry according to these criteria:

- Care label: sort the laundry into cottons, mixed fibers, synthetics, silks, wools, and rayon.
- Color: Separate whites from colors.
- Size: Mixing different sized items together in the tub improves washing performance.
- Sensitivity: Wash delicate items separately. For pure new woolen items, curtains, and silk items, check the labels on the items.

#### NOTE

Make sure to check the care label on all clothing, and sort clothing accordingly before starting the wash.

### STEP 2 Empty pockets

---

Empty all the pockets of your laundry items

- Metal objects such as coins, pins, and buckles on clothing may damage other laundry items as well as the tub.

Turn clothing with buttons and embroideries inside out

- If pants or jacket zippers are open while washing, the tub may be damaged. Zippers should be closed and fixed with a string.
- Clothing with long strings may become entangled with other clothes. Make sure to tie the strings before starting the wash.

# Before you start

## STEP 3 Use a laundry net

- Brassieres (water washable) must be placed in a laundry net. Metal parts of the brassieres may break through and tear other laundry items.
- Cashmilon, large volume items, and lightweight clothes (lace-decorated clothes, lingerie, nylon stockings, and synthetic fabrics) may float during washing and not wash properly. Use the laundry net or wash them separately.
- Do not wash the laundry net by itself without other laundry. This can cause abnormal vibrations that could cause the washer to move and result in injury.

### CAUTION

Make sure to soak inflatable items (such as blankets, and cotton-filled or microfiber quilts) in water before you run a cycle.

- Inflatable items may damage the laundry or the washer during the washing or spinning process.
- Regardless of the size, it is safer to wash blankets or quilts one item at a time. This will also get them cleaner. Two different-sized blankets in the same load can cause the load to become unbalanced, compromising the spinning process.

### To put a blanket in your washer

Fold the blanket as shown, and then put it below the **plastic ring (A)** at the top of the tub.

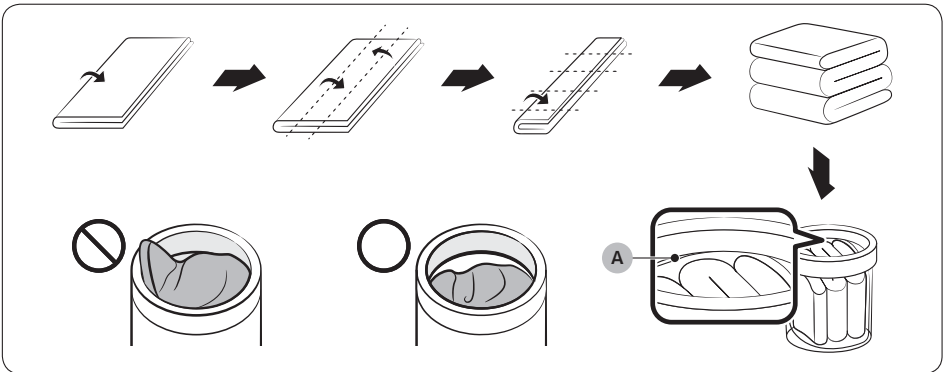

---

**NOTE**

Do not wash different types of bedding (blankets, sheets, comforters/duvets) together. They can get unbalanced in the tub and cause poor spinning results.

- Separate the beddings by their type before washing.
  - If an item is bulky and absorbs large amounts of water during washing, wash that item individually.
  - Do not wash light items with items that hardly absorb water together.
  - Do not wash duvets or comforters with their covers or bed sheets.

**STEP 4 Prewash (if necessary)**

---

- To remove stains and dirt on collars, sleeves, hems, and pockets, apply detergent lightly, let sit for a minute, and then brush off carefully.
- Use powder or liquid detergents. Do not use soap. Soap can remain on the tub after washing.
- To prewash white socks, sleeves, and collars apply a little detergent, and then brush carefully.

**CAUTION**

Make sure the laundry is inserted completely.

- Any exposed part of the laundry can cause damage to the washer or the laundry itself or cause a water leak.
- Make sure the laundry does not extend past the plastic ring at the top of the tub.

**STEP 5 Determine the load capacity**

---

Make sure the laundry does not extend past the plastic ring at the top of the tub. If it does, it can cause the washing machine to wash improperly or cause damage to the washer or the laundry itself or cause a water leak.

**NOTE**

When washing bedding or bedding covers, the wash time may be lengthened or the spin efficiency may be reduced.

For bedding or bedding covers, the recommended load capacity is 7.5 lb (3.5 kg) or less.

**CAUTION**

If the laundry is unbalanced and the “UB” information code is displayed, redistribute the load. Unbalanced laundry can reduce spinning performance.

# Before you start

---

## STEP 6 Add the correct detergent type

---

The type of detergent you use - general purpose, specifically for woolens, etc. - depends on the type of fabric (cotton, synthetic, delicate items, wool), color, wash temperature, and degree of soiling. Regardless of the specific type of detergent you use, always use "low suds" HE laundry detergent which is designed for automatic washers.

### NOTE

- Follow the detergent manufacturer's recommendations based on the weight of the laundry, the degree of soiling, and the hardness of the water in your local area. If you are not sure about the water hardness, contact your local water authority.
- Do not use detergent that tends to harden or solidify. This detergent may remain in the washer after the rinse cycle, blocking the drain outlet.

Use HE detergent only



Your washer is designed to use high efficiency (HE) detergents.

- For the best cleaning results, use a high efficiency detergent such as Tide HE, Wisk HE, Cheer HE or Gain HE\*. High efficiency detergents contain suds suppressors that reduce or eliminate suds. When fewer suds are produced, the load tumbles more efficiently and cleaning is maximized. (\*Brand names are trademarks of their respective manufacturers.)

### WARNING

For best results, use HE detergents only. Do not use regular detergent, organic detergent, natural detergent or HE detergents with natural ingredients (such as vinegar, baking soda).



---

## Detergent drawer guidelines

---

The washer provides a two-compartment dispenser for detergent and fabric softener. The bleach compartment is located on the left side of the tub.

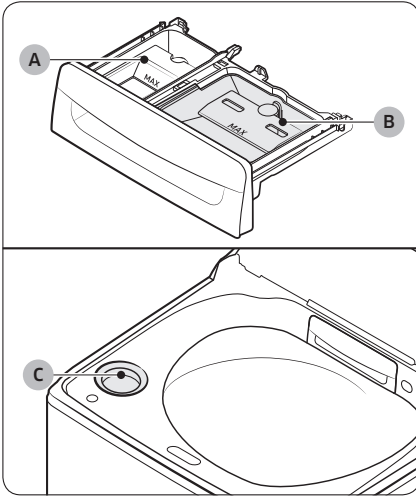

**A. Softener compartment:** Add a recommended amount of fabric softener into the softener compartment.

**B. Detergent compartment:** Apply a recommended amount of liquid detergent into the compartment. To use a powdered detergent, remove the liquid detergent container. The washer does not dispense the powdered detergent from the liquid detergent container.

**C. Bleach compartment:** Add bleach as instructed by the manufacturer.

**NOTE**

- Do not pour color-safe bleach into the bleach compartment.
- Use the softener compartment only for liquid fabric softeners.

**CAUTION**

- Do not open the detergent drawer while the washer is operating.
- Do not put a tablet or capsule type detergents into the detergent drawer. Put them directly into the drum.
- Do not use a ball type detergent.
- To prevent the compartment from clogging, concentrated or highly-enriched agents (fabric softener or detergent) must be diluted with water before being added.

# Before you start

## To add washing agents to the detergent drawer

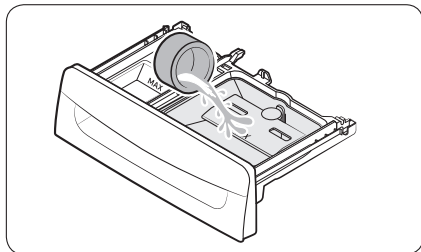

1. Open the lid.
2. Slide open the detergent drawer.
3. Add liquid laundry detergent to the liquid detergent container in the main wash compartment.

### CAUTION

- Make sure the liquid detergent container is inserted in the main wash compartment.

### NOTE

- Do not add powdered laundry detergent or other powdered laundry agents to the liquid laundry container.
- To use powdered detergents, see **To use powdered detergent** on page 31.

4. Add fabric softener to the softener compartment.

### CAUTION

- Powdered fabric softener is not recommended. Use liquid fabric softener only.
- Concentrated fabric softener must be diluted with water before being added.
- Do not add detergent to the softener compartment.

5. Close the detergent drawer.

### NOTE

- Do not exceed the max line when adding cleaning agents.
- It is normal for a small amount of water to remain in the detergent compartment at the end of a cycle.
- When adding color-safe bleach, we recommend that you use liquid detergent.

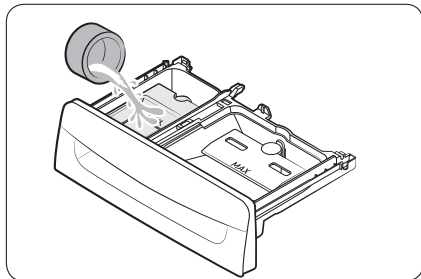

---

## To use powdered detergent

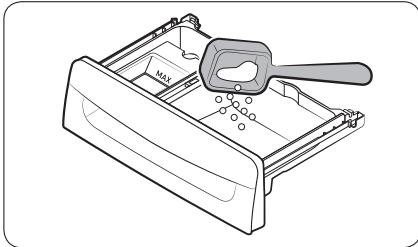

First, remove the provided liquid detergent container from the detergent compartment. Then, add powdered detergent to the detergent compartment according to the detergent manufacturer's instructions.

**⚠ CAUTION**

Do not add powdered detergent to the liquid detergent container.

## To use the bleach compartment

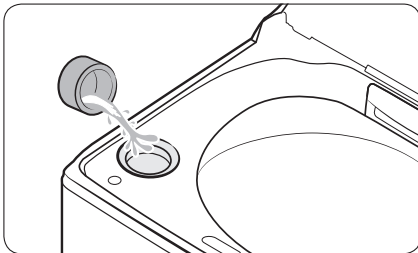

Add only liquid chlorine bleach to the bleach compartment. Do not exceed the max line.

**⚠ CAUTION**

Do not add undiluted liquid chlorine bleach directly to the load or to the tub. This may cause fabric damage.

# Operations

## ⚠ WARNING

To reduce the risk of fire, electric shock, or injury to persons, read the **Safety information** before operating this appliance.

## Control panel

### WA50R5400A\*

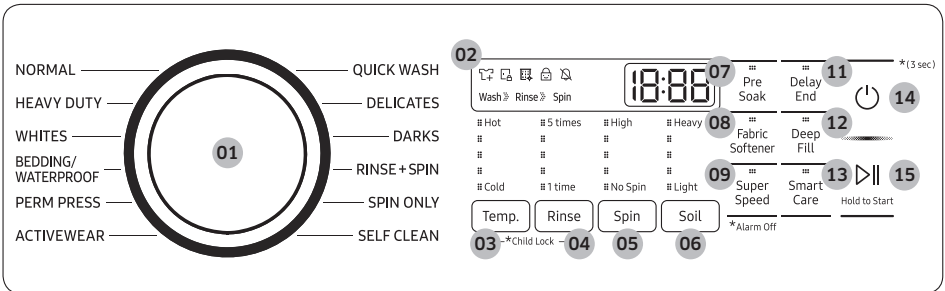

### WA50T5300A\*

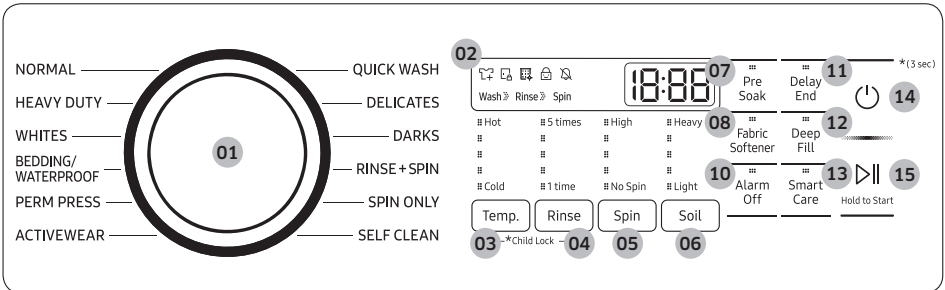





<b>01</b> Cycle Selector	Turn the dial to select a cycle. (For more information about wash cycles, see page 38.)
<b>02</b> Display	The display shows current cycle information and estimated time remaining, or an information code if the washer needs to be checked.

<b>03</b> Temp.	<p>Press to change the water temperature for the current cycle.</p> <ul style="list-style-type: none"> <li>• <b>Hot (Level 5)</b>: Heavily soiled, colorfast items.</li> <li>• <b>(Level 4)</b>: Whites and heavily soiled, colorfast items.</li> <li>• <b>(Level 3)</b>: Colorfast items.</li> <li>• <b>(Level 2)</b>: Brightly colored, very lightly soiled items.</li> <li>• <b>Cold (Level 1)</b>: Uses only cold water without utilizing the washer's the heater. No warm water is supplied.</li> </ul>
<b>04</b> Rinse	<p>Press to change the rinse count for the current cycle.</p> <ul style="list-style-type: none"> <li>• You can select 1 to 5 rinses.</li> </ul>
<b>05</b> Spin	<p>Press to change the spinning speed for the current cycle.</p> <ul style="list-style-type: none"> <li>• <b>High (Level 5)</b>: Extends the spinning process to effectively remove moisture from the load. This level uses a stronger spinning process to remove moisture, so it is not suitable for wrinkle-free or non-iron fabrics, or overloads.</li> <li>• <b>(Level 4)</b>: Underwear, t-shirts, jeans, and sturdy cottons.</li> <li>• <b>(Level 3)</b>: Jeans, wrinkle-free or wash-and wear items, and synthetics.</li> <li>• <b>(Level 2)</b>: Delicate items that require a lower spinning speed.</li> <li>• <b>No Spin (Level 1)</b>: The drum does not spin after the final drain process.</li> </ul> <p><b>Rinse hold</b> (All indicators are off): The final rinse process is suspended so that the laundry remains in the water. To unload the laundry, run a drain or spin cycle.</p>
<b>06</b> Soil	<p>Press to change the soil level for the current cycle.</p> <ul style="list-style-type: none"> <li>• <b>Heavy (Level 5)</b>: For extremely soiled loads.</li> <li>• <b>(Level 4)</b>: For heavily soiled loads.</li> <li>• <b>(Level 3)</b>: For moderately soiled loads. This setting is best for most loads.</li> <li>• <b>(Level 2)</b>: For lightly soiled loads.</li> <li>• <b>Light (Level 1)</b>: For barely soiled loads.</li> </ul>
<b>07</b> Pre Soak	<p>Press to add 18 minutes of soaking time at the start of the wash cycle for better stain removal.</p>
<b>08</b> Fabric Softener	<p>Press to add an additional rinse at the end of the cycle for more thorough removal of laundry additives and perfumes.</p>
<b>09</b> Super Speed (WA50R5400A*)	<p>Press to shorten the washing time of the <b>NORMAL, HEAVY DUTY</b> or <b>WHITES</b> cycles. Shortened time may differ depending on the cycle, load, and options.</p>

# Operations

<b>10</b> Alarm Off (WA50T5300A*)	Press to turn on or off the alarm sound. When the alarm is off, the melody of cycle completion and the power-off beep will not sound. However, button and alert sounds will remain on.
<b>11</b> Delay End	Set the washer to finish your wash automatically at later time. Choose a delay of between 1 to 24 hours (in 1 hour increments). (For more information about Delay End, see page 41.)
<b>12</b> Deep Fill	Use this option where extra water is needed. <b>NOTE</b> The cycle time will be extended when you use this function.
<b>13</b> Smart Care	This function enables you to check the status of the washer using a smartphone.
<b>14</b> Power	Press to turn the washer on or off.
<b>15</b> Start/Pause (Hold to Start)	Press and hold to start operation or press to stop operation temporarily.

## Icon description

	Garment+	<ul style="list-style-type: none"> <li>This icon indicates you can add or take out items after a cycle has started.</li> <li>To add or take out items, press <b>Start/Pause (Hold to Start)</b> to pause the cycle, and then open the lid. To resume the cycle, close the lid, and then press and hold <b>Start/Pause (Hold to Start)</b>.</li> </ul>
	Lid Lock	<ul style="list-style-type: none"> <li>This icon indicates the lid is locked and cannot be opened.</li> <li>The lid locks automatically during a cycle and this indicator turns on.</li> <li>You can open the lid when this icon disappears.</li> </ul>
	SELF CLEAN reminder	<ul style="list-style-type: none"> <li>This icon indicates that you should clean the drum using the SELF CLEAN cycle.</li> <li>After every 20 cycles, this icon appears for an hour and then turns off automatically. The icon will appear for 5 more cycles, turn off, and then will not appear for another 20 cycles.</li> </ul>
	Child Lock	<ul style="list-style-type: none"> <li>This icon indicates that Child Lock is on.</li> <li>For more information about Child Lock, see page 42.</li> </ul>
	Alarm Off	<ul style="list-style-type: none"> <li>This icon indicates that the alarm is off.</li> </ul>

## Simple steps to start

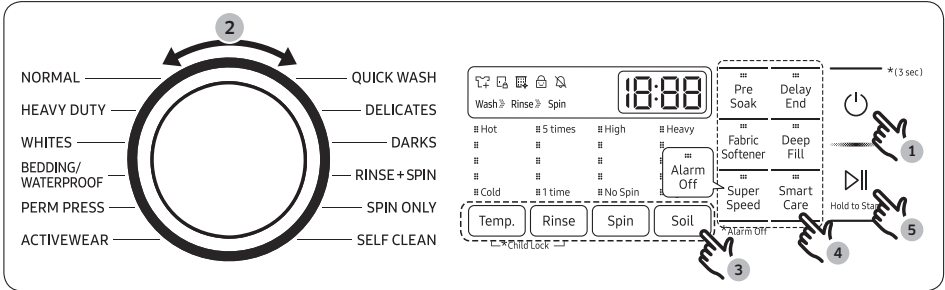

1. Press **Power** to turn on the washer.
2. Turn the **Cycle Selector** to select a cycle.
3. Change the cycle settings (**Temp.**, **Rinse**, **Spin**, and **Soil**) as necessary.
4. Select desired options as necessary.
5. Press and hold **Start/Pause (Hold to Start)**.

### To change the cycle during operation

1. Press **Start/Pause (Hold to Start)** to stop operation.
2. Select a different cycle, and repeat steps 2-3 above if necessary.
3. Press and hold **Start/Pause (Hold to Start)** again to start the new cycle.

# Operations

## Cycle overview

### NOTE

The washer detects the weight of the items and automatically adjusts the optimal water level, washing time, rinse counts, and spin counts. (This may not be applicable on some cycles.)

Cycle	Description
NORMAL	<ul style="list-style-type: none"><li>For cottons, bed linens, table linens, underwear, towels, or shirts. The washing time and the number of rinses are automatically adjusted according to the load.</li></ul>
HEAVY DUTY	<ul style="list-style-type: none"><li>For sturdy, colorfast fabrics, heavily soiled items.</li></ul>
WHITES	<ul style="list-style-type: none"><li>For white items. You can wash with or without bleach.</li></ul>
BEDDING/ WATERPROOF	<ul style="list-style-type: none"><li>For bulky and large items, such as comforters, blankets, and sheets, and waterproof or water resistant items. When washing comforters, use liquid detergent.</li></ul> <p> <b>CAUTION</b></p> <ul style="list-style-type: none"><li>Do not wash waterproof items and non-waterproof items together.</li><li>Check the specification label on each item to see if the item is waterproof.</li><li>Use the <b>BEDDING/WATERPROOF</b> cycle for waterproof or water-resistant items such as plastic mats, ski pants, raincoats, and comforters which hardly absorb water.</li></ul>
PERM PRESS	<ul style="list-style-type: none"><li>For wash-and-wear, synthetic fabrics, and lightly to normally soiled items.</li></ul>
ACTIVEWEAR	<ul style="list-style-type: none"><li>For exercise wear such as sports jerseys, training pants, shirts/tops and other performance clothing. This cycle provides effective soil removal with gentle action for special fabric care.</li></ul>
QUICK WASH	<ul style="list-style-type: none"><li>For lightly soiled garments needed quickly.</li><li>For best performance, recommended load is 4 lb. or lower.</li></ul>
DELICATES	<ul style="list-style-type: none"><li>For sheer fabrics, bras, lingerie (silk), and other handwash-only fabrics.</li><li>For best performance, use liquid detergents.</li></ul>
DARKS	<ul style="list-style-type: none"><li>For casual items with bright or dark colors.</li></ul>



---

Cycle	Description
RINSE+SPIN	<ul style="list-style-type: none"><li>• For loads that need rinsing and spinning only.</li><li>• You can also select this cycle for additional rinsing and spinning after running other cycles.</li></ul>
SPIN ONLY	<ul style="list-style-type: none"><li>• For loads that needs spinning only.</li><li>• You can also select this cycle for additional spinning after running other cycles.</li></ul>
SELF CLEAN	<ul style="list-style-type: none"><li>• Cleans the drum by removing dirt and bacteria from the drum.</li><li>• Perform once every 20 washes.</li><li>• Make sure the drum is empty.</li></ul>

# Operations

## Cycle chart

Use this chart to set the best cycle and options for you laundry.

### NOTE

Setting	Temp.	Rinse	Spin	Soil
● : factory setting	5: Hot (Level 5)	5: 5 times (Level 5)	5: High (Level 5)	5: Heavy (Level 5)
○ : can be selected	4: (Level 4)	4: (Level 4)	4: (Level 4)	4: (Level 4)
	3: (Level 3)	3: (Level 3)	3: (Level 3)	3: (Level 3)
	2: (Level 2)	2: (Level 2)	2: (Level 2)	2: (Level 2)
	1: Cold (Level 1)	1: 1 time (Level 1)	1: No Spin (Level 1)	1: Light (Level 1)

Cycle	Temp.					Rinse					
	5	4	3	2	1	5	4	3	2	1	
NORMAL	○	●	○	○	○	○	○	○	○	○	●
HEAVY DUTY	●	○	○	○	○	○	○	○	○	○	●
WHITES	●	○	○	○	○	○	○	○	○	●	○
DELICATES	-	○	○	●	○	○	○	○	○	○	●
PERM PRESS	○	●	○	○	○	○	○	○	○	○	●
BEDDING/WATERPROOF	○	●	○	○	○	○	○	○	○	●	○
QUICK WASH	○	●	○	○	○	○	○	○	○	○	●
ACTIVE WEAR	-	○	●	○	○	○	○	○	○	○	●
DARKS	-	○	○	●	○	○	○	○	○	○	●
RINSE+SPIN	-	-	-	-	-	○	○	○	○	○	●
SPIN ONLY	-	-	-	-	-	-	-	-	-	-	-
SELF CLEAN	●	-	-	-	-	-	-	-	-	●	-

Cycle	Spin					Soil				
	5	4	3	2	1	5	4	3	2	1
NORMAL	○	●	○	-	○	○	○	●	○	○
HEAVY DUTY	○	●	○	○	○	●	○	○	○	○
WHITES	○	●	○	○	○	●	○	○	○	○
DELICATES	-	-	○	●	○	-	-	-	-	●
PERM PRESS	○	●	○	○	○	○	○	●	○	○
BEDDING/WATERPROOF	-	○	●	○	○	○	○	●	○	○
QUICK WASH	○	●	○	○	○	○	○	○	○	●
ACTIVE WEAR	-	○	●	○	○	-	-	○	●	○
DARKS	○	●	○	○	○	○	○	●	○	○
RINSE+SPIN	○	●	○	○	○	-	-	-	-	-
SPIN ONLY	○	●	○	○	○	-	-	-	-	-
SELF CLEAN	-	-	●	-	-	-	-	-	-	-

Cycle	Options			
	Pre Soak	Fabric Softener	Deep Fill	Super Speed (WA50R5400A*)
NORMAL	○	○	-	○
HEAVY DUTY	○	○	○	○
WHITES	○	○	○	○
DELICATES	-	○	○	-
PERM PRESS	○	○	○	-
BEDDING/WATERPROOF	○	○	-	-
QUICK WASH	-	○	○	-
ACTIVE WEAR	○	○	○	-
DARKS	-	○	○	-
RINSE+SPIN	-	○	○	-
SPIN ONLY	-	-	-	-
SELF CLEAN	-	-	-	-

# Operations

## Special features

### Active Waterjet (for prewash)



You can use the Active Waterjet function to hand-wash your items before you put them in the washer.

1. Press **Power** to turn on your washer.
2. Open the lid.
3. Press **Active Waterjet** to supply water.
4. Hand-wash the items.
5. When done, press **Active Waterjet** again to stop the water.

#### **NOTE**

If you want to hand-wash while the washer is operating, press **Start/Pause (Hold to Start)** to stop operation, and then follow steps 1-4 above.

#### **NOTE**

- The Active Waterjet function stops operating automatically when the washer detects the maximum water level.
- The Active Waterjet function stops operating automatically 5 minutes after it begins. To add more water, press **Active Waterjet** again to resupply water.
- If the Active Waterjet function is activated immediately after the washer turns on, the washer will spray water for 1 second before supplying water through the Active Waterjet outlet.
- To drain water added by the Active Waterjet function, turn the power off. Water will be drained automatically for few minutes, and then you can turn the power on again when the water is completely drained.

#### **CAUTION**

- Do not block the Active Waterjet outlet with hands. Water may leak outside the tub, causing a system failure.
- Do not use the Active Waterjet to wash shoes, food, or pets.
- Due to differences in air pressure, water coming from the Active Waterjet may splatter when you first activate it.

- 
- Make sure the lid is closed tightly before you start a load of laundry.

### Delay End

You can set the washer to finish your wash automatically at a later time by choosing a delay of between 1 to 24 hours (in 1 hour increments). The hour displayed indicates the time the wash will finish.

1. Select a cycle. Then, change the cycle settings if necessary.
2. Press **Delay End** repeatedly until a desired end time is set.
3. Press and hold **Start/Pause (Hold to Start)**.
4. To cancel Delay End, restart the washer by pressing **Power**.

### Real-life case

You want to finish a two-hour cycle 3 hours from now. To do this, you add the Delay End option to the current cycle with a 3-hour setting, and then press and hold **Start/Pause (Hold to Start)** at 2:00 pm. The washer starts operating at 3:00 pm and ends at 5:00 pm. Provided below is the time line for this example.



### Alarm Off (WA50R5400A\*)

You can turn the alarm sound on or off. When the alarm is off, the cycle completion melody and the power-off beep will not sound. However, button and alert sounds will remain on.

- To mute the alarm sound, press and hold **Super Speed** for 3 seconds.
- To unmute the alarm sound, press and hold again for 3 seconds.
- Your setting will be kept even after you turn off and then restart the machine.

# Operations

## ATC (Auto Temperature Control)

ATC enables the washer to control water temperatures in each washing cycle using the internal thermistor. It is designed to maintain certain washing temperatures for best results.

### NOTE

- If you select **NORMAL** or **HEAVY DUTY**, you may notice the washer supplying cold water. This is normal because the machine is designed to reduce power consumption. In these cycles, the water temperature for Level 5 is similar to bath-water temperatures, and Level 3 is similar to comfortable swimming pool temperatures.
- To wash clothes at a specific temperature, you must choose a different cycle first.

## Child Lock

The Child Lock function locks the washer door to prevent children from climbing into and suffocating inside the tub.

### Activating the Child Lock function

Press and hold **Temp.** and **Rinse** simultaneously for approximately 3 seconds.

- When you activate the Child Lock function, the  **Child Lock** indicator blinks.

### Using the Child Lock function

If the lid is opened when the Child Lock function is on, “**dC**” is displayed and an alarm sounds.

- If the water level in the tub is above the safe water level, “**dC**” is displayed on the LED display and the washer starts to drain water by force after 30 seconds.
- If the water level in the tub is above the safe water level and the Child Lock function is turned on while the lid is open, “**CL**” is displayed on the LED display, even if the washer is turned off, and the washer drains water by force.
- When Child Lock is on and the washer is off, if the water in the tub is above the safe water level and the lid is opened, “**CL**” is displayed on the LED display. No alarm sounds, but the washer drains the water. When the draining operation finishes, the power automatically turns off again.
- If you activate the Child Lock function while the washer is running, the **Start/Pause (Hold to Start)** button will not work.
- After the compulsory drain, “**CL**” blinks at 1 second intervals and the washer enters the “**CL**” mode. (When the washer is in the “**CL**” mode, only the **Power** button works.)
- To cancel the “**CL**” mode, turn the power off and then on again.
- To cancel the “**dC**” mode, deactivate the Child Lock function. To deactivate the Child Lock function, press and hold **Temp.** and **Rinse** simultaneously for at least 3 seconds.

---

## Deactivating the Child Lock function

Press and hold both **Temp.** and **Rinse** simultaneously for approximately 3 seconds.

- When you deactivate the Child Lock function, the  **Child Lock** indicator is turned off.
- The Child Lock function prevents children or the infirm from accidentally operating the washer and injuring themselves.

### **WARNING**

If a child enters the washer, the child may become trapped and suffocate.

### **CAUTION**

- Once you have activated the Child Lock function, it continues working even if the power is turned off.
- Forcing the lid open can result in injury or damage to the product.

### **NOTE**

To add laundry after you have activated the Child Lock function, you must first deactivate the Child Lock function.

---

## Smart Care

To enable this function, you must first download the Samsung Laundry app from the Play Store or the App Store and install it on a mobile device that has a camera function. The Smart Care function has been optimized for Galaxy and iPhone mobile devices (applicable models only).

1. When the washer detects an issue to check, an information code appears on the display. To enter Smart Care mode, press **Smart Care**.
2. The washer starts the self-diagnosis procedure and displays an information code if a problem is detected.
3. Run the Samsung Laundry app on your mobile device, and then tap **Smart Care**.
4. Put the mobile device close to the washer's display so that the smartphone camera and the washer face each other. The information code will be recognized automatically by the app.
5. When the information code is recognized correctly, the app provides detailed information about the problem with applicable solutions.

### **NOTE**

- The function name, Smart Care, may differ depending on the language.
- If the washer's display reflects light, the app may fail to recognize the information code.
- If the app fails to recognize the information code, you can enter the code manually on the app.

# Maintenance

---

Keep the washer clean for best performance and to lengthen its life cycle.

## **WARNING**

Certain internal parts are intentionally not grounded and may present a risk of electric shock only during servicing. Service personnel – Do not contact the following parts while the appliance is energized: Control board, heat sink, motor, inlet valve, heater, and pump.

## **Self Clean**

---

Certain usage and environmental conditions may result in some residue build-up or odor in the washer tub. To prevent this build-up of residue or odor causing bacteria and keep your washer tub fresh and clean, perform the SELF CLEAN cycle at least once a month or every 20 cycles. Perform the recommended procedure below when using the SELF CLEAN cycle.

1. Remove all items from the washer tub and ensure the tub is empty. Laundry left in the tub during the SELF CLEAN cycle may be damaged.
2. Press **Power** to turn on the washer.
3. Turn the **Cycle Selector** to **SELF CLEAN**.
4. Press and hold **Start/Pause (Hold to Start)**.

## **NOTE**

- The water temperature for SELF CLEAN is defaulted to Hot. This temperature cannot be changed.
- In the case where residue is present in the washer tub, add 1 cup (8 fl.oz, 240ml) of liquid chlorine bleach to the bleach compartment before you start the SELF CLEAN cycle.
- Do not use or mix any other detergent or chemicals during the SELF CLEAN cycle. If necessary, run a RINSE+SPIN cycle after the SELF CLEAN cycle has completed to help remove any remaining residue.

## **CAUTION**

- Check the washer tub before using the SELF CLEAN cycle. Remove any remaining water in the tub by running a SPIN ONLY cycle prior to starting the SELF CLEAN cycle.
- If there is chlorine bleach left in the washer tub for an extended period of time, rust can occur.

## **SELF CLEAN reminder**

- After 20 washing cycles, the SELF CLEAN LED reminder icon and the SELF CLEAN cycle LED will blink on the control panel for an hour and then turn off automatically.
- The reminder will appear on the control panel for 5 additional consecutive cycles before turning off. The next reminder will not appear until another 20 cycles have been completed.



---

## Cleaning the exterior

---

1. Turn off the water taps after finishing the day's washing. This will shut off the water supply to your washer and prevent the unlikely possibility of damage from escaping water. Leave the lid open to allow the inside of your washer to dry out.
2. Use a soft cloth to wipe up all detergent, bleach, or other spills as they occur. Clean the following as recommended below:
  - Control Panel – Clean with a soft, damp cloth. Do not use abrasive powders or cleaning pads. Do not spray cleaners directly on the panel.
  - Cabinet – Clean with soap and water.

---

## Cleaning the interior

---

Clean the interior of your washer periodically to remove any dirt, soil, odor, mold, mildew, or bacterial residue that may remain in your washer as a result of washing clothes.

### CAUTION

Failure to follow these instructions may result in unpleasant conditions, including odors and/or permanent stains on your washer or laundry.

### NOTE

Hard water deposits may be removed, if needed. Use a cleaner labeled "Washer safe".

---

## Care for an extended period of non-use

---

Avoid leaving the washer unused for an extended time. However, if you intend to leave the washer unused for a long period of time, follow the directions below:

1. Press **Power**, and then turn the **Cycle Selector** to **QUICK WASH**.
2. Empty the drum, and then press and hold **Start/Pause (Hold to Start)**.
3. When the cycle is complete, close the water taps and disconnect the water hoses.
4. Turn off the washer, and then unplug the power cord.
5. Open the door to let air circulate through the drum.

# Maintenance

## Cleaning the mesh filter

Clean the mesh filters in the water inlets once or twice a year.

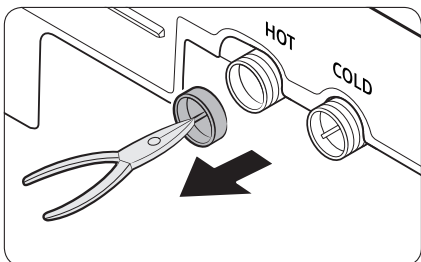
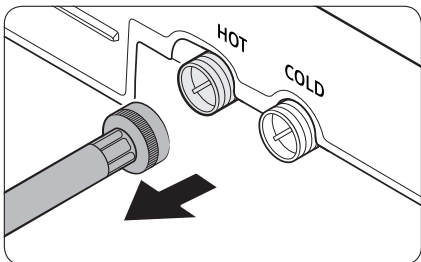

1. Turn off the washer, and then unplug the power cord.
2. Close the water taps.
3. Loosen and disconnect the water hoses from the back of the washer. Cover the each hose with a cloth or towel to prevent water from gushing out.
4. Use pliers to pull out the mesh filter from the inlet valves.
5. Thoroughly clean the mesh filters in water.
6. Completely dry the mesh filters. Do not dry in direct sunlight.
7. Reinsert the mesh filters, and then reconnect the water hoses.
8. Open the water taps.

### NOTE

If a mesh filter is clogged, the “4C” information code appears on the washer’s display screen.

---

## Cleaning the detergent drawer

---

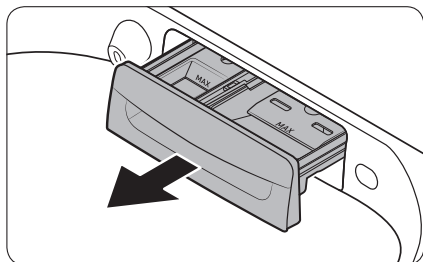

1. Fully pull out the detergent drawer.

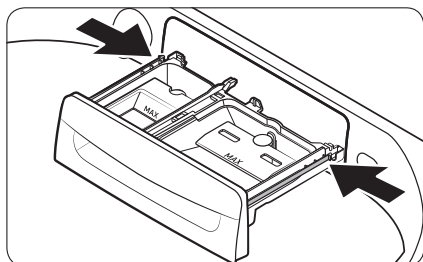

2. To remove, pull the detergent drawer while pushing the ends of each side in.

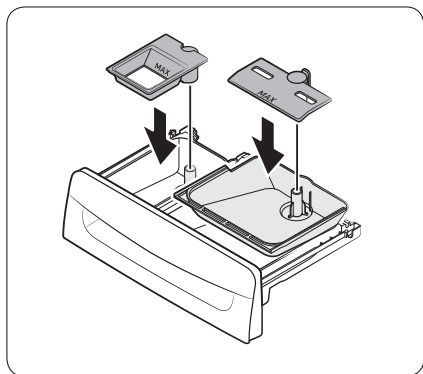

3. Remove the inserts from the compartments. Rinse the inserts and the drawer in warm water and clean with a soft brush.

# Maintenance

---

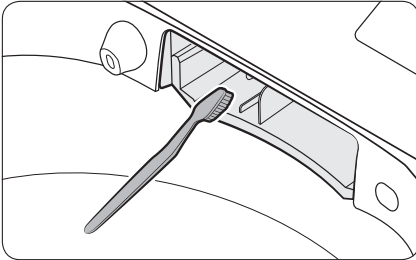

4. Clean the drawer opening thoroughly with a small, non-metallic brush.

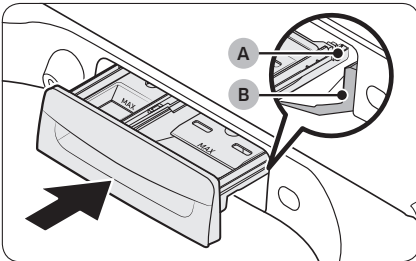

5. Return the inserts to the proper compartments. Replace the drawer by placing the **drawer rail (A)** on the **compartment rail (B)** while tilting the drawer downward.
6. Fully push the drawer back to close.

# Troubleshooting

## Checkpoints

If you encounter a problem with the washer, first check the table below and try the suggestions.

Problem	Action
Does not turn on.	<ul style="list-style-type: none"><li>• Make sure your home electrical system is providing electrical power that matches the requirements of the washer. See page 16.</li><li>• Make sure the power cord is completely plugged in.</li><li>• Check the fuse or reset the circuit breaker.</li><li>• If you have turned the power off to drain the water added by the Active Waterjet function, power does not turn on until the water is completely drained.</li></ul>
Does not start.	<ul style="list-style-type: none"><li>• Make sure the door is closed.</li><li>• Make sure the water taps are open.</li><li>• Make sure to press or tap <b>Start/Pause (Hold to Start)</b> to start the washing machine.</li><li>• Make sure Child Lock is not activated.</li><li>• Before the washing machine starts to fill, it will make a series of clicking noises to check the door lock, and then does a quick drain.</li><li>• Was the door opened during the spinning cycle? Close the door, and then press or tap <b>Start/Pause (Hold to Start)</b> to resume.</li><li>• The machine has entered Standby, has paused, or is in a soaking cycle. Please wait.</li><li>• Check the fuse or reset the circuit breaker.</li></ul>

# Troubleshooting

Problem	Action
Water is not supplied.	<ul style="list-style-type: none"> <li>• Make sure you press or tap <b>Start/Pause (Hold to Start)</b> after selecting the cycle and options.</li> <li>• Make sure the water taps are open.</li> <li>• Are the mesh filters in the water inlets clogged? Clean the mesh filters by brushing with a toothbrush. See page 46.</li> <li>• Is the water supply cut off? If the water supply is cut off, close the tap and power off.</li> <li>• Straighten the water supply hoses.</li> <li>• Open and close the door, and then press or tap <b>Start/Pause (Hold to Start)</b>.</li> <li>• If the water pressure is low, it takes longer to start washing.</li> <li>• If the water level is not as high as necessary or lower than expected, use the level selector to adjust the water level.</li> </ul>
After a cycle, detergent remains in the automatic dispenser.	<ul style="list-style-type: none"> <li>• Make sure the washing machine is running with sufficient water pressure.</li> <li>• Make sure the detergent drawer is properly inserted.</li> <li>• Remove and clean the detergent drawer, and then try again.</li> </ul>
Vibrates excessively or makes noise.	<ul style="list-style-type: none"> <li>• Make sure the washing machine is on a level floor. If the floor is not level, use the levelling feet to adjust the washing machine.</li> <li>• Make sure the washing machine is not contacting any other object.</li> <li>• Make sure the laundry load is balanced.</li> <li>• Make sure the laundry is spread evenly in the washing machine. Spread out the laundry evenly and start again.</li> <li>• Make sure the space around the washing machine is free of objects.</li> <li>• Humming is produced normally during operation.</li> <li>• Objects such as coins can cause noise. Remove these objects from the washing machine after washing is complete.</li> </ul>

Problem	Action
Stops.	<ul style="list-style-type: none"> <li>• Make sure the washer's power cord is fully plugged in and the circuit is live.</li> <li>• Check the fuse or reset the circuit breaker.</li> <li>• Close the door, and then press or tap <b>Start/Pause (Hold to Start)</b> to start the washing machine. For your safety, the washing machine will not spin unless the door is closed.</li> <li>• Before the washing machine starts to fill, it will make a series of clicking noises to check the door lock, and then does a quick drain.</li> <li>• There may be a pause or soak period in the cycle. Wait briefly and the washing machine may start.</li> <li>• Make sure the inlet hose filters at the taps are not clogged. Periodically clean the filters. See page 47.</li> <li>• This problem can occur temporarily due to low voltage in your household electrical system. It will be resolved when the voltage returns to normal.</li> </ul>
Fills with the wrong temperature water.	<ul style="list-style-type: none"> <li>• Fully open both water taps.</li> <li>• Make sure the temperature selection is correct.</li> <li>• Make sure the hoses are connected to the correct water taps. Flush the water lines.</li> <li>• Disconnect the hoses and clean the mesh filters. The water inlet mesh filters may be clogged. See page 46.</li> <li>• While the washing machine fills, the water temperature may change as the automatic temperature control feature checks incoming water temperature. This is normal.</li> <li>• While the washing machine fills, you may notice just hot and/or just cold water going through the dispenser when cold or warm temperatures are selected. This is a normal function of the automatic temperature control feature as the washing machine determines the water temperature.</li> </ul>
Door (Lid) locked or will not open.	<ul style="list-style-type: none"> <li>• While the washing machine is operating, press or tap <b>Start/Pause (Hold to Start)</b> to stop the washing machine.</li> <li>• It may take a few moments for the door lock mechanism to disengage.</li> </ul>

# Troubleshooting

Problem	Action
Does not drain and/or spin.	<ul style="list-style-type: none"> <li>• Check the fuse or reset the circuit breaker.</li> <li>• Make sure the electrical voltage is normal.</li> <li>• Make sure the washing machine is plugged in.</li> <li>• Make sure the drain hose is pointed downward. (Natural drain models only)</li> <li>• Make sure the drain hose is not clogged.</li> <li>• Make sure the drain hose is not kinked.</li> <li>• Straighten the drain hose. If there is a drain restriction, call for service.</li> <li>• Close the door, and then press or tap <b>Start/Pause (Hold to Start)</b>. For your safety, the washing machine will not spin unless the door is closed.</li> </ul>
Load is wet at the end of the cycle.	<ul style="list-style-type: none"> <li>• Use the High or Extra High spin speed cycle. (Applicable model only)</li> <li>• Use high efficiency (HE) detergent to reduce oversudsing.</li> <li>• The load is too small. Small loads (one or two items) may become unbalanced and not spin completely.</li> </ul>
Leaks water.	<ul style="list-style-type: none"> <li>• Make sure all hose connections are tight.</li> <li>• Make sure the water supply hoses' rubber washers are in the correct position. Screw the hoses on tightly again. See pages <b>19</b> through <b>21</b>.</li> <li>• Make sure the end of the drain hose is correctly inserted and secured to the drain system.</li> <li>• Avoid overloading.</li> <li>• Use high efficiency (HE) detergent to prevent oversudsing.</li> <li>• Make sure the water supply hose is not kinked.</li> <li>• If the water supply pressure is too strong, water may leak. Close the water tap a little.</li> <li>• Make sure water is not leaking from the water tap. If it is, repair the water tap.</li> </ul>
Excessive suds.	<ul style="list-style-type: none"> <li>• Use high efficiency (HE) detergent to prevent oversudsing.</li> <li>• Reduce the detergent amount for soft water, small loads, or lightly soiled loads.</li> <li>• Don't use Non-HE detergent.</li> </ul>





Problem	Action
<p>The spin basket or drain/supply hose is frozen.</p>	<ul style="list-style-type: none"> <li>• Use warm water to help loosen the water supply hoses and drain hose, and then disconnect them. Soak them in warm water.</li> <li>• Fill the spin basket with warm water, and then wait for about 10 minutes.</li> <li>• Put a hot towel on the drain hose connector.</li> <li>• Reconnect the water supply hoses and drain hose, and then check if water is supplied properly.</li> </ul>
<p>Water drains out immediately.</p>	<ul style="list-style-type: none"> <li>• Make sure the drain hose is not clogged, and is hung over the drain hose hook. Fill the spin basket halfway with water, and try spinning again.</li> <li>• Lift the end of the drain hose to prevent water from draining. Fill the spin basket halfway with water, and then run the Spin cycle after releasing the drain hose.</li> <li>• Make sure the drain hose is installed correctly. See the pages <b>21</b> and <b>22</b>. Adjust the position of the drain hose as instructed.</li> </ul>
<p>Stains on clothes.</p>	<ul style="list-style-type: none"> <li>• Select an appropriate cycle for the laundry. Use the HEAVY DUTY cycle for stained clothes.</li> <li>• Apply a recommended amount of detergent as instructed by the detergent manufacturer.</li> <li>• Clean the magic filter (if it comes with your washer) on a regular basis.</li> </ul>
<p>Has odors.</p>	<ul style="list-style-type: none"> <li>• Excessive suds collect in recesses and can cause foul odors.</li> <li>• Run a SELF CLEAN cycle to sanitize periodically.</li> <li>• Dry the washing machine interior after a cycle has finished.</li> </ul>
<p>Thumping sound</p>	<ul style="list-style-type: none"> <li>• Heavy wash loads may cause a thumping sound, and it is normal.</li> <li>• If the thumping sound continues, the washer may be out of balance. Stop the washer and redistribute the load in the washer.</li> </ul>

If a problem persists, contact a local Samsung service center.

# Troubleshooting

## Information codes

The washer may display information codes to help you understand what is occurring with your washer better.

Code	Meaning
1C	<p>The Water Level sensor is not working properly.</p> <ul style="list-style-type: none"><li>• Turn off the washer, unplug it, wait 30 seconds, and then plug the washer in again. If the information code remains, contact a Samsung customer service center.</li></ul> <p> <b>NOTE</b></p> <p>If the washer displays “1C”, the washer will automatically drain for 3 minutes. During this time, the <b>Power</b> button is inoperative.</p>
3C	<p>Check the motor for operation.</p> <ul style="list-style-type: none"><li>• Try restarting the cycle.</li><li>• If the problem continues, call for service.</li></ul>
4C	<p>Water is not supplied.</p> <ul style="list-style-type: none"><li>• Make sure the water taps are open.</li><li>• Make sure the water hoses are not clogged.</li><li>• Make sure the water taps are not frozen.</li><li>• Make sure the washing machine is operating with sufficient water pressure.</li><li>• Make sure that the cold water tap and the hot water tap are properly connected.</li><li>• Clean the mesh filter as it may be clogged.</li><li>• Make sure water hoses are not kinked.</li></ul> <p> <b>NOTE</b></p> <p>If the washer displays “4C”, the washer will automatically drain for 3 minutes. During this time, the <b>Power</b> button is inoperative.</p>
4C2	<ul style="list-style-type: none"><li>• Make sure the cold water supply hose is firmly connected to the cold water tap. If it is connected to the hot water tap, laundry may be damaged when some cycles are run.</li></ul>

Code	Meaning
5C	<p>Water is not draining.</p> <ul style="list-style-type: none"> <li>• Make sure the drain hose is not frozen or clogged.</li> <li>• Make sure the drain hose is positioned correctly, depending on the connection type.</li> <li>• Clean the mesh debris filter as it may be clogged.</li> <li>• Make sure the drain hose is straight all the way to the drain system.</li> <li>• Turn off the washer, unplug it, wait one minute, and then plug the washer in again. If the information code remains, contact a Samsung customer service center.</li> </ul>
9C1	<p>The electronic control needs to be checked (Over Voltage Error).</p> <ul style="list-style-type: none"> <li>• Check if power is supplied properly.</li> <li>• Turn off the washer, unplug it, wait one minute, and then plug the washer in again. If the information code remains, contact a Samsung customer service center.</li> </ul>
9C2	<p>Low voltage detected.</p> <ul style="list-style-type: none"> <li>• Check if the power cord is plugged in.</li> <li>• Turn off the washer, unplug it, wait one minute, and then plug the washer in again. If the information code remains, contact a Samsung customer service center.</li> </ul>
AC6	<p>Inverter Communication problem.</p> <ul style="list-style-type: none"> <li>• Turn off the washer, unplug it, wait one minute, and then plug the washer in again. If the information code remains, contact a Samsung customer service center.</li> </ul>
dC	<p>Operating the washer with the door open.</p> <ul style="list-style-type: none"> <li>• Make sure the door is properly closed.</li> <li>• Make sure laundry is not caught in the door.</li> </ul>
HC	<p>High temperature heating check.</p> <ul style="list-style-type: none"> <li>• Turn off the washer, unplug it, wait one minute, and then plug the washer in again. If the information code remains, contact a Samsung customer service center.</li> </ul>

# Troubleshooting

Code	Meaning
LC	<p>Check the drain hose.</p> <ul style="list-style-type: none"> <li>• Make sure the end of the drain hose is positioned correctly.</li> <li>• Make sure the drain hose is not clogged.</li> <li>• Turn off the washer, unplug it, wait one minute, and then plug the washer in again. If the information code remains, contact a Samsung customer service center.</li> </ul> <p> <b>NOTE</b></p> <p>When the washer displays “LC”, the washer drains for 3 minutes. During this time, the <b>Power</b> button is inoperative.</p>
OC	<p>Water overflowed.</p> <ul style="list-style-type: none"> <li>• Restart after spinning.</li> <li>• Turn off the washer, unplug it, wait one minute, and then plug the washer in again. If the information code remains, contact a Samsung customer service center.</li> </ul>
PC	<p>When position of the clutch can't be detected.</p> <ul style="list-style-type: none"> <li>• Turn off the washer, unplug it, wait one minute, and then plug the washer in again. If the information code remains, contact a Samsung customer service center.</li> </ul>
PC1	<p>After position of the clutch is detected, if the signal from the clutch hall is incorrect.</p> <ul style="list-style-type: none"> <li>• Turn off the washer, unplug it, wait one minute, and then plug the washer in again. If the information code remains, contact a Samsung customer service center.</li> </ul>
Ub	<p>Spinning does not work.</p> <ul style="list-style-type: none"> <li>• Make sure laundry is spread out evenly.</li> <li>• Make sure the washing machine is on a flat, stable surface.</li> <li>• Redistribute the load. If only one item of clothing needs washing, such as a bathrobe or pair of jeans, the final spin result might be unsatisfactory, and a “Ub” check message will appear in the display.</li> </ul>
Ur	<p>Display for additional rinsing.</p> <ul style="list-style-type: none"> <li>• Appears when additional rinsing cycle senses that tub is unbalanced.</li> <li>• Press any button/key to release the display.</li> </ul>

Code	Meaning
8C	Check the MEMS sensor. <ul style="list-style-type: none"> <li>• Power the washer off. Wait 2-3 minutes, power the washer on, and then try again.</li> <li>• If the problem continues, call for service.</li> </ul>
dn	Firmware update is in progress through SmartThings. <ul style="list-style-type: none"> <li>• To use the product, wait about 30 minutes until the firmware update completes. (The time required to complete the firmware update may vary depending on your Internet connection.)</li> <li>• This code will remain on the display, regardless of power on and off, until the firmware update is complete.</li> </ul>

For any codes not listed above, call 1-800-726-7864 (1-800-SAMSUNG).

# Specifications

## Fabric care chart

The following symbols provide garment care direction. The clothing care labels include symbols for drying, bleaching, drying and ironing, or dry cleaning when necessary. The use of symbols ensures consistency among garment manufacturers of domestic and imported items. Follow care label directions to optimize garment life and reduce laundering problems.

### Wash cycle

	Normal
	Permanent press/Wrinkle resistant/Wrinkle control
	Gentle/Delicates
	Hand wash

### Water temperature

...	Hot
..	Warm
.	Cold

### NOTE

This represents appropriate wash water temperatures for various items. The temperature range for Hot is 105° - 125 °F / 41° - 52 °C, for Warm 85° - 105 °F / 29° - 41 °C, and for Cold 60° - 85 °F / 16° - 29 °C. (Wash water temperature must be a minimum of 60 °F / 16 °C for detergent activation and effective cleaning.)

The clothes washer can not ensure these temperatures because the actual temperature of the water entering your washer depends on water heater settings and regional water supply temperatures. For example, cold water entering the home in the northern states during winter may be 40 °F / 4 °C which is too cold for effective cleaning. In this situation, you will need to adjust the water temperature by selecting a warm setting, adding some hot water to the MAX FILL line, or using your washer's heating option, if available.

### Bleach

	Any bleach (when needed)
	Only non-chlorine (color-safe) bleach (when needed)
	Tumble dry





### Normal

	Permanent press/Wrinkle resistant/Wrinkle control
	Gentle/Delicates



### Special instructions

	Line dry/Hang to dry
	Drip dry
	Dry flat







## Heat setting

	High
	Medium
	Low
	Any heat
	No heat / Air





## Iron dry or steam temperatures

	High
	Medium
	Low

## Warning symbols for laundering

	Do not wash
	Do not wring
	Do not bleach
	Do not tumble dry
	No steam (added to iron)
	Do not iron

## Dry-clean

	Dry-clean
	Do not dry-clean
	Line dry / Hang to dry
	Drip dry
	Dry flat

## Helping the environment

- Your washer is manufactured from recyclable materials. If you decide to dispose of it, please observe local waste disposal regulations. Cut off the power cord so that the appliance cannot be connected to a power source. Remove the lid so that animals and small children cannot get trapped inside the appliance.
- Do not exceed the detergent quantities recommended in the detergent manufacturers' instructions.
- Use stain removal products and bleaches before the wash cycle only when necessary.
- Save water and electricity by only washing full loads (the exact amount depends upon the program used).

# Specifications

---

## Declaration of conformity

---

This appliance complies with UL2157.

## Specification sheet

---

Type		Top loading washer	
Model name		WA50R5400A*/WA50T5300A*	
Water pressure (psi (kPa))		20-116 (137-800)	
Spin revolution		750 rpm	
NET weight (lb (kg))		132 (60)	
Power consumption	Washing	120 V	700 W



# LIMITED WARRANTY (U.S.A.)

---

## SAMSUNG WASHER

---

### LIMITED WARRANTY TO ORIGINAL CONSUMER PURCHASER WITH PROOF OF PURCHASE

This SAMSUNG brand product, as supplied and distributed by SAMSUNG ELECTRONICS AMERICA, INC. (SAMSUNG) and delivered new, in the original carton to the original consumer purchaser, is warranted by SAMSUNG against manufacturing defects in materials or workmanship for the limited warranty period, starting from the date of original purchase, of:

Parts and labor : One (1) year

Stainless tub part (Part Only) : Three (3) years

Washing motor follow motor type

- Washing DIT (Digital Inverter Motor) motor part (Part Only):
  - Ten (10) years
  - Twenty (20) years: Limited to “U.S.-assembled” washers only
- Washing AC motor part (Part Only):
  - Five (5) years

This limited warranty is valid only on products purchased and used in the United States that have been installed, operated, and maintained according to the instructions attached to or furnished with the product. To receive warranty service, the purchaser must contact SAMSUNG at the address or phone number provided below for problem determination and service procedures. Warranty service can only be performed by a SAMSUNG authorized service center. The original dated bill of sale must be presented upon request as proof of purchase to SAMSUNG or SAMSUNG’s authorized service center to receive warranty service.

SAMSUNG will provide in-home service within the contiguous United States during the warranty period at no charge, subject to availability of SAMSUNG authorized servicers within the customer’s geographic area. If in-home service is not available, SAMSUNG may elect, at its option, to provide transportation of the product to and from an authorized service center. If the product is located in an area where service by a SAMSUNG authorized servicer is not available, you may be responsible for a trip charge or required to bring the product to a SAMSUNG authorized service center for service.

To receive in-home service, product must be unobstructed and accessible to the service agent.

# LIMITED WARRANTY (U.S.A.)

---

During the applicable warranty period, a product will be repaired, replaced, or the purchase price refunded, at the sole option of SAMSUNG. SAMSUNG may use new or reconditioned parts in repairing a product, or replace the product with a new or reconditioned product. SAMSUNG may also replace any part covered by this warranty with a new or reconditioned part. Replacement parts and products are warranted for the remaining portion of the original product's warranty or ninety (90) days, whichever is longer. All replaced parts and products are the property of SAMSUNG and you must return them to SAMSUNG.

This limited warranty covers manufacturing defects in materials or workmanship encountered in normal household, noncommercial use of this product and shall not cover the following: damage that occurs in shipment, delivery, installation, and uses for which this product was not intended; damage caused by unauthorized modification or alteration of the product; product where the original factory serial numbers have been removed, defaced, changed in any way, or cannot be readily determined; cosmetic damage including scratches, dents, chips, and other damage to the product's finishes; damage caused by abuse, misuse, pest infestations, accident, fire, floods, or other acts of nature or God; damage caused by use of equipment, utilities, services, parts, supplies, accessories, applications, installations, repairs, external wiring or connectors not supplied or authorized by SAMSUNG; damage caused by incorrect electrical line current, voltage, fluctuations and surges; damage caused by failure to operate and maintain the product according to instructions; in-home instruction on how to use your product; and service to correct installation not in accordance with electrical or plumbing codes or correction of household electrical or plumbing (i.e., house wiring, fuses, or water inlet hoses). The cost of repair or replacement under these excluded circumstances shall be the customer's responsibility.

Visits by an authorized servicer to explain product functions, maintenance or installation are not covered by this limited warranty. Please contact SAMSUNG at the number below for assistance with any of these issues.

## **EXCLUSION OF IMPLIED WARRANTIES**

IMPLIED WARRANTIES, INCLUDING THE IMPLIED WARRANTIES OF MERCHANTABILITY OR FITNESS FOR A PARTICULAR PURPOSE, ARE LIMITED TO ONE YEAR OR THE SHORTEST PERIOD ALLOWED BY LAW. Some states do not allow limitations on how long an implied warranty lasts, so the above limitations or exclusions may not apply to you. This warranty gives you specific rights, and you may also have other rights, which vary from state to state.

---

## **LIMITATION OF REMEDIES**

YOUR SOLE AND EXCLUSIVE REMEDY IS PRODUCT REPAIR, PRODUCT REPLACEMENT, OR REFUND OF THE PURCHASE PRICE AT SAMSUNG'S OPTION, AS PROVIDED IN THIS LIMITED WARRANTY. SAMSUNG SHALL NOT BE LIABLE FOR SPECIAL, INCIDENTAL OR CONSEQUENTIAL DAMAGES, INCLUDING BUT NOT LIMITED TO TIME AWAY FROM WORK, HOTELS AND/OR RESTAURANT MEALS, REMODELING EXPENSES, LOSS OF REVENUE OR PROFITS, FAILURE TO REALIZE SAVINGS OR OTHER BENEFITS REGARDLESS OF THE LEGAL THEORY ON WHICH THE CLAIM IS BASED, AND EVEN IF SAMSUNG HAS BEEN ADVISED OF THE POSSIBILITY OF SUCH DAMAGES. Some states do not allow exclusion or limitation of incidental or consequential damages, so the above limitations or exclusions may not apply to you. This warranty gives you specific rights, and you may also have other rights, which vary from state to state.

SAMSUNG does not warrant uninterrupted or error-free operation of the product. No warranty or guarantee given by any other person, firm, or corporation with respect to this product shall be binding on SAMSUNG.

To obtain warranty service, please contact SAMSUNG at:

**Samsung Electronics America, Inc.**

**85 Challenger Road**

**Ridgefield Park, NJ 07660**

**1-800-SAMSUNG (726-7864)**

**[www.samsung.com/us/support](http://www.samsung.com/us/support)**



Scan the QR code\* or visit  
[www.samsung.com/spsn](http://www.samsung.com/spsn)  
to view our helpful  
How-to Videos and Live Shows

\*Requires reader to be installed on your smartphone

Scan this with your smartphone

## QUESTIONS OR COMMENTS?

COUNTRY	CALL	OR VISIT US ONLINE AT
U.S.A	1-800-SAMSUNG (726-7864)	<a href="http://www.samsung.com/us/support">www.samsung.com/us/support</a>

