



Samsung Air Purifier

User manual

AX300T9080S, AX300T9080W

- Thank you for purchasing this Samsung air purifier.
- Before operating this unit, please read this user manual carefully and retain it for future reference.

SAMSUNG



Contents

Safety Information	3
Safety Information	3
Package Content	7
Accessories	7
At a Glance	8
Front side / Rear side	8
Buttons / Display	9
Connecting the power adapter / Disconnecting the power adapter	10
Removing the filters	11
Assembling the filters	13
Operation Features	16
Turning the power on/off / Controlling the fan speed	16
Wind-Free mode / Sleep mode / Lock	17
Clearing the filter replacement reminder	18
Checking the air quality	19
Using Combined Air Purifiers / Combining air purifiers	21
Decombining air purifiers	22
Precautions when using combined air purifiers	23
Cleaning and Maintenance	25
Cleaning the air purifier exterior	25
Cleaning and drying the filters	26
SmartThings app	27
SmartThings app	27
Appendix	31
Before Requesting Service	31

Proper sizing and installation of equipment is critical to achieve optimal performance. Ask your contractor for details or visit www.energystar.gov.



Qualified model list :
AX300T9080S / AX300T9080W

Safety Information

READ AND SAVE THESE INSTRUCTIONS

California Proposition 65 Warning (US)

 **WARNING:** Cancer and Reproductive Harm - www.P65Warnings.ca.gov.





These safety precautions are for owner's safety and preventions of property damage. Therefore, please read this manual thoroughly before using your product.

WARNING

Hazards or unsafe practices that may result in severe personal injury or death.



CAUTION

Hazards or unsafe practices that may result in minor personal injury or property damage.

-  Follow directions.
-  Do NOT attempt.
-  Make sure the machine is grounded to prevent electric shock.
-  Disconnect from the power source.
-  Do NOT disassemble.

FOR INSTALLATION

WARNING

-  **Only connect to a socket that can provide the rated power supply. Do not use the socket with other products. Do not extend the power cord.**
 - Using a multi-socket with other products or extending the power cord may cause electric shock or fire.
 - Using a voltage converter may cause electric shock or fire.
 - Failing to meet the exact voltage, frequency and/or rated current may cause electric shock or fire.
-  **Do not install the air purifier near a heat source and inflammable objects, or in areas that are highly humid or dusty. Avoid exposure to oil, gas, direct sunlight and water.**
 - Follow instructions to avoid electric shock or fire.

CAUTION

-  **When installing the product, make sure that the power plug can be easily removed when needed.**
 - Follow instructions to avoid electric shock or fire due to electrical leakage.
- Install the product on a solid flat ground.**
- Follow instructions to avoid excessive vibration, noise and operational issues thereof.

Safety Information

- ❗ **Keep a safe distance from surrounding objects.**
 - Clear space from each side: at least 24 inches and the rear: at least 10 inches
 - The space is necessary to ensure efficient air intake and proper purification.
 - Make sure that the inlet and outlet are not covered.

Make sure that the power cord is not pressed under the product.

- Follow instructions to avoid electric shock or fire.

FOR POWER SUPPLY

⚠️ WARNING

- ❗ **Use a dry cloth to wipe the power plug and the contact area to keep them free from dust, water and other undesirable substances.**

- Follow instructions to avoid electric shock or fire.

Check the position of the power plug when you connect it to a socket.

- Having the cord hanging from above the plug may damage the wires inside, which can lead to electric shock or fire.

Please contact your local Samsung Service Center if the power plug or cord is damaged.

- ⊘ **Make sure that the power plug is securely fitted in the socket. Do not use it when the plug or cord is damaged.**

- Follow instructions to avoid electric shock or fire.

When you disconnect the power cord, pull it by the plug. Do not pull the cord itself.

- Follow instructions to avoid electric shock or fire.

Do not fold, pull out, twist or tie the power cord. Do not hang it over a metal object or place a heavy object on it. Do not put the cord between objects or behind the air purifier.

- Follow instructions to avoid electric shock or fire.

⚠️ CAUTION

- ⚡ **Remove the power plug of your air purifier when it is not used for a period of time and during a thunderstorm.**

- Follow instructions to avoid electric shock or fire.

Product installation must be handled by official Samsung service personnel or a certified local technician to avoid power cord or plug damage, which can be dangerous.

Disconnect the air purifier from the power source before cleaning or repairing.



FOR USING



WARNING



If the product is exposed to water, immediately disconnect it from the power source and contact your local Samsung Service Center.

- Follow instructions to avoid electric shock or fire.

If you notice a noise, burning smell or smoke from the product, immediately stop using it and contact your local Samsung Service Center.

- Follow instructions to avoid electric shock or fire.

In the event of a gas leak in proximity of the air purifier, do not touch it or attempt to unplug it. Immediately ventilate the room and contact your provider or a certified technician for advice.

- Do not turn the ventilation fan on.
- A spark can cause an explosion or fire.

Do not pull out the power plug while operating the air purifier.

- This may cause a spark when reconnecting the plug, which can lead to an explosion or fire.

Please contact your local Samsung Service Center when you require repair service.

- Follow instructions to avoid malfunction, water leakage, electric shock or fire.



Do not handle the power plug with wet hands.

- Follow instructions to avoid electric shock or fire.

Do not strike the product with excessive force or pull or press the front panel forcefully.

- Failure to do so may result in fire, a product malfunction, injury, noise or deformation.

Store the plastic package away from children or discard it according to the law.

- Follow instructions to protect children from a risk of suffocation.

Do not insert your finger or other objects into the air inlet or outlet.

- Take special care to protect children from injury.
- Take special care not to injure your fingers by putting them between the front panel and the product when the front panel is closing.

Do not place an object near the air purifier as children may use them to climb onto the product.

- Follow instructions to avoid injury from a tip-over or fall.

If the power plug area has contacted water, completely dry it before using the air purifier again.

- Follow instructions to avoid electric shock or fire.

Do not insert a metal object and similar items inside the air purifier.

- Follow instructions to avoid electric shock or injury.

Do not place a heavy object on the air purifier.

- Follow instructions to avoid malfunction or noise.

To reduce the risk of fire or electric shock, do not use this fan with any solid-state speed control device.

Not suitable for use with solid-state speed controls.

English 5



Safety Information

 If any of the electric components inside the air purifier has contacted liquid or water, disconnect the product from the power source and contact your local Samsung Service Center.

- Follow instructions to avoid electric shock or fire.

 Do NOT attempt to repair or modify the product.

- Use only the standard rated fuse.
- Follow instructions to avoid electric shock, fire, malfunction or injury.

 **CAUTION**

 Keep your air purifier at least 7 feet away from a TV or other audio/visual media.

- They can be affected by video or audio noise.

Secure enough space around the air purifier when operating.

- Clear space from each side: at least 24 inches and the rear: at least 10 inches.
- Your air purifier is designed to take in air through the rear inlet for purification. Keep the area around the inlet clear and make sure that both the inlet and outlet are not covered by any obstacles including curtains.

 Do not step on the product or place other objects on it (laundry, candles, burning cigarettes, plates, medicine, metal items, air fresheners, etc.).

- Follow instructions to avoid electric shock, fire, malfunction or injury.

Do not tilt or flip the air purifier while the power plug is connected to the socket.

- Follow instructions to avoid malfunction or fire.

Do not use bug repellent or other spray products on the air purifier.

- They can be harmful and may cause electric shock, fire or malfunction.

Do not submerge the air purifier.

- Follow instructions to avoid malfunction.

Do not handle the product with wet hands.

- Follow instructions to avoid electric shock.

This appliance can be used by children aged from 8 years and above and persons with reduced physical, sensory or mental capabilities or lack of experience and knowledge if they have been given supervision or instruction concerning use of the appliance in a safe way and understand the hazards involved. Children shall not play with the appliance.

Cleaning and user maintenance shall not be made by children without supervision.

FOR CLEANING

 **WARNING**

 Do not apply water, benzene, thinner, alcohol, acetone or similar substances directly on the product.

- Follow instructions to avoid product discoloration or deformation, electric shock or fire.

Disconnect the product from the power source when cleaning. Wait for the fan to completely stop before cleaning.

- Follow instructions to avoid electric shock or fire.

 **CAUTION**

 Be sure to disconnect the power plug from the socket before cleaning the product.

Package Content

Accessories

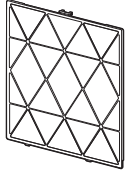

Pre-filter
1 EA

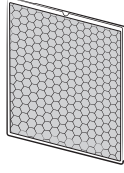

Deodorization filter¹⁾
1 EA

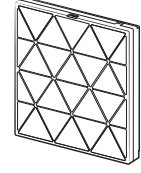

Dust collecting filter¹⁾
1 EA

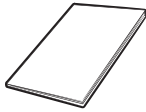

User manual
1 EA

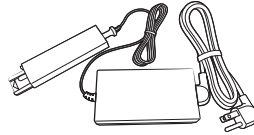

Power adapter
1 EA

¹⁾ The deodorization filter and Dust collecting filter are replacement filters. They cannot be used again by washing them with water.

NOTE

- After replacing a replacement filter with a new one, dispose of the old one in a waste bag as general waste.
- Use only Samsung authorized filters. Use of non-authorized filters may void product warranty.
 - When purchasing a replacement filter, be sure to check whether it is the same type of filter.

At a Glance

Front side

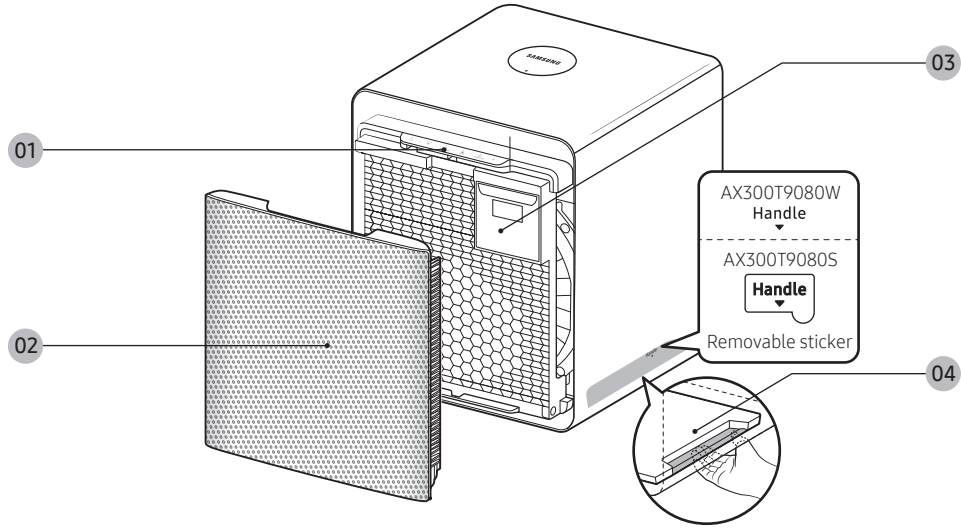

- 01 Buttons
- 02 Air outlet / Front panel

- 03 Display
- 04 Handle (both bottom sides)

Rear side

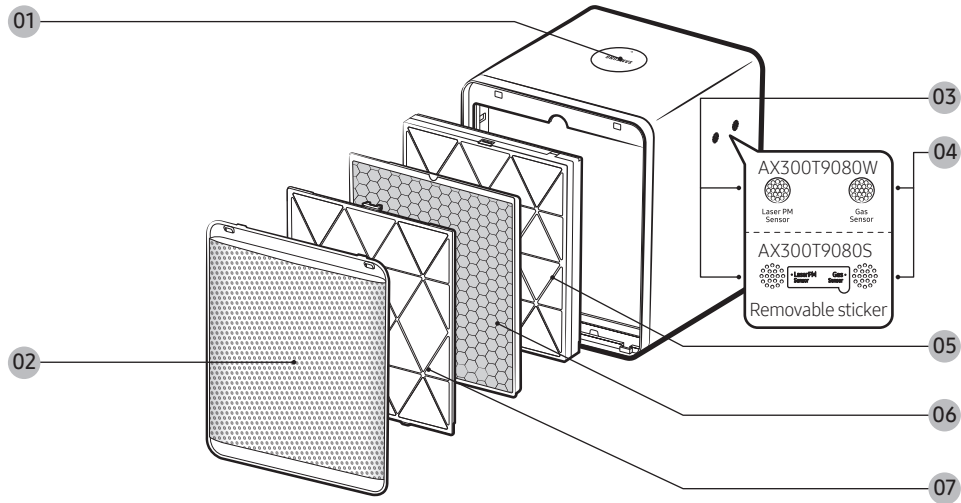

- 01 Module connector
- 02 Air inlet / Rear panel
- 03 Laser PM sensor
- 04 Gas sensor

- 05 Dust collecting filter
- 06 Deodorization filter
- 07 Pre-filter



Buttons

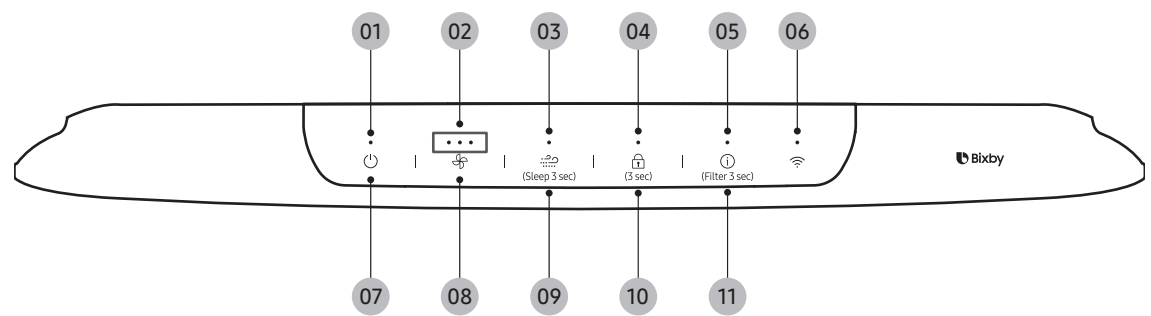

- 01 Power indicator
- 02 Fan speed indicator
- 03 Wind-free mode indicator
- 04 Lock mode indicator
- 05 Filter replacement indicator
- 06 Wi-Fi function indicator
- 07 Power button
- 08 Fan speed button
- 09 Wind-free mode / Sleep mode button
- 10 Lock button
- 11 Air quality / Filter reset button

Bixby is the name of a Samsung AI solution and allows you to control the product with voice. To use the voice recognition function, you must connect the SmartThings app on your smartphone to the product. If the product does not support voice recognition directly, you can only control some functions using Bixby on your Samsung smartphone.

At a Glance

Display

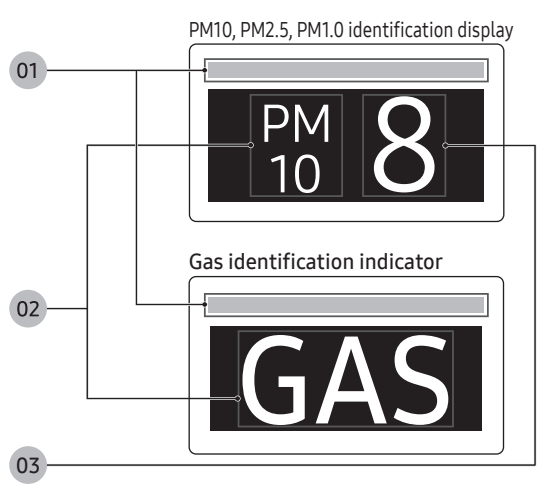

- 01 PM10, PM2.5, PM1.0, GAS cleanliness color display
 - 02 PM10, PM2.5, PM1.0, GAS status display
 - 03 PM10, PM2.5, PM1.0 concentration display
- NOTE**
- PM10: Dust in the air with a diameter of 10 μm or less
 - Fine particles with about 1/5 of the diameter of a human hair
 - PM2.5: Dust in the air with a diameter of 2.5 μm or less
 - Fine particles with about 1/20 of the diameter of a human hair
 - PM1.0: Dust in the air with a diameter of 1.0 μm or less
 - Fine particles with about 1/50 of the diameter of a human hair
- * Diameter of a human hair: 50–70 μm



At a Glance

Connecting the power adapter

Before using the air purifier, connect the power adapter to the product.

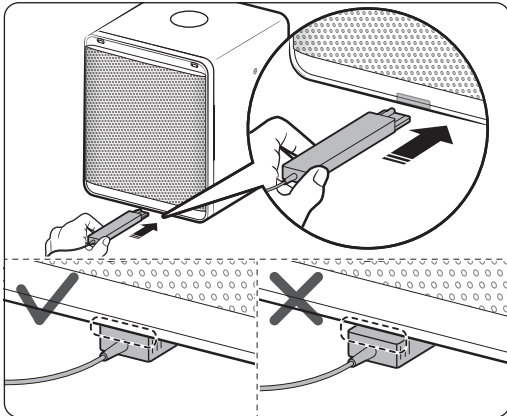

Check the vertical direction of the power adapter, and then connect it to the port on the bottom rear of the product.

- Slide the power adapter all the way in until it clicks into place.

NOTE

- The product will not work if you do not slide the power adapter all the way in.

Caution

- Make sure that no damage is caused to the adapter.
- Do not use a damaged adapter. Follow instructions to avoid electric shock or fire.

Disconnecting the power adapter

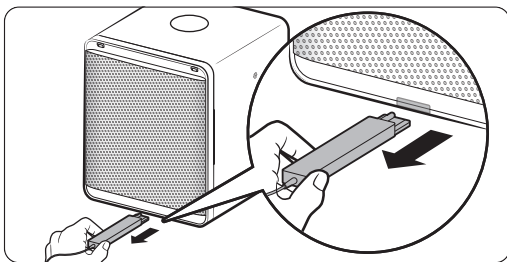

Disconnect the power adapter from the product as shown in the figure.

- Before combining or decombining products, be sure to disconnect their power adapters.

Caution

- Do not pull on the power adapter cord.



Removing the filters

When using a replacement filter for the first time or replacing it with a new one, be sure to remove the vinyl packaging.

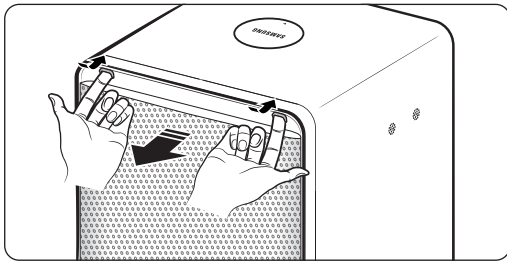

STEP 1 Open the rear panel.

- Put your fingers in both grooves at the top of the rear panel, and then pull it forward.

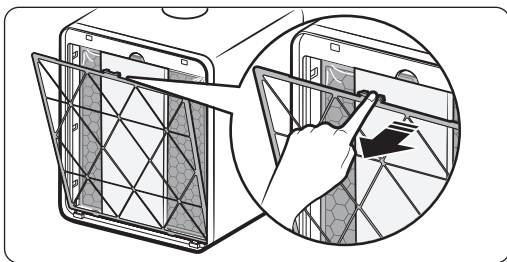

STEP 2 Remove the pre-filter.

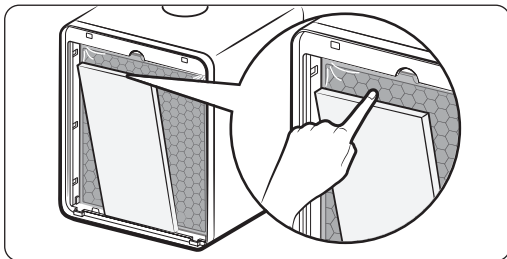

STEP 3 Remove and discard the protective foam.

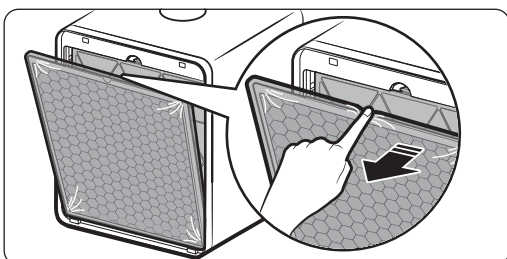

STEP 4 Remove the deodorization filter.



At a Glance

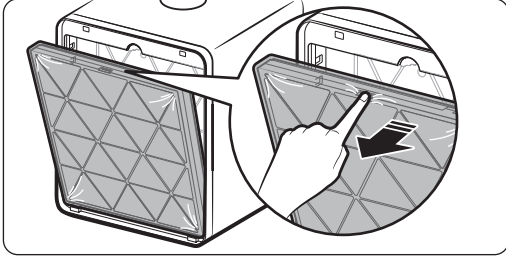

STEP 5 Remove the dust collecting filter.

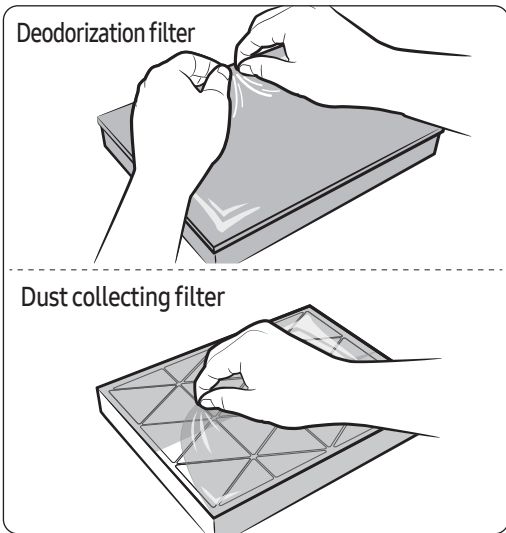

STEP 6 Remove the vinyl packaging from the deodorization filter and the dust collecting filter.

- And also, remove the black cloth inside the vinyl packaging of the deodorization filter.



Assembling the filters

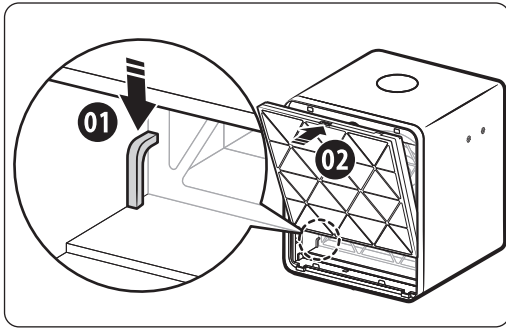

STEP 1 Insert the dust collecting filter.

- Let the filters sit inside the grooves at the bottom.
- Check direction of the filters before inserting.

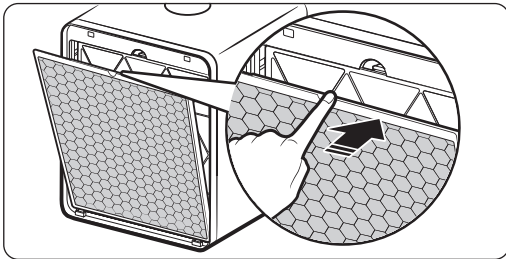

STEP 2 Insert the deodorization filter.

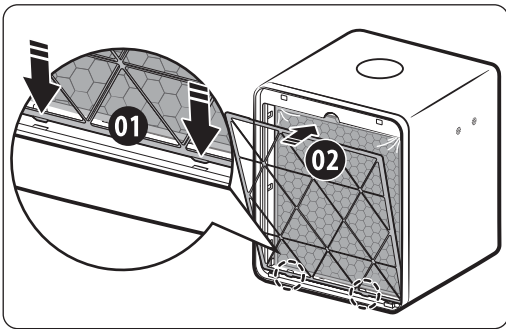

STEP 3 Insert the pre-filter.

- Insert the hooks on the filter into the grooves on the bottom of the product, then slightly push against the unit.

At a Glance

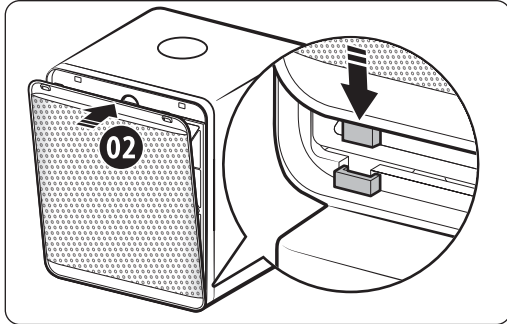

STEP 5 Close the rear panel.

- Insert the hook on the panel first into the groove at the bottom of the unit, then slightly push until it clicks.

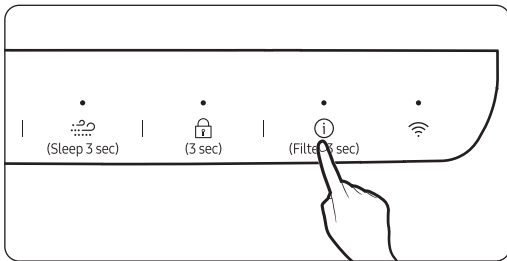

STEP 6 After replacing the filters, reset the filter alarm.

- Press and hold the [] button for 3 seconds or more.

NOTE

- When the filters need to be replaced, filter alarm lights up in red with beeping sound.
In case of filter replacement, replace the filters with new ones, then reset the filter replacement reminder.
- When the filters are saturated with surrounding odors and thus smell, replace them with new ones, and then reset the filter replacement reminder.

NOTE

- Keep the windows and doors closed whenever you can while the product is running.
 - Ventilate the air regularly to avoid high concentration of carbon dioxide when you keep the room enclosed for a duration of time. When the filters have a weak smell, regular ventilation also reduces the smell.
- Remove the protective vinyl that covers the buttons after the product is turned on and the front panel is fully opened.

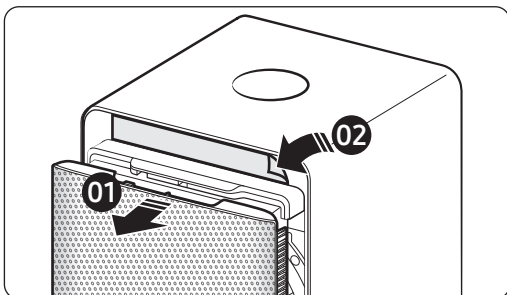



Using the filters

- If you operate the product without the filters, the purification effect is lowered, and the air flow sound may be abnormally loud during operation.
- You may notice a subtle odor from fresh filters when using your newly purchased air purifier for the first time.
 - which will disappear naturally in about a day.
- The filter cleaning and replacement cycles may vary depending on the operating environment.
- The filter replacement reminder takes into account the product uptime and lights up when the filters reach the maximum operation time. The frequency of filter cleaning and replacement may vary depending on the operating environment.
- The replacement cycles of the deodorization filter and the dust collecting filter are from 6 months to 1 year when the product operates 24 hours every day. Filter lifespan is related to the air quality in the operating environment. The more polluted the indoor air, the shorter the filter lifespan.
- The Filter replacement reminder will light up when the filter lifespan has been reached.
 - User should replace filters, even if the replacement reminder did not light up, if they are too dirty, causing fan to slow down, or have picked up a smell that will not go away.
- If you operate the product after it has been unused for 2 weeks or more, or if there is a smell, run a cleaning operation by running the product in a well-ventilated space at the High fan speed for 4 hours or more, or dry the filters in the sunlight for 4 hours or more. This can help remove odors from the filters.
- If the filters smell when you operate the product, it means that it is time to replace them because they are saturated with surrounding odors. Replace the filters with new ones.
 - The filters are a consumable part, and will not be replaced free of charge even during the free warranty period.
- To purchase a new replacement filters, contact a local Samsung Service Center or visit www.samsung.com on the web.

Deodorization filter

The deodorization filter effectively removes daily odors such as bathroom and food odors.

- In a room with persisting odors, using the product after ventilating the room first allows more effective odor control.
 - Using air purifier while cooking food with strong odor, it may cause smell from deodorization filter, or reduced filter lifespan and shortened replacement terms.
- Carbon monoxide (CO) is a major harmful gas that cannot be removed by the deodorization filter and is usually introduced from outside.
- Do not wash deodorization filter while still in the Air Purifier. Do not place Air Purifier in water or in an area where water could spill on the unit.

Dust collecting filter

The dust collecting filter removes fine dust, cigarette smoke particles, and more from the air.

- Do not wash dust collecting filter while still in the Air Purifier. Do not place Air Purifier in water or in an area where water could spill on the unit.





Operation Features

If you hear a chime sound when you connect the power cord, it means that the power is normally connected.

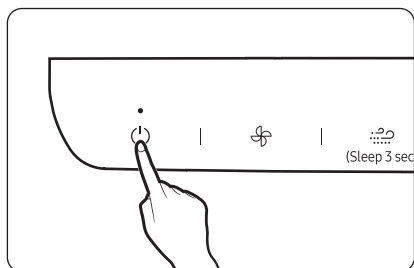

Turning the power on/off

- Press the Power button. The air purifier turns on with a notification sound and automatically begins operation.
 - Sensor preparation begins upon startup with a display indication and continues for 12 seconds. The air quality is then indicated by color and the concentration level.
 - Cleanliness color indicator: PM10, PM2.5, PM1.0, GAS
Concentration display: PM10, PM2.5, PM1.0

Sensor loading display



- The product operates with the front panel being open about 30 mm. However, when you turn on the power for only the first time after connecting the power cord, the front panel is opened about 40 mm. Then the front panel is closed by about 10 mm and the product starts to operate.
- When you turn off the power and turn it back on, the product operates at the last fan speed you used.

NOTE

- When the air quality level remains the same for a specific period of time during operation, All indicators and displays except for the cleanliness color indicators turn off and the product enters the Energy saving mode.
(This does not apply when using the product in Sleep mode.)

Controlling the fan speed

Use the button to select the intensity of air flow to purify the indoor air.

- Press the [Fan Speed] button to select the fan speed you want.
 - Each time you press the button, the fan speed changes in the order of Low → Medium → High → Auto → Low.
- In Auto mode, the fan speed is automatically adjusted to the particle and gas pollution levels around it to keep the room clean.
 - When the product operates in the Auto mode for a certain period of time and the indoor air becomes clean, the front panel comes back into the product's body and the operation mode is switched to the "Auto + Energy saving" mode.
 - The Energy saving mode is automatically released when the indoor air becomes bad, or you can cancel it by selecting a fan speed manually.

Fan speed indications

Low	•
Medium	• •
High	• • •
Auto	• • • → • • • → • • •



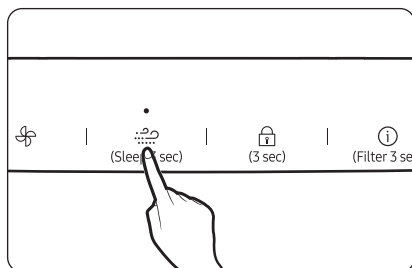



Wind-Free mode

Use the Wind-Free mode to purify the air with a gentle wind. When you start the Wind-Free mode, the front panel comes back into the product's body.

- If you cancel the Wind-Free mode while it is running, the product operates in the previous mode.

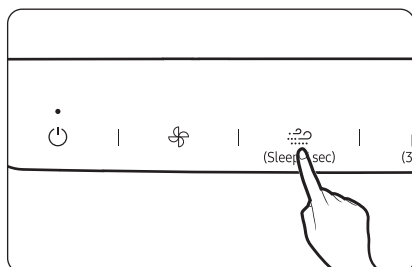

Cancel

- Press the [] or [] button.



Sleep mode

Sleep mode provides a clean, quiet and comfortable room for a good night's sleep.

- Press and hold the [] button for 3 seconds or more to operate the product in the Sleep mode.
- Press and hold the [] button for 3 seconds or more to turn the Sleep mode on or off.
- In the Sleep mode, the front panel is closed, the front display is turned off, and only the power indicator lights up.
- Changing the fan speed when Sleep mode has been active for 10 seconds or more will cancel the mode and the sensor loading display will appear. (See 'Sensor loading display' on page 16.)

Cancel

- Press and hold the [] button for 3 seconds or more, or press the [] button.

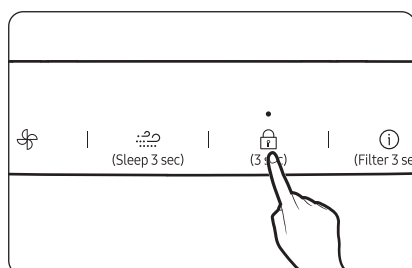

Lock

Use this feature to lock all buttons and prevent unintended button operation, especially by children.

- Press and hold the [] button for more than 3 seconds. A "Ding" sound is emitted, and all buttons are locked.
- All buttons become inaccessible while Lock feature is on.

Cancel

- Press and hold the [] button for 3 seconds or more. The feature is released after a beep.



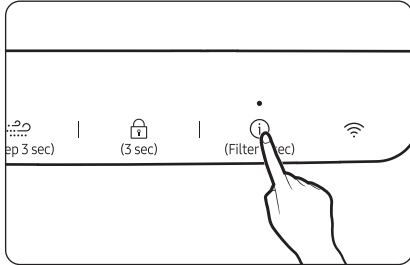

Operation Features



Clearing the filter replacement reminder

Use the Filter Reset function to reset the filter replacement reminder after replacing the deodorization filter or the dust collecting filters. The product automatically tells you when to replace them.

- If you hear a beep and the filter replacement indicator lights up in red while the product is running, replace the replacement filters with new ones. Then press and hold the [] button for 3 seconds or more to reset the filter replacement reminder. A "D-D-Ring" sound is emitted, and the filter replacement indicator blinks twice and disappears.
- If filter has been replaced and filter replacement indicator lights up in red, press and hold the [] for 3 seconds or more to reset the filter replacement reminder.

Caution

- If you reset the filter replacement reminder when the filters are not replaced with new ones or when no filters are installed in the product, filter replacement reminders may not be displayed normally.

NOTE

- If the filters need to be replaced, the alert 'Filter' is shown on the display for 10 seconds when the power is turned on.



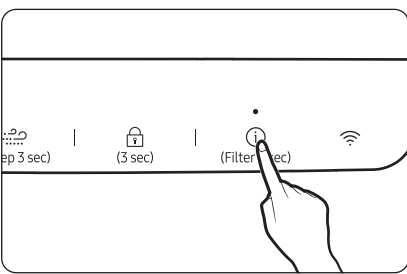
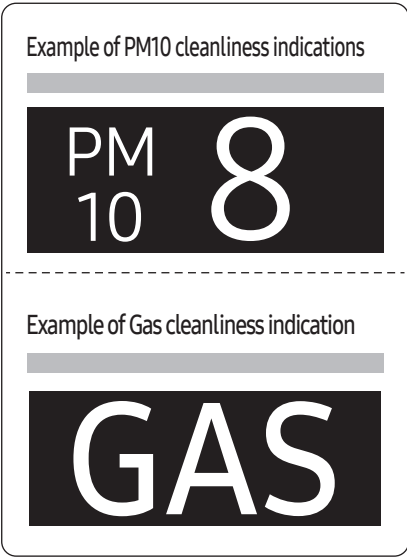

Checking the air quality

Use the Air quality function to display the cleanliness color indication for PM10, PM2.5, PM1.0, or GAS and the concentration for PM10, PM2.5, or PM1.0 on the display.

- By default, both the cleanliness color indicator and the concentration display for PM10, PM2.5, and PM1.0 display the PM10 cleanliness status.
- Each time you press the [Filter 3 sec] button when the product is running, cleanliness information is displayed in the order of PM10 → PM2.5 → PM1.0 → GAS. PM2.5 cleanliness, PM1.0 cleanliness, and GAS cleanliness are each displayed for 10 seconds if there is no user input, and then PM10 cleanliness automatically continues to be displayed.
 - If PM2.5 cleanliness, PM1.0 cleanliness, or GAS cleanliness is worse than PM10 cleanliness, the worst value is displayed. When they are all the same, PM10 cleanliness is displayed.
- Air quality levels

Pollution level		PM10 concentration (µm/m ³)	PM2.5 / PM1.0 concentration (µm/m ³)	Gas pollution level
Very poor	Red	151 and over	76 and over	4
Poor	Yellow	81 - 150	36 - 75	3
Moderate	Green	31 - 80	16 - 35	2
Good	Blue	30 and below	15 and below	1

- PM10, PM2.5 and PM1.0 measurement will be displayed in numbers 05 – 999.

Operation Features

NOTE

- When the air quality level remains the same for a specific period of time during operation, All indicators and displays except for the cleanliness color indicators turn off and the product enters the Energy saving mode.
(This does not apply when using the product in Sleep mode.)
- The dust concentration may vary depending on the environmental conditions (for example, when the product is near a construction site, road, or fabric sofa, or when a vacuum cleaner is used or bedding and clothes are arranged near the product, etc.).
- The following conditions may cause temporarily high readings of PM level:
 - When the product is used:
 - near fur rugs or near pet or animal enclosures, clothing stores, or other places prone to high humidity, smoke or other heavy dust pollution.
 - When humidifiers, electric pressure cookers, sprayers and such are being used in the same room.
 - When the product is used where there is inflow of outside air with dust or other types of air pollution. (e.g. proximity to the building's HVAC or ventilation systems, or loose window frames)
- The gas pollution reading can be affected by odorous household items such as air fresheners, deodorants and detergents.
- If you are using more than one air purifier in the same room, the dust concentration reading on each unit may not be same as they affect air circulation. The dust concentration reading may vary depending on the sensor or product being used.
- If there is no change in the intensity of gas (odor), it may not be reflected in the gas pollution reading even though you can clearly smell it.
- PM levels on the display may differ from the official forecasts.
- Nearby electromagnetic waves or electrical noises may cause temporarily high readings of PM level.
- If PM10 cleanliness continues to be at the Very Poor level for a specific period of time, the alert 'Alert' is shown on the display. If you see the alert, check the surroundings.
The alert is removed when the product is turned off or set to the Sleep mode. If there is any button input, the alert is not displayed for the next 10 minutes.





Using Combined Air Purifiers

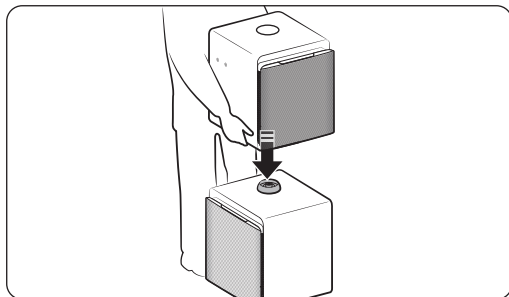

- When combined, the top product will operate both units together. The bottom unit can only be turned on or off, but operational control is ceded to the top unit.
 - In combined air purifiers, you can operate them using only the top product. The bottom product operates in the same way as the top product. However, when the top product is operating, you can turn just the bottom product on or off.
 - The display lights up only on the top product, and only the power status is visible on the bottom product.
 - You can rotate the air outlet of the product at the top in 360 degrees.
- When combining and decomposing products, be sure to turn off their powers and use their handles.
- Some functions may not be supported if this product is combined with a model released previously.

Combining air purifiers

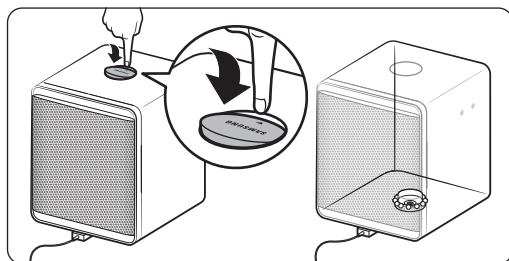

STEP1 Open the module connector on the bottom product.

- Push and rotate the module connector on the product that will be located at the bottom.

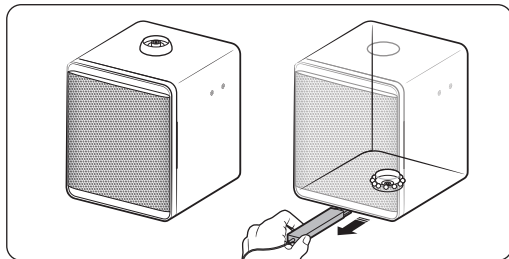

STEP2 Disconnect the power from the top product.

- Disconnect the power adapter from the product that will be located at the top.
 - In combined products, the power is supplied through the bottom product. Keep the disconnected power adapter in a separate place.

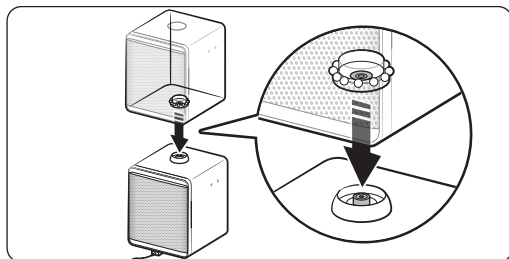

STEP3 Combine the top and bottom products.

- Align the product that will be located at the top with the module connector on the top of the product that will be located at the bottom, and assemble both products.

⚠ Caution

- If the products are assembled without being aligned with the module connector, it may cause product falling, product damage, or personal injury.

Using Combined Air Purifiers

Decombining air purifiers

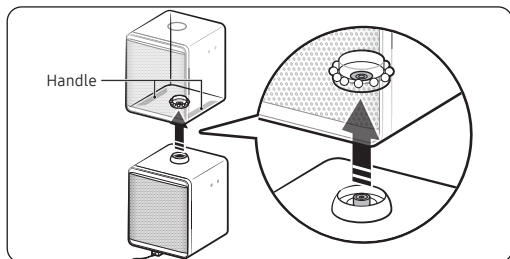

STEP1 Remove the top product.

- Hold the bottom handles of the top product and remove it.

⚠ Caution

- Be sure to check whether the bottom product is installed stably.
- When moving the top product, hold its handles and be careful not to drop it.

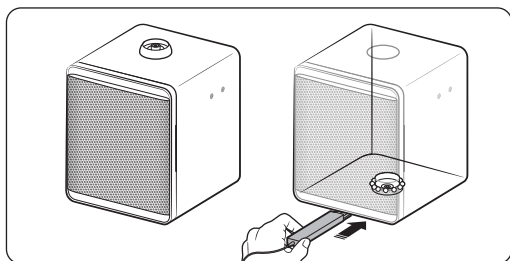

STEP2 Connecting the power to the decombined product.

- Connect the power adapter to the decombined top product.

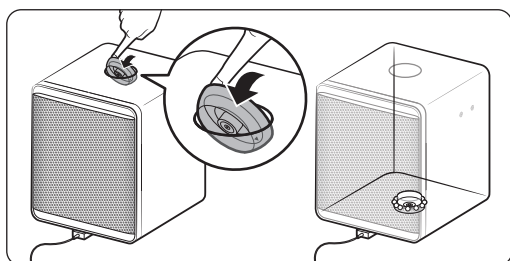

STEP3 Close the module connector on the bottom product.

- Rotate the module connector on the top of the bottom product.

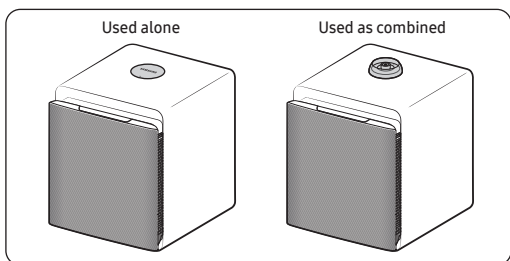

📄 NOTE

- Before using a product alone, be sure to rotate the module connector so that it is placed at its original position.

Precautions when using combined air purifiers

⚠ Caution

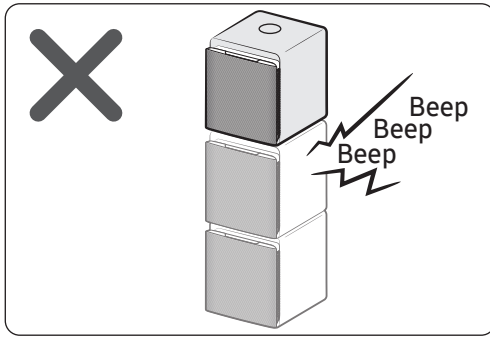

You can combine only two products.

- If three or more products are combined, they do not operate and a "beep beep beep" sound is emitted continuously. The products may fall down and cause product damage or personal injury.

📄 NOTE

- If three or more products are combined, the alert "2 Only" is shown on the display.

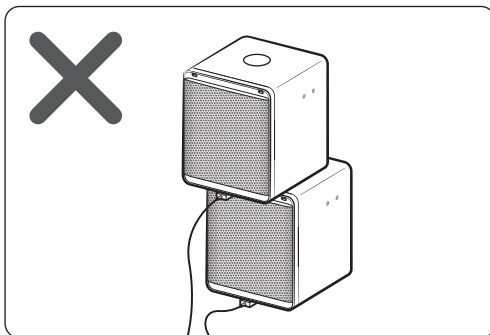

Do not stack products in two stages and apply the power to each one. When stacking products in two stages, be sure to combine them using the module connector.

- Failure to do so may result in product falling or damage.

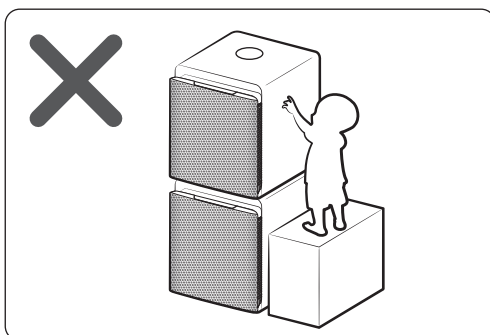

Do not place an object near the combined products that makes it possible for children to climb onto them.

- Failure to do so may result in product falling or damage, and children may fall and get hurt.

Using Combined Air Purifiers

⚠ Caution

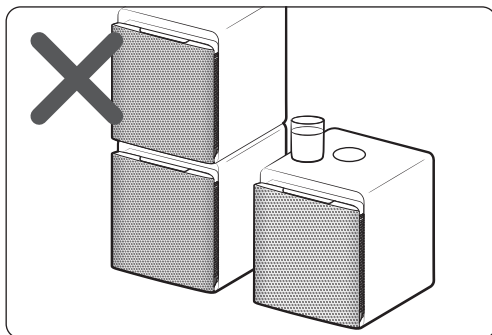

Do not place liquids on the products when each product is used alone or when combined products are used.

- Liquids that enter the product may cause product malfunction and filter contamination.

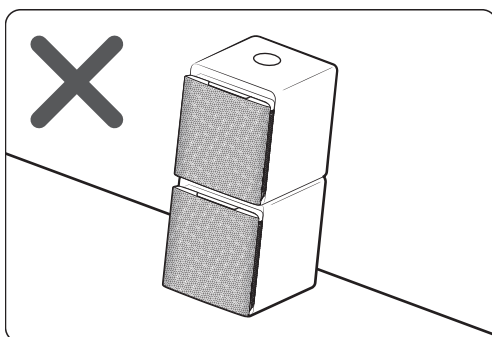

Do not combine products or use combined products on a floor that is inclined or not flat.

- Even a small impact may cause the product to fall.

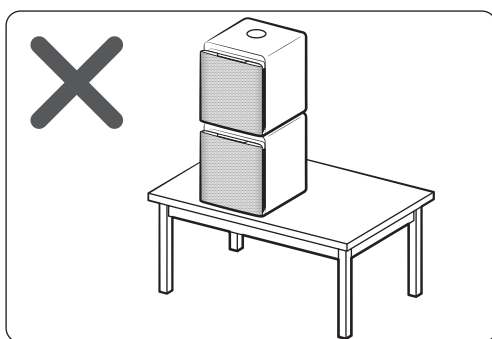

Do not combine products or use combined products on a table.

When combining products, be sure to put them on the floor and combine them using the module connector.

- Failure to do so may result in product falling or damage, or injury.

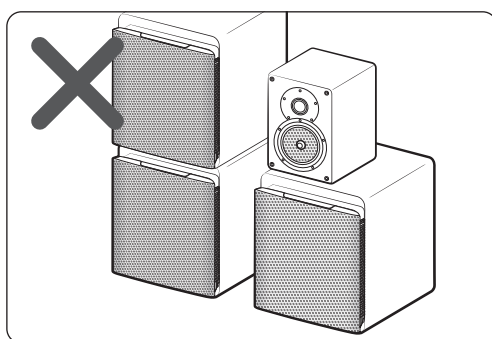

Do not place objects on the products when each product is used alone or when combined products are used.

- Failure to do so may result in product discoloration or deformation due to adhesives and rubbers.

Cleaning and Maintenance

⚠ Be sure to disconnect the power plug from the socket before cleaning the product.

Cleaning the air purifier exterior

- Dampen a soft cloth with lukewarm water and wring it out, and then wipe the product exterior with it.
- Wipe the grooves on the front and rear panels with a cotton swab.
- If it is too hard to clean the dust from the front or rear panel, remove the panel and wash it with water.

⚠ Caution

- Do not wipe the product with an alkaline detergent.
- Do not wipe the product surface with sulphuric acid, hydrochloric acid, or organic solvents (thinner, kerosene, acetone, etc.). Do not attach a sticker to the product. Failure to do so may result in damage to the product surface.

Cleaning the sensors

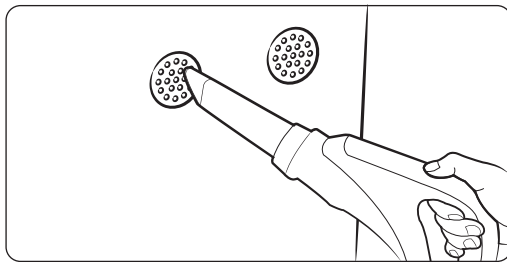

- If there is dust or foreign substance on a sensor, use a vacuum cleaner to clean the sensor and its surrounding.

⚠ Caution

- Do not put any dust into the sensor openings.

Cleaning and drying the front panel

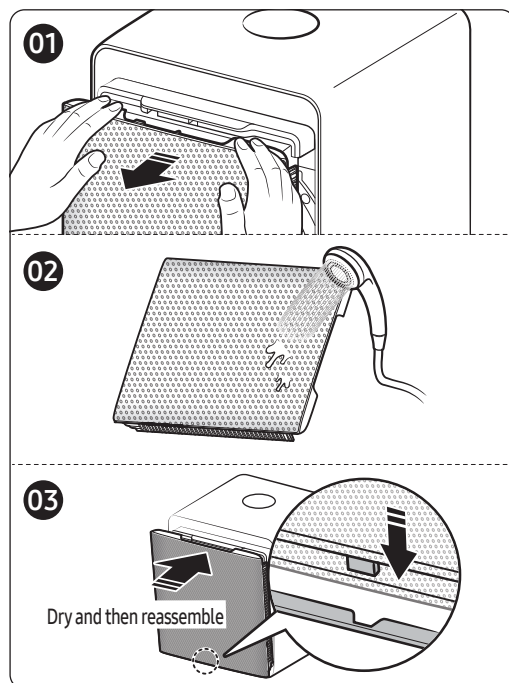

STEP1 Remove the front panel.

- Hold and pull the front panel forward until it is removed.
 - If you have difficulty in removing the front panel because it is closed, turn on the power, unplug the power cord while the front panel is open, and then remove the front panel.

STEP2 Clean and dry the front panel.

- Clean any dirt or foreign substance on the front panel with water or a soft cloth.
- After cleaning with water, thoroughly dry the front panel before reassembling it to the product.

STEP3 Reassemble the front panel.

- Insert the hook at the bottom of the front panel into the bottom fixing groove, and then press the top center of the front panel so that it is assembled to the product.
 - If the front panel is open, connect the power cord and turn on the product so that the product operates and the front panel returns to its closed position.

Cleaning and Maintenance

Cleaning and drying the filters

NOTE

- For how to remove or assemble the filters, see pages 11 and 13.

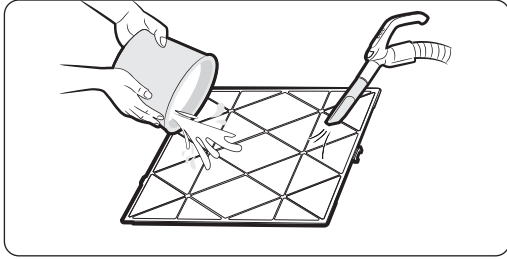

Cleaning the pre-filter

- If you can see dust accumulations, remove large dust first with a vacuum cleaner, and then rinse the filter with lukewarm water.
 - Cleaning interval: 2 weeks (when using the product 24 hours every day)

Caution

- When cleaning the pre-filter, rubbing with a brush or a similar tool may damage the superfine fibres.

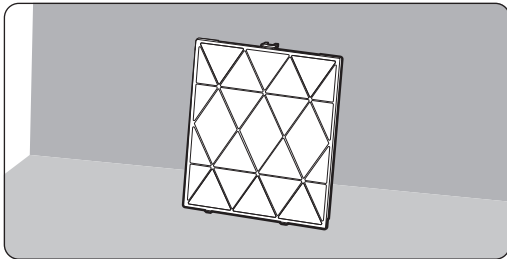

Drying the filters

- Keep the filters in the shade until completely dry and away from direct sunlight.

SmartThings app

To use the SmartThings app, connect the product to the network in the sequence described below. The images shown may differ depending on your smartphone model, OS version and manufacturer. You need to set up the Wi-Fi access point only when connecting the product to a Wi-Fi network. Once the product is connected, you can use the SmartThings app via Wi-Fi, 3G, LTE or more wireless networks. If the WiFi disconnects, please follow the instructions on the Samsung SmartThings app via your mobile device or tablet.

1 Checking the power connections

Check if the power is connected to the product and the access point.

2 Setting up and connecting to a Wi-Fi access point using your smartphone

1 To connect the product to a Wi-Fi network, turn on Wi-Fi at "Settings > Wi-Fi", and then select the access point to connect to

- Only alphanumeric characters are supported for wireless access point names (SSIDs). If an SSID has a special character, rename it before connecting to it.
- This product supports only Wi-Fi 2.4 GHz.



2 Turning off "Switch to mobile data" at "Settings > Wi-Fi" on your Smartphone

- If "Switch to mobile data" or "Adaptive Wi-Fi" is turned on, you cannot connect to the network. Be sure to turn off these functions before connecting to the network.

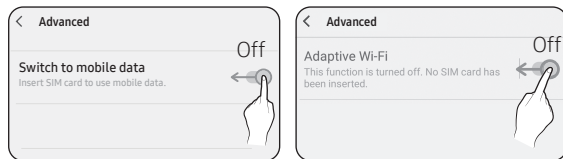

NOTE

- The setup may differ depending on your smartphone model, OS version and manufacturer.

3 Checking the Internet connectivity

- After connecting to Wi-Fi, check that your smartphone is connected to the Internet.

NOTE

- A firewall may prevent your smartphone from connecting to the Internet. Contact your Internet service provider for troubleshooting.

3 Downloading the SmartThings app and registering your Samsung account

1 Downloading the SmartThings app

- Search for "SmartThings" on Play Store or App Store, and download the SmartThings app to your smartphone.
- If the SmartThings app is already installed on your smartphone, update it to the latest version.



NOTE

- For tablets that are not supported by the SmartThings app and the smart phones that have an OS version earlier than the recommended versions, the SmartThings app may not be found.
 - Android OS 6.0 or later (with at least 2 GB RAM) is recommended.
 - Supported screen resolutions: 1280 x 720 (HD), 1920 x 1080 (FHD), 2560 x 1440 (WQHD)
- The SmartThings app is not compatible with some Apple devices including iPad and some smartphones.
 - iPhone 6 or later with iOS 10.0 or later is supported.
 - Supported screen resolutions: 1334x750, 1920x1080
- The SmartThings app may change without prior notice to improve product usability and performance.

SmartThings app

2 Registering your Samsung account

- A Samsung account is required to use the SmartThings app. To create your Samsung account and log in to your account, follow the instructions displayed on the SmartThings app. You do not need to install an additional app.

NOTE

- If you already have a Samsung account, log in to the account. If you have a smartphone that is a Samsung device and you have a Samsung account, your smartphone is automatically logged in to your account.
- If you log in from a smartphone produced for another country, you need to log in with its country code when you create your Samsung account, and the SmartThings app may not be used on some smartphones.

4 Connecting the SmartThings app to your product

1 Selecting the product to connect to

- 1) Start the SmartThings app about one minute after turning on the product to connect to.
- 2) After the SmartThings app is started, select 'ADD NOW' when a pop-up window saying that a product to connect to is found appears.

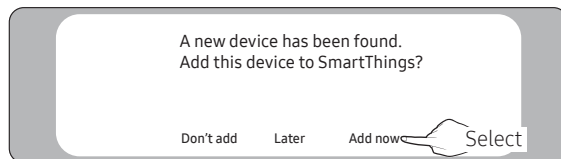

- 3) If the pop-up window does not appear, select "+", and then "Add Device."

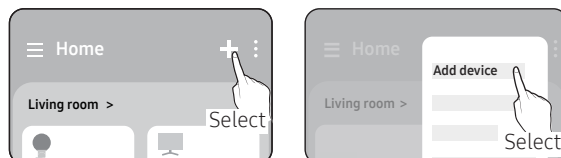

You can add a product you want to connect to by selecting it manually or by selecting "Scan".

- Select manually: Samsung > Air purifier
- Scan: [Air purifier] Samsung

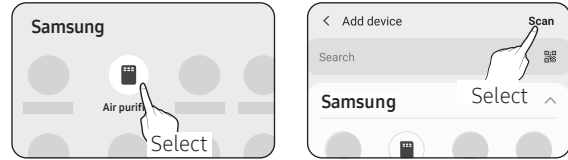

2 Connecting the SmartThings app to your product

- Follow the instructions displayed on the SmartThings app to connect to your product.
- For information on how to use the SmartThings app, select the How To menu on the app.

NOTE

- If any pop-window appears on the top of the smartphone while connecting to your product, do not select it.
- If a pop-up window saying that the device is already registered appears during connecting to your product, get permission using "REQUEST PERMISSION" from a user already connected to the product, or create a new account using "REGISTER MY ACCOUNT" to independently connect to the product.
- If a Samsung account-related country error occurs during connecting to your product, log out of your current Samsung account, log in to your previous Samsung account, and then delete all devices that have been connected previously. Then, log in to your current Samsung account again, and then configure the settings.
- If a failure message appears while adding a device, see "Setting up and connecting to a Wi-Fi access point using your smartphone" on page 27. The connection may fail temporarily due to an installation location problem of the access point or other problems.
- If the word "AP" does not disappear from the display, unplug the power cord and plug it in again.



NOTE

- For the security protocols for wireless/wired access points, WPA-PSK and WPA2-PSK are recommended. For the authentication methods, AES is recommended. New Wi-Fi authentication specifications and Wi-Fi non-standard authentication methods are not supported.
- The product supports the IEEE802.11 b/g/n (2.4 GHz) communication protocol. (Samsung recommends IEEE802.11n.)
- If your Internet service provider permanently have registered the MAC address (a unique identification number) of your PC or modem, you may not be able to connect your product to the Internet. Contact your Internet service provider and ask how to connect devices other than your PC (such as an air conditioner and an air purifier) to the Internet.

Open Source Announcement

The software included in this product contains open source software. You may obtain the complete corresponding source code for a period of three years after the last shipment of this product by sending an email to <mailto:oss.request@samsung.com>.

It is also possible to obtain the complete corresponding source code in a physical medium such as a CD-ROM; a minimal charge will be required.

The following URL http://opensource.samsung.com/opensource/SMART_AT_051/seq/0 leads to the download page of the source code made available and open source license information as related to this product. This offer is valid to anyone in receipt of this information.



SmartThings app

Controlling your air purifier with SmartThings app

Smartly control your air purifier using the SmartThings app.

Category	Function	Description
Monitoring	Indoor air quality	Check the indoor air cleanliness. <ul style="list-style-type: none"> • Touch the ⓘ icon to view the PM10 / PM2.5 / PM1.0 levels and gas cleanliness.
Control	Power supply	Turn your air purifier on or off.
	Controlling the fan speed	Select the fan speed you want.
	Timed on/off	Set the timed on/off times. <ul style="list-style-type: none"> • You can set a total of up to 10 timed on/off times. • You cannot set the same time for both of the timed on and timed off times. • While you are setting a timed on/off time, no timed on/off indications are displayed on your air purifier display. • Once you set a timed on/off time, it persists even if you unplug and plug in the power cord of your air purifier.
	Operation functions	Touch the buttons for various additional functions you want to run.
	settings	Check the settings for region, mute, or filters. <ul style="list-style-type: none"> • You can check the filter replacement time and reset the filter replacement reminder using Filter Info. You can also view the information about replacement filters.
	Help	Useful information to help you understand air related information and terms.
	Device information	View or open the version, tutorial, manual, store, self diagnosis, help desk. <ul style="list-style-type: none"> • Some of the options may not be available on your air purifier.

Before Requesting Service

Check the following before requesting service from the Service Center.

Operation

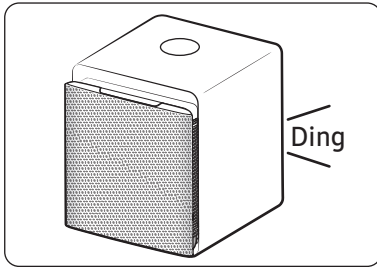

The air purifier does not operate.

- Check the power supply and turn on the air purifier again.
- Make sure that the power plug is plugged in, and then turn on the air purifier again.
If it still does not operate, try a different power outlet.
- Make sure that the rear panel is closed properly. If you hear a "Ding" sound when you open and then close the rear panel, it is closed properly.
- Make sure that the front panel is closed properly.

Sound

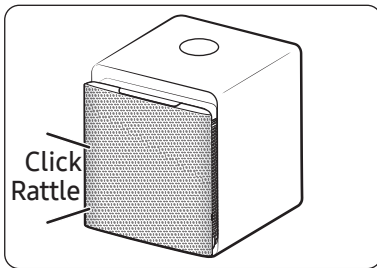

The air purifier makes strange noises.

- If you move the product during operation, it may cause noise. Turn off the power before moving the product.
- When moving the front panel, it may make a "click" or "rattle" sound depending on the operating environment.
 - These sounds are normal motor noises made during zero calibration when moving the front panel.
- When the product is operating, a sensor operation sound, such as a hissing sound, may be emitted.
 - When you sleep or want to rest in a quiet environment, select the Sleep mode.
- When the product operation is ended, the fan may make a hissing sound while it is stopping.

The air purifier is noisy when I sleep.

- Check if the fan speed is High. Change the fan speed to Low, or select the Wind-free mode.

Before Requesting Service

Odors

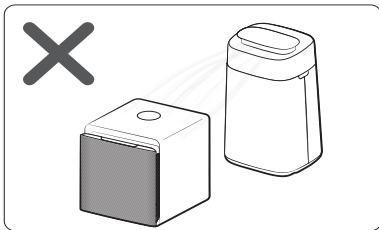
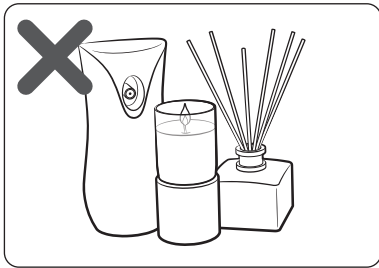
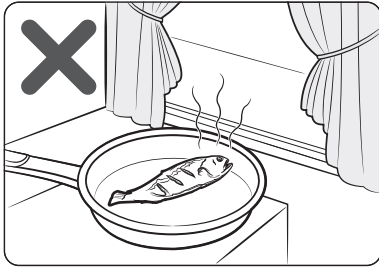

Pollution level

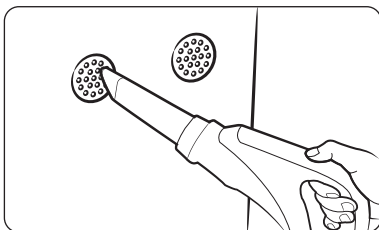

The air purifier smells strange.

- Because the air purifier sucks and circulates indoor air, if you use it in a closed space for a long time, odors generated in your home can saturate the filters.
 - Remove the pre-filter, deodorization filter, and dust collecting filter, and then smell them nearby to check whether odors are saturated to them. If saturated, wash or replace them. You will be charged for replacing filters regardless of the remaining warranty.
 - Open the doors and windows, and then operate the product for 3 to 4 hours.
 - If you grill fish or meat or cook with oil, operate the product after most odors have been removed by ventilation, if possible.
- If you operate the product after using an air freshener, a diffuser, a scented candle, or a cleaning agent, or making interior decoration, or replacing wallpaper, odors may be saturated to the filters, making them smell.
 - Ventilate until the odors are completely removed, and then operate the product.
- If you operate the product continuously in a high humidity environment or an environment where moisture supplied by a humidifier is sucked by the filters, they may smell.
 - If the filters smell due to moisture, dry them well in sunlight before using them again.

The pollution level indicator stays red. (The pollution level indicator does not seem to work)

- Check the sensors for any foreign substances and clean them if necessary.
- In the winter season, installing and operating the product for the first time shortly after delivery may cause the pollution level to reach $999 \mu\text{g}/\text{m}^3$ with the indicator illuminated in red. This is a temporary issue that happens if there is a significant temperature change from outdoor exposure causing condensation inside the unit. In this case, do not be alarmed and continue using the product. The status will be cleared within 1 to 2 hours of operation.
- The gas sensor reacts to changes in the indoor gas pollution level due to cooking or ventilation, causing the indicator to illuminate in red. When this happens, ventilate the room for 1 to 2 hours.
- Disconnect the power plug, then put it back after 1 minute. (To reset the sensor)
- If the indicator color stays in red after you have followed all the provided instructions and solutions, it may be a sensor issue. In this case, please contact your local Samsung Service Center.
- When humidifiers, electric pressure cookers, sprayers and such are being used in the same room, the pollution level may be measured as Poor.



Pollution level

The fan speed does not change when the pollution level changes.

- Set the fan speed to Auto. The fan speed does not change automatically when it is set to Low , Medium, or High or when the Wind-Free or Sleep mode is running.

The PM10, PM2.5, PM1.0 levels do not change from Good (05).

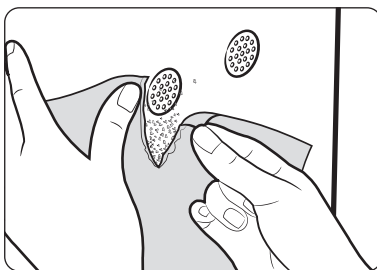

- This may happen when the room is properly sealed and the air is clean.
To check if the sensor is functioning, test it by tearing paper by the sensor and/or rub them to create some dust. This will cause the PM levels to change if the sensor is working properly.
 - Dusting off or cleaning the room may not necessarily cause sensor feedback if the dust particles are bigger than PM10, while they are still filtered and removed from the air.

The PM10, PM2.5, PM1.0 levels the all same.

- When the air is clean, you may not see a difference between the PM10, PM2.5 and PM1.0 levels. To check if the sensor is functioning, test it by tearing paper by the sensor and/or rub them to create some dust. This will cause the PM levels to change if the sensor is working properly.

Display

The filter replacement indicator is always turned on.

- Replace the filters with new ones, and then press and hold the [] button for 3 seconds or more to reset the filter replacement reminder.

Strange indications appear on the display.

- If any of the indications C103, C154, C162, C163 appears, contact a Samsung Service Center.





Memo





Memo





SAMSUNG

QUESTIONS OR COMMENTS?

COUNTRY	CALL	OR VISIT US ONLINE AT
U.S.A - Consumer Electronics - Mobile Phones	1-800-SAMSUNG (726-7864) 1-844-SAM-PAYS (726-7297)	www.samsung.com/us/support
CANADA	1-800-SAMSUNG(726-7864) 1-844-SAM-PAYS (726-7297)	www.samsung.com/ca/support (English) www.samsung.com/ca_fr/support (French)

