

## Universal Kitchen Machines MUM6N10UC / MUM6N11UC



**BOSCH**

**Use and Care Manual  
For Household Use Only**

**Notice d'utilisation et d'entretien  
Usage domestique uniquement**

**Manual de instrucciones y cuidado  
Sólo para uso doméstico**



---

**Use and Care Manual ..... 3**

**READ THIS MANUAL** thoroughly for important safety and operating instructions before using this appliance.

---

**Notice d'utilisation et d'entretien ..... 29**

Avant tout utilisation, **LISEZ ATTENTIVEMENT** ce manuel, vous y trouverez des consignes importantes portant sur la sécurité et le fonctionnement de votre appareil.

---

**Manual de instrucciones y cuidado ..... 56**

**LEA ESTAS INSTRUCCIONES** cuidadosamente por las instrucciones importantes de seguridad y funcionamiento antes de utilizar el electrodoméstico.

---



# IMPORTANT SAFEGUARDS



**READ THIS MANUAL** thoroughly for important safety and operating instructions before using this appliance.

## HOUSEHOLD USE ONLY

**WARNING:** A risk of fire and electrical shock exists in all electrical appliances and may cause personal injury or death.

When using electrical appliances, basic safety precautions should always be followed, including the following:

1. Read all instructions before using the kitchen machine.
2. To protect against risk of electric shock, do not put the drive unit in or under water or other liquid.
3. This appliance is not for use by children.
4. Close supervision is necessary when any appliance is used near children.
5. When children become old enough to operate the appliance, it is the legal responsibility of the parents or legal guardians to ensure that they are instructed in safe practices by qualified persons.
6. Do not leave appliances unattended during operation.
7. Unplug from outlet when not in use, before putting on or taking off parts, and before cleaning.
8. To disconnect: Switch appliance off then remove plug from power supply.
9. Avoid contacting moving parts. Keep hands, hair, clothing, as well as spatulas and other utensils away from whisks, beaters, blades, disc, dough hook and/or other moving parts during operation to reduce the risk of injury to persons, and/or damage to the appliance or its attachments.



## IMPORTANT SAFEGUARDS



10. Do not operate any appliance with a damaged Cord or plug, or alter the appliance malfunctions or is dropped or damaged in any manner. Return appliance to the nearest authorized service facility for examination, repair or electrical or mechanical adjustment.
11. The use of attachments not recommended or sold by the appliance manufacturer may cause fire, electric shock or injury and is therefore prohibited.
12. Do not use outdoors or when standing in a damp area.
13. Do not let Cord hang over edge of table or Counter, or touch hot surfaces.
14. Always operate appliance with covers in place.
15. Blades are sharp. Handle carefully due to risk of injury.
16. Remove beaters from mixing bowl before washing.

### **NOTE:**

ALSO BE SURE TO READ THE WARNINGS AND CAUTIONS THAT ARE PROVIDED BEFORE EACH ATTACHMENT'S OPERATING INSTRUCTION.

## **SAVE THESE INSTRUCTIONS**

---

# TABLE OF CONTENTS

<b>IMPORTANT SAFEGUARDS</b> .....	<b>3</b>
<b>TABLE OF CONTENTS</b> .....	<b>5</b>
<b>ABOUT YOUR KITCHEN MACHINE</b> .....	<b>6</b>
Bosch Universal Kitchen Machine .....	6
Unpacking .....	6
Electrical Specifications .....	6
Before Using for the First Time .....	7
<b>GETTING TO KNOW YOUR KITCHEN MACHINE</b> .....	<b>8</b>
Special Accessories .....	8
Power Unit Features .....	9
<b>GETTING STARTED</b> .....	<b>10</b>
<b>STANDARD ATTACHMENTS</b> .....	<b>12</b>
<b>MIXING BOWL WITH TWIN BEATING WHISKS AND DOUGH HOOK</b> ....	<b>12</b>
How to Use Dough Hook .....	13
How to Use Twin Beating Whisks .....	14
Dough hook and whisk assembly .....	16
Mixing bowl tips .....	17
Removing Contents .....	17
Care and Cleaning of Bowl and Its Accessories .....	18
<b>BLENDER WITH PLASTIC JAR</b> .....	<b>19</b>
How to Use Blender .....	20
Placing Blender into Operation .....	21
Removing Contents .....	21
Care and Cleaning of Blender .....	22
Example of Use of Blender .....	22
Tips .....	22
<b>SERVICE AND REPAIR</b> .....	<b>23</b>
<b>TROUBLESHOOTING</b> .....	<b>24</b>
<b>SAMPLES RECIPES</b> .....	<b>25</b>
Salsa .....	25
Pesto .....	25
Fruit Smoothies .....	25
French Bread .....	25
Oatmeal Chocolate Chip Cookies .....	26
Yeast Dough .....	26
Basic cake batter .....	26
Cookie dough .....	26
Pancakes .....	27
Whole wheat bread .....	27
<b>BOSCH SMALL APPLIANCE WARRANTY</b> .....	<b>28</b>

---

# ABOUT YOUR KITCHEN MACHINE

Congratulations on having selected one of the best kitchen machines in the world.

As you read through these instructions, please pay particular attention to the **IMPORTANT SAFEGUARDS**. Specific safeguards for the attachments, as well as warnings and cautions, are provided in each section describing the operation of that particular attachment.

## Bosch Universal Kitchen Machine

The Bosch Universal Kitchen Machine is available in 2 models:

### The MUM6N10UC

- comprised of the electronic power unit with six-quart capacity mixing bowl, splash ring and cover, twin beating whisks, dough hook and motor drive cover.

### The MUM6N11UC

- comprised of the electronic power unit with six-quart capacity mixing bowl, splash ring and cover, twin beating whisks, dough hook, six-cup capacity blender and motor drive cover.

## Unpacking

Carefully remove the power unit from its packaging and place it on the counter so it is ready to use. As you remove the accessories from the carton, check them against figure 1 to assure that all the standard parts are present.

## Electrical Specifications

Check to make sure that the voltage on which your kitchen machine is to operate is the same as specified on the rating plate. Standard North American models have an electrical power rating of 800-watt maximum power rating with the attachment that draws the most power (some attachments may draw less power).

## Before Using for the First Time

Before using any of the attachments for the first time it is recommended they be washed, rinsed well and dried.

Of the attachments supplied with the systems in this manual, all parts, except the dough hook, the motor drive cover and the blender's blade/base assembly, are dishwasher safe.

- ❑ The dough hook should be hand washed in warm soapy water, rinsed and dried.
- ❑ The motor drive cover should be only wipe up with a patch.
- ❑ The blender's blade/base assembly should be washed under running water and dried.
- ❑ **i** It is recommended that the blender's blade/base assembly never be left to stand in water or soap solution, to prevent the bearing lubricant from being washed out.

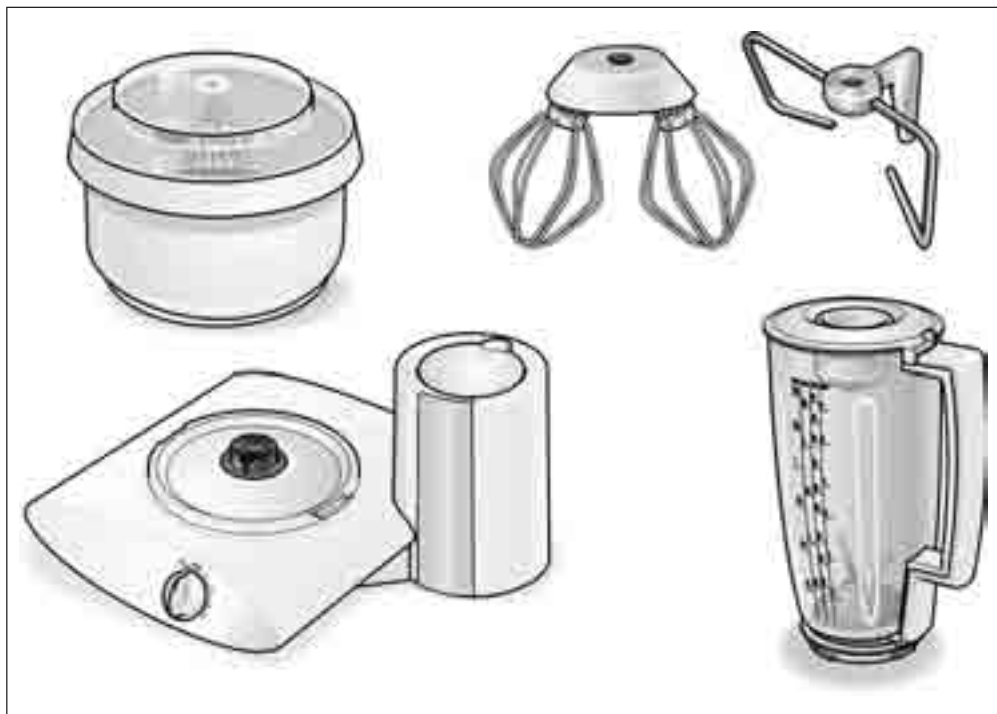

Figure 1

---

# GETTING TO KNOW YOUR KITCHEN MACHINE

## Special Accessories

To allow you to get the most service from your Bosch Universal Kitchen Machine, Bosch engineers have designed a line of special accessories to expand the usefulness of your machine.

In addition to standard accessories that come with your machine, Bosch offers many optional accessories.

These optional accessories can be ordered separately.

To view all currently available accessories, visit our Web site at [www.boschappliances.com](http://www.boschappliances.com).

Our work on expanding the usefulness of the Bosch Kitchen Machine is a continuing process.

If there is some type of accessory in which you are interested in, please either write us at:

### **Bosch Small Appliances**

Customer Support  
BSH Home Appliances  
5551 McFadden Avenue  
Huntington Beach, CA 92649  
or call us at:  
1-800-944-2904



## Power Unit Features

All MUM 6Nxx power units have the following features, refer to figure 2:

### 800-watt motor

Handles up to 12–14 lbs of dough.  
Heavy duty construction to give unsurpassed durability.

### Electronic speed control

Six-position rotary switch (figure 2a) is located at the front of the power unit: 4 speeds plus a momentary “pulse” function and a stop position “O/Off,” see figure 2a.

### Convenient cord storage

Convenient cord storage is located on the back of the power unit, see 2b.

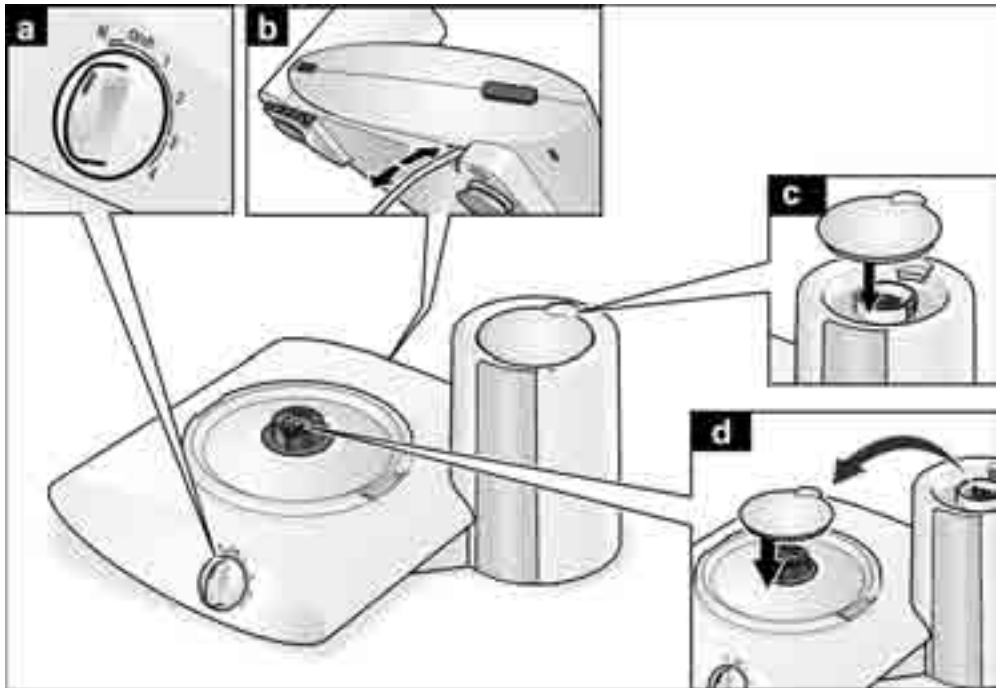

Figure 2

### Dual drives

The Universal Kitchen Machines come with two drives:

1. A high-speed drive directly coupled to the motor, used to drive the blender. See figure 2c.
2. A high-torque drive used to drive the stirring/beating whisks and the dough hook. See figure 2d.

### Motor drive cover

Used to cover drive that is not in use, see figure 2c/d.

### Attention:

**It is imperative to cover the high-speed drive if you do not use the blender. If the cover is not in place, the motor will not start!**

# GETTING STARTED

The operation of your Bosch Universal Kitchen Machine is summarized below.

Specific instructions for each of the attachments included with your machine are listed separately. Please read the specific instructions thoroughly before using that attachment, paying particular attention to the IMPORTANT SAFEGUARDS and WARNINGS provided.

## 1. Place power unit on suitable work surface.

Before using the machine with any of the attachments, the power unit should be placed on a suitable work surface. The surface should be sturdy, smooth and clean; make sure that there is no flour or oil on the surface. A clean, smooth surface will provide the best footing for the suction cup feet on the power unit and will limit slipping and/or “walking”.

## 2. Plug power unit into power supply.

Unwind the power unit’s cord to appropriate length and plug it into a convenient nearby receptacle.

## 3. Remove motor drive cover.

If necessary, remove motor drive cover from drive that will be used and place it on drive that will not be used. The cover, when placed on the high-speed drive, can be locked in position by pressing down, see figure 2c.

## 4. Select attachment to be used.

Select the attachment you wish to use and place on power unit. See specific instructions for attachment selected on pages listed below:

Attachment	Pages
Mixing bowl w/dough hook	13
Mixing bowl w/twin whisks	14
Blender	19

## 5. Operate unit with rotary switch.

Once the attachment is in place, the speed of its moving components can be controlled through the use of the rotary switch at the front of the power unit. See figure 2a. The rotary switch has five positions:

- “M,” a momentary “pulse” position that provides full speed and power for the time it is held in position.
- “O/Off,” the off position.
- Four speeds labeled 1, 2, 3 and 4. Speed 1 is the lowest speed. The speed increases with each succeeding step up to the highest speed, speed 4.

All models of the Bosch Universal Kitchen Machines incorporate a built-in safety cutout switch to protect the motor against overheating. If the safety becomes activated, the power unit will stop. If the power unit should stop even though there is power to the unit see TROUBLE-SHOOTING at the back of this manual.

#### **6. Turn power unit off.**

When your work with the attachment is completed, turn the power unit to the Off position, "O/Off," and unplug.

#### **7. Remove the attachment.**

Remove the attachment from the power unit. See instructions for the specific attachment being used.

#### **8. Continue use.**

On certain attachments, the container will need to be periodically emptied when working with large quantities.

#### **9. Place contents (batch-feed type).**

If the attachment is the batch feed type, disassemble per the specific attachment's instructions and place the contents in a suitable container.

#### **10. Care and Cleaning**

Once you have completed working with the Bosch Kitchen Machine, the next step is to disassemble and clean the attachments. Refer to care and cleaning section for specific instructions.

If you wish to use another attachment, please return to step 4, above.

#### **Power unit**

With the power unit turned Off and unplugged, it should be cleaned only with a clean, damp cloth. Then wipe off the motor drive cover and reinstall on the power unit. Never use coarse or caustic cleaning products to clean the power unit. Never immerse the power unit in water.

The power unit may be left on the counter or stored for future use. If the unit will be stored, lift the power unit and place in your chosen storage area.

#### **Attachments**

The attachment(s) that have been used should be disassembled and washed, per their specific instructions, dried and stored for future use.

# STANDARD ATTACHMENTS

Following are the specific instructions for the standard attachments provided with the Bosch Universal Kitchen Machines covered by this manual.

## MIXING BOWL WITH TWIN BEATING WHISKS AND DOUGH HOOK



### WARNING



1. There is a risk of injury from rotating tools when using the mixing bowl with the dough hook or the twin beating whisks.
2. Avoid contact with moving parts. Keep hands, hair and clothing, as well as spatulas, bowl scrapers and other utensils away from dough hook and whisks during operation to prevent injury and/or damage to the power unit or accessories.
3. Always work with the bowl lid and splash ring fitted in place.
4. Do not change tools until the power unit has come to a complete stop; when switched Off, the power unit will continue to turn for a brief period.

All models of the Bosch Universal Kitchen Machines are provided with a six-quart mixing bowl with twin beating whisks and dough hook.

If additional mixing bowls are desired, they are available as accessory items.

The mixing bowl with dough hook and twin beating whisks consists of the following components, see figure 3:

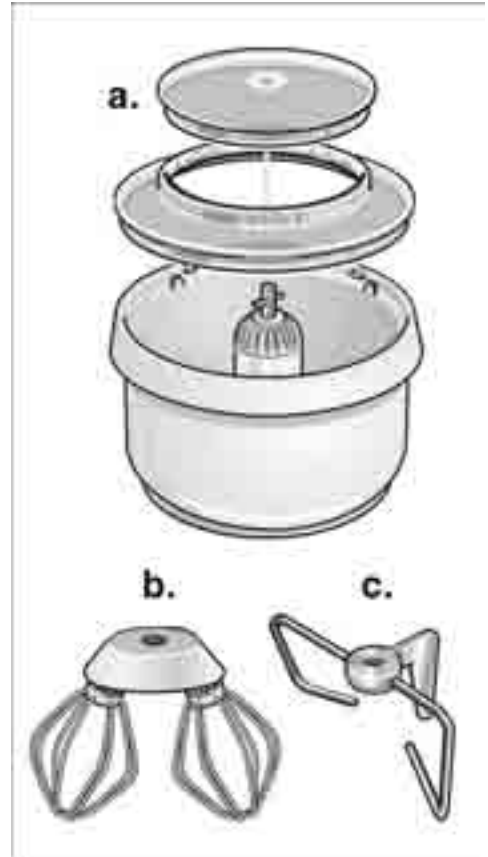

**Figure 3**

- 3a. Bowl with cover and splash ring
- 3b. Twin beating whisks
- 3c. Dough hook

## How to Use Dough Hook

The dough hook is intended to be used to knead yeast doughs and to mix cookie and pastry doughs. Also when adding nuts, chocolate chips, dried fruit, hard butter or shortening, hardened brown sugar, etc. to batters.

### Use of mixing bowl with dough hook

Before beginning to attach this or any other attachment, make sure that the power unit is on a smooth, clean, suitable work surface and switched to the Off position, "O/Off," and that you have, if necessary, moved the motor drive cover to the drive that will not be used.

1. Before using the mixing bowl and dough hook for the first time, it is recommended that the bowl, cover, splash ring and dough hook be washed. All components of the mixing bowl, except the dough hook, are dishwasher safe. The dough hook may be washed in warm soapy water. After washing, rinse well and dry before using.
2. If you have not already done so, move the motor drive cover to the high-speed drive.

**The power unit does not start if the motor drive cover is not in place.**

3. Place the mixing bowl on the high-torque drive of the power unit and turn the bowl counterclockwise with a slight downward pressure until bowl is firmly seated, see figure 4a.

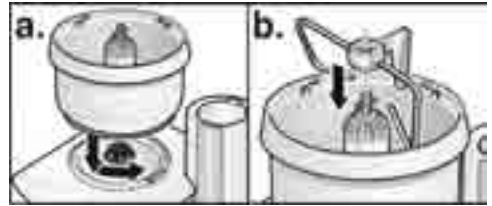

Figure 4

## ATTENTION

Failure to make sure that the bowl is properly seated on the drive coupling before the power unit is turned On can result in damage to the bowl and/or coupling.

4. Engage the dough hook on the driveshaft of the mixing bowl by placing it over the center column, as shown in figure 4b. Once in place, check to make sure dough hook has engaged the driveshaft by turning the dough hook clockwise while pushing down until it stops.
5. Place the splash ring on the bowl, making sure the tabs on the bowl fit into the recesses in the splash ring, and turn counterclockwise, see figure 5a. Then place the cover on the splash ring so that the tabs on the splash ring fit into the recesses in the bowl cover and turn the cover counterclockwise to fasten the bowl cover to the bowl. See figure 5b.

The splash ring and cover should be in place whenever the power unit is in operation. The splash ring and cover serve to prevent the escape of flour dust at the beginning of the stirring and kneading process, and also serves to prevent accidental contact with the moving dough hook.

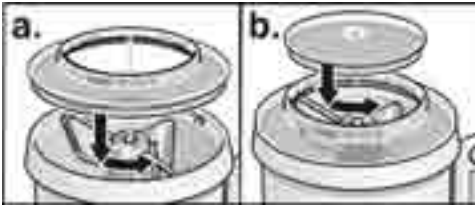

**Figure 5**

### Placing into Operation Dough Hook

Make sure that the power unit is on a smooth, clean, suitable work surface and switched to the Off position, “O/Off”. Unwind the electrical cord to the necessary length and plug into a convenient outlet. The mixing bowl with dough hook is now ready for operation. See table 1 for examples demonstrating the use of the dough hook attachment. Sample recipes may also be found in the recipe section, at the back of this manual.

## How to Use Twin Beating Whisks

All Bosch Universal Kitchen Machines come with a twin beating whisk assembly, see figure 4c.

The twin beating whisks is intended to be used for very light substances, such as cream, egg whites, sauces, batters and light pastry doughs that are thin enough to pour.

The dough hook should be used for all heavier substances such as cookie doughs, yeast doughs, pastry doughs and other heavy doughs. The dough hook should always be used when adding nuts, chocolate chips, dried fruits, hard butter or other fats, hardened brown sugar, etc. to a mixture.

### Use of mixing bowl with twin beating whisks

Before beginning to attach this or any other attachment, make sure that the power unit is on a smooth, clean, suitable surface and switched to off position, “O/Off,” and that you have moved the motor drive cover.

1. Before using the mixing bowl and twin beating whisk assembly for the first time, it is recommended that the bowl, splash ring, cover and twin beating whisk assembly be washed. All components of the mixing bowl and the twin beating whisk assembly are dishwasher safe.
2. If you have not already done so, move the motor drive cover to the high-speed drive.

**The power unit does not start if the motor drive cover is not on its place.**

3. Place the mixing bowl on the high-torque drive of the power unit and turn the bowl counterclockwise with a slight downward pressure until bowl is firmly seated, see figure 4a.

## ATTENTION

Failure to make sure that the bowl is properly seated on the drive coupling before the power unit is turned On can result in damage to the bowl and/or coupling.

4. Place and engage the twin beating whisk assembly on the driveshaft of the mixing bowl as shown in figure 6. Make sure that the toothed wheel interlocks with the drive shaft.

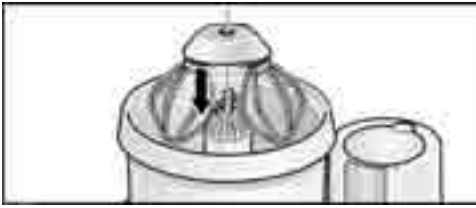

**Figure 6**

5. Place the splash ring on the bowl, making sure the tabs on the bowl fit into the recesses in the splash ring, and turn counterclockwise, see figure 5a. Then place the cover on the splash ring so that the tabs on the splash ring fit into the recesses in the bowl cover and turn the cover counterclockwise to fasten the bowl cover to the bowl. See figure 5b.

The splash ring and cover should be in place whenever the power unit is in operation. The splash ring and cover serve to prevent the escape of flour dust at the beginning of the stirring and kneading process, and also serves to prevent accidental contact with the moving whisks.

### **Placing into Operation Twin Beating Whisks**

Make sure that the switch is in the off position, "O/Off". Unwind the electrical cord to the necessary length and plug into the wall outlet. The bowl with whisk assembly is now ready for operation. See table 1 for examples demonstrating the use of the twin beating whisks.

## Dough hook and whisk assembly

Below you will find a table listing examples of how the dough hook and the whisk assembly are to be used for various typical applications.

Attachment	Ingredients	Speed	Time	Max. Amount
Twin beating whisks	Egg whites (2)	4	2 min. (approx.)	20 eggs (approx.)
	Whipping cream (1 cup)	3–4	2 min.	6 cups (approx.)
	Sponge cake (any recipe) 3 eggs			
	Combine all ingredients	1	½ min.	9 eggs
	Whip	4	4–6 min.	(6 layers)
	Fold in flour mixture	1	1 min.	
	Basic cake batter			
	Combine all ingredients	1	½ min.	3x basic recipe
	Mix	4	3–6 min.	(6 layers)
Twin beating whisks/dough hook	Cookie dough			
	Cream soft butter or shortening and sugar using twin beating whisks	3	2 min.	3x basic recipe
	Combine flour alternately with liquid using dough hook	2 or 3	3 min.	(9 dozen cookies)
	Stir in nuts, chocolate chips, etc. using dough hook			
Dough hook	Yeast Dough			
	Combine all wet ingredients	1	½ min.	3x basic recipe
	Add flour in portions	2 or 3	5 min. (approx.)	(10, 1 lb. loaves)

**Examples** of operation using whisk assembly and dough hook. Speed 1 should be used for initial stirring and combining. Place all ingredients into the mixing bowl, liquids first. Shortening must be soft (room temperature).



## Mixing bowl tips

1. When using the mixing bowl to knead or mix a recipe designed to be prepared by hand, you will find that with the Bosch Kitchen Machine you can usually place all the ingredients in the mixing bowl at once. When doing this, always place the liquids in first. This will assure more thorough mixing.
2. When adding ingredients to a mixture:
  - a. Turn the rotary switch to a lower speed;
  - b. Remove the cover from the splash ring;
  - c. Add the ingredients through the cover opening and replace the cover.
3. If a large batch of dough is to be left in the mixing bowl and allowed to rise, the cover and splash ring should be removed and placed loosely on the bowl so that it is free to move if the dough should begin to press on it.

## Removing Contents

Before beginning to remove the contents from the mixing bowl, make sure that the power unit has been turned to the Off position, "O/Off". Remove the cover and splash ring by turning clockwise and lifting off. Once the cover and splash ring have been removed, the dough hook or the twin beating whisks may be removed by turning the hook or whisk assembly clockwise while lifting.

The mixing bowl can be removed from the power unit by turning the bowl clockwise while lifting.

The contents may now be used as desired.

## Care and Cleaning of Bowl and Its Accessories

Except for the dough hook, the mixing bowl and its accessories are dishwasher safe.

To dry the inner part of bowl after washing, remove it.

The axle/center column can be easily removed by inverting the bowl and turning the axle/center column. Turn it counterclockwise, see figure 7a.

Invert the bowl and remove the axle/center column by turning slightly while pulling, see figure 7b.

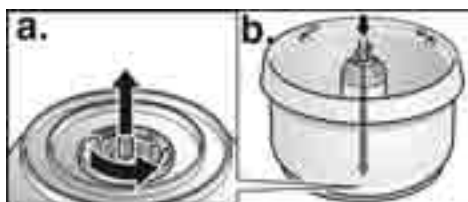

**Figure 7**

After drying the axle/center column may be placed back by reversing the action.

It is recommended that the dough hook be washed by hand in warm soapy water, rinsed well and dried after each use. The whisks can be removed from the whisk holder by simply pulling them off, see figure 8a.

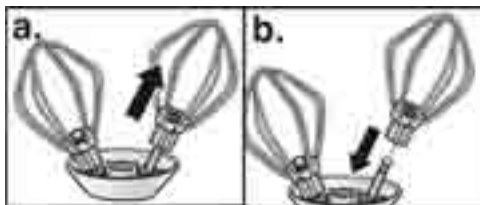

**Figure 8**

After washing, rinsing and drying, the whisks may be placed back on the whisk holder by reversing the action to remove them, see figure 8b. Press them on until they snap into place.

The power unit of the kitchen machine should be cleaned using a clean, damp cloth only. Never use coarse or caustic cleaning products to clean this appliance. Never immerse the power unit in water.

## BLENDER WITH PLASTIC JAR



### CAUTION



1. There is a risk of injury from sharp blades when using the blender attachment. Handle carefully.
2. Keep hands and utensils out of the blender jar while it is attached to the power unit.
3. To avoid injury, never place blade assembly on power unit without blender jar properly attached.
4. Always operate the blender with the cover in place. Always hold cover in place while operating the blender to prevent cover from coming loose.
5. The use of attachments, including blender jars, not recommended by the manufacturer, may cause risk of personal injury.
6. When blending hot and/or frothing liquids, process a maximum of 18 fluid ounces (0.5 litres) at a time.



**Figure 9**

- 9a. Cover closure/funnel
- 9b. Cover
- 9c. Blender jar
- 9d. Sealing ring
- 9e. Blade/base assembly

The MUM 6N11 UC Bosch Universal Kitchen Machine includes the blender accessory. The blender accessory consists of, figure 9.

## How to Use Blender

The blender has been designed for crushing ice; mixing liquids; pureeing vegetables; preparing special diet and infant foods; pulverizing fruit, vegetables, nuts and dried bread (for bread crumbs); and preparing mayonnaise and sauces.

Before beginning to use this or any other attachment, make sure that the power unit is on a clean, smooth, suitable work surface and switched to off position, “O/Off,” and that you have removed the motor drive cover.

1. Before using the blender for the first time, it is recommended that the blender jar cover, closure/funnel and blade/base assembly be washed. All components, except the blade/base assembly, are dishwasher safe. Remove the blade/base assembly from the blender, see figure 9.



### CAUTION



Blade/base assembly is very sharp.  
Handle with care.

The blade/base assembly may be easily removed by inverting the blender and using the blender cover to fit over the tabs on the blade/base assembly. Turn it counterclockwise until it stops, see figure 10a, and then lift up, figure 10b.

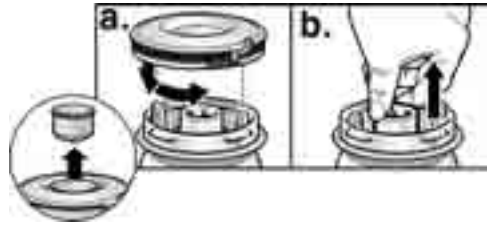

Figure 10

2. To assemble or reassemble blade/base assembly into the blender, insert the blade/base assembly into the blender jar and press down on the blade/base assembly. Turn clockwise to the stop, see figure 11. The blade/base assembly is then back in place.

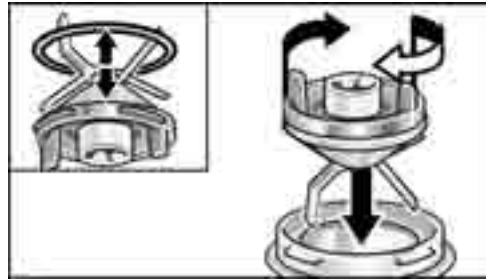

Figure 11

3. If you have not already done so, move the motor drive cover to the high-torque drive, see figure 12.

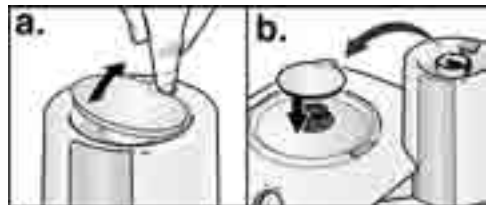

Figure 12

4. Place the blender with cover on the high-speed drive of the power unit. Note the mark on the appliance and on the blender. Turn the blender counterclockwise with a slight downward pressure until the jar is firmly seated, see figure 13.

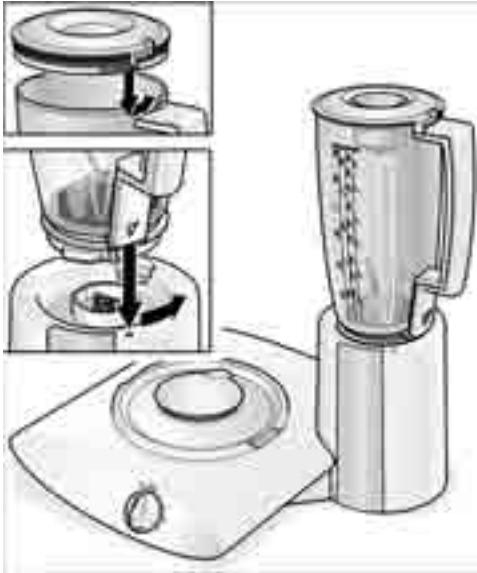

Figure 13

## Placing Blender into Operation

Normally when blending, the blender jar should be filled with the entire amount of material to be blended, if possible, before switching the appliance on. The cover and cover closure should always be in place after filling the blender jar and before switching the power unit to On.

Any subsequent additions to the blended material should be made through the cover opening, see figure 14.

For solids and/or granular material, remove the cover closure/funnel to add the material, as shown in figure 14a. For liquids, the closure/funnel may be left in place and the liquids added by pouring it into the closure/funnel, see figure 14b.

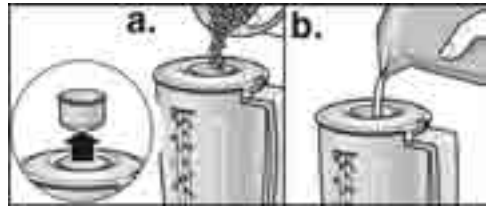

Figure 14

## Removing Contents

Before beginning to remove the contents from the blender, make sure that the power unit has been turned to the Off position, “O/Off”. Remove the blender from the power unit by turning the blender clockwise while lifting. With the blender removed from the power unit, the contents of the blender may now be poured into a suitable container or bowl, as desired.

## Care and Cleaning of Blender

All components of the blender, except the blade/base assembly, are dishwasher safe. It is recommended that the blade/base assembly be cleaned only under flowing water rather than in the dishwasher. Soap and detergent will tend to wash out the bearing lubricant of the blade/base assembly. Do not use scouring cleaners on any of the blender parts.

Wash the blade/base assembly under running water. Do not place the blade/base assembly in the dishwasher or allow it to stand in water. This will tend to wash out the lubricant. After cleaning, rinse thoroughly and dry before using.

The power unit of the kitchen machine should be cleaned with a clean, damp cloth only. Never use coarse or caustic cleaning products to clean this appliance. Never immerse the power unit in water.

## Example of Use of Blender

To familiarize you with the operation of the blender, a sample recipe for mayonnaise is provided below:

### Mayonnaise Recipe

- 1 whole egg
- 1/3 cup of vegetable oil
- 2 tablespoons lemon juice or light vinegar
- 1 teaspoon sugar
- 1/2 teaspoon dry mustard
- 1/2 teaspoon of salt
- 2/3 cup of vegetable oil

Mix all ingredients, except final 2/3 cup of oil, for a few seconds at speed 1, then quickly pour the oil in through the opening in the cover in a uniformly thick stream, as shown in figure 14b. Operate the blender at speeds 1 or 4 until mixture is thick and smooth (approximately 10–20 seconds). Makes 1 1/4 cups.

## Tips

The blender should be operated with careful consideration as to what is required and/or desired. The speed at which the blender is operated and the length of operation for a given job will depend upon the degree of fineness desired or the amount being blended.

When the blender is being used on dry materials, such as nuts or dry bread, the best results will be obtained when the blender jar is filled with approximately 1/2 cup of material to be blended.

If the blender does not start (even after trying the highest speed) and it is humming or not functioning at all, the blade has become blocked by the contents. Try to switch to the “M” position to unlock the blades. If this does not unlock the blades refer to troubleshooting section.

---

## SERVICE AND REPAIR

The Bosch Universal Kitchen Machines require no special care other than the care and cleaning noted in this manual. If you are having a problem with your machine, before calling our Customer Support group, please refer to the TROUBLESHOOTING section below.

If, after reviewing the troubleshooting section and trying its remedies, you are still having a problem, please do contact us by either writing to us at:

### **Bosch Small Appliances Customer Support**

BSH Home Appliances  
5551 McFadden Avenue  
Huntington Beach, CA 92649

or e-mailing us at:

**[boschappliances@bshg.com](mailto:boschappliances@bshg.com)**

or calling us at:

1-800-944-2904

If you do write to us, please include your e-mail address or a daytime telephone number where you may be reached.

Also, to view our full product line, please visit our Web site:

**[www.boschappliances.com](http://www.boschappliances.com)**

---

# TROUBLESHOOTING

<b>Problem</b>	<b>Possible Cause and Remedy</b>
The power unit does not start if you use the bowl and attachments.	The motor drive cover is not on the high-speed drive. <ul style="list-style-type: none"><li>• Put the cover on its place.</li></ul>
The power unit stops while working.	The safety coutout to protect the motor against overheating has switched off the power unit. <ul style="list-style-type: none"><li>• Turn the power unit to the “Off” position “0/Off” and unplug.</li><li>• Allow it to cool down for 15 minutes.</li></ul>
The blender does not work.	The blender cover is not closed completely. <ul style="list-style-type: none"><li>• Close the cover completely.</li></ul> The blade has become blocked by the contents. <ul style="list-style-type: none"><li>• Turn the power unit to the “Off” position “0/Off” and unplug. Remove the blender and pour the content into a suitable container.</li></ul>
The blender stops while working.	The blender jar or the blender cover is not attached completely. <ul style="list-style-type: none"><li>• Turn the blender jar /blender cover counterclockwise until it is firmly seated.</li></ul>



---

## SAMPLE RECIPES

### Salsa

Chop the following ingredients in Bosch blender or food processor, on speed 3:

- 1–4 Dried Arabol Chillies (start with one, add more for increased spiciness)
- 1 clove garlic
- 1/8 cup water
- 8 ounces tomato sauce (add half)

#### Next add:

- 1 1/2 teaspoons oregano
- 3/4 teaspoons cumin
- 1 bunch of fresh cilantro
- 1 pinch of salt
- second half of tomato sauce

- Blend** all ingredients, on speed 2 or 3, until smooth.

### Pesto

- 1 cup loosely packed basil leaves
- 1/2 cup grated parmesan
- 1/3–1/2 cup olive oil (enough for desired consistency)
- 1 – 2 cloves garlic
- 1/4 cup shelled pinenuts

- Lightly toast** pinenuts. Let cool. Place olive oil in Bosch blender or food processor. Turn on power and gradually add parmesan cheese, garlic and basil leaves. Process, on speed 2 or 3, until smooth. Add pinenuts and blend thoroughly.

- Toss** with cooked pasta or spread on bread or crackers.

### Fruit Smoothies

- 2 cups fruit juice
- 2 cups frozen fruit
- 1/2 can frozen juice concentrate
- 1 cup fruit flavored yogurt
- 1–2 cups of ice
- 1 fresh banana

- Place** all ingredients in Bosch blender. Turn momentary “M” switch to unlock blades. Then mix until smooth, on speed 3 or 4. Experiment with different flavor combinations such as tropical, berry or melon.

### French Bread

- 4 tablespoons active dry yeast
- 4 cups hot water
- 6 tablespoons sugar
- 2 tablespoons salt
- 1 cup vegetable oil
- 10–12 cups of flour (white or wheat)
- 4 tablespoons gluten

- Place** all ingredients in Bosch mixing bowl.

- Thoroughly knead** on speed 3 (4–6 minutes). Let rise in the bowl 10 minutes, then punch down. Punch down 4 or 5 times. Divide into 3–4 regular loaf pans or shape into rounds. Slash tops with sharp knife and brush with egg wash. Let rise until doubled in size. Bake 30 minutes at 400 °F.

## Oatmeal Chocolate Chip Cookies

2 cups packed brown sugar  
1 cup shortening  
2 eggs  
1 teaspoon vanilla  
1¾ cups flour  
1 teaspoon baking soda  
½ teaspoon salt  
3 cups quick-cooking rolled oats  
1 cup chocolate chips

- ❑ **Cream** the brown sugar, shortening, eggs and vanilla in the mixing bowl, on speed 2 or 3. Add flour, baking soda and salt. Blend well, add in rolled oats and chocolate chips on speed 1. Drop by spoonfuls onto greased baking sheets. Bake in 350 °F oven for 8–10 minutes. Cool before removing from pan. Makes 5 dozen.

## Yeast Dough

Basic recipe

3 ½ cups plain flour  
1 tablespoon Instant Yeast  
1 cup – 1 ⅛ cup warm milk  
⅓ cup sugar  
⅓ cup butter or margarine  
Peel of ½ lemon  
Pinch of salt

- ❑ Start by mixing all ingredients together on speed 1 for ½ min, continue on speed setting 3 for 4 – 6 min.

## Basic cake batter

Basic recipe

4 eggs  
1 ¼ cup sugar  
1 tablespoon vanilla sugar  
1 ½ cup butter or margarine  
3 ½ cups flour  
1 teaspoon baking powder  
⅔ cup milk

- ❑ Start by mixing all ingredients together with beating whisks on speed 1 for ½ minutes; continue on speed setting 3 or 4 for 4 – 6 min.

## Cookie dough

Basic recipe

⅔ cup butter  
⅔ cup sugar  
1 egg  
Pinch of salt  
1 teaspoon vanilla essence  
2 cups flour  
½ teaspoon baking powder

- ❑ Cream soft butter and sugar with beating whisks, then flour, egg, salt and baking powder with dough hook kneading.

## Pancakes

2 cups flour  
2 tablespoons baking soda  
2 teaspoons sugar  
¼ teaspoon salt  
1½ cup milk  
2 tablespoons oil

- ❑ Start by mixing all ingredients together with beating whisks on speed 1 for ½ minutes; continue on speed setting 3 or 4 for 2 – 4 min.

## Whole wheat bread

6 cups warm water  
⅔ cup oil  
⅔ cup honey  
2 tablespoons Kitchen Specialties Dough Enhancer  
2 tablespoons salt  
2 tablespoons Kitchen Specialties Vital Wheat Gluten  
2 tablespoons Instant Yeast  
10 – 15 cups freshly milled whole wheat flour

- ❑ Water, oil, honey and salt, Kitchen Specialties Dough Enhancer, Vital Wheat Gluten, yeast and 6 cups flour in mixing bowl. Turn the machine to speed 1, then on speed 2 and continue to add flour until the dough begins to pull away from the sides of the bowl (6 – 8 minutes).
- ❑ Put the dough into well greased pans immediately. Let the loaves rise until they are double in size.
- ❑ Bake in preheated oven at 350 °F for 40 – 45 minutes until golden brown.

## Honey spread

⅓ cup butter (from the refrigerator)  
1⅓ cup honey (from the refrigerator)

- ❑ Cut butter into small pieces and put into the blender.
- ❑ Add honey and blend for 15 seconds on speed 4.

---

# BOSCH SMALL APPLIANCE WARRANTY

BSH Home Appliances (“BOSCH”) warrants all new small appliances to be free from original defects in design, materials and workmanship for one (1) year after the sale to the original owner.

Within the stated warranty period, BOSCH will repair or replace, at its sole option, any small appliance or parts thereof which prove defective under the conditions of normal use and service at no charge to you. It is the owner’s responsibility to return the appliance for repair. Repaired and replacement small appliances and parts shall be the same or as close in appearance as possible to the original for the purposes of this warranty.

Should you require service of your BOSCH small appliance, please contact customer service at 1-800-944-2904. Repair of BOSCH appliances should only be performed by qualified technicians. This warranty is limited to the original consumer purchase and is not transferable. Specifically excluded from this warranty are failures caused by accident, misuse, neglect, abuse, including tampering, use of frequency or voltage other than marked on the product, and use for commercial purposes.

To the extent allowed by law, this warranty sets out your exclusive remedies, whether for negligence or otherwise. BOSCH will not be liable for any consequential or incidental damages, losses or expenses. THIS WARRANTY IS IN LIEU OF ALL OTHER EXPRESSED WARRANTIES. ANY WARRANTY IMPLIED BY LAW, WHETHER FOR MERCHANTABILITY OR FITNESS FOR A PARTICULAR PURPOSE OR OTHERWISE, SHALL BE EFFECTIVE ONLY FOR THE PERIOD THAT THIS EXPRESSED WARRANTY IS EFFECTIVE. BOSCH DOES NOT ASSUME ANY RESPONSIBILITY FOR INCIDENTAL OR CONSEQUENTIAL DAMAGES.

No attempt to alter, modify or amend this warranty shall be effective unless authorized in writing by an officer of BOSCH. Some states do not allow limitations on how long implied warranties last or the exclusion or limitation of incidental or consequential damages, so the foregoing limitations and exclusions may not apply to you. This warranty gives you specific legal rights and you may also have other rights which vary from state to state.

Looking for more information about BOSCH products?

Visit our Web site: [www.boschappliances.com](http://www.boschappliances.com)

BSH Home Appliances Corporation  
5551 McFadden Avenue  
Huntington Beach, CA 92649  
USA

Web site: [www.boschappliances.com](http://www.boschappliances.com)

Customer Service (toll free): 1-866-44BOSCH (1-800-944-2904)

Appelez le service-client (gratuit): 1-866-44BOSCH (1-800-944-2904)

Servicio al cliente (libre de cargo): 1-866-44BOSCH (1-800-944-2904)