









HOOKER[®]

— FURNITURE —

ASSEMBLY INSTRUCTION

Item#: 5805-85003-96 Narrow Console

**** Please make sure you have all parts indicated below prior to assembly.
This table is heavy and can best be assembled with the help of two persons**

NO	HARDWARE LIST	Q'TY
A	 5/16" x 55MM ALLEN BOLT	8
B	 LOCK WASHER	16
C	 FLAT WASHER	16
D	 SMALL ALLEN WRENCH	1
E	 5/16" x 45MM ALLEN BOLT	8
F	 LARGE ALLEN WRENCH	1
G	 ADJUSTMENT LEVELER	8
H	 118MM BOLT	8

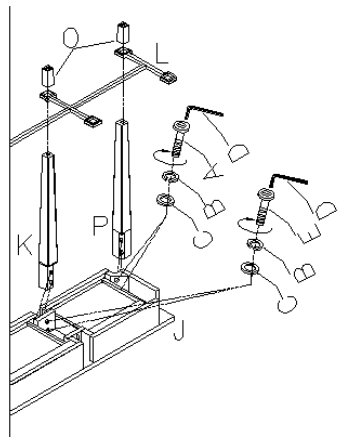
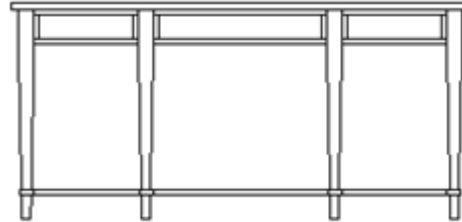

Diagram 1

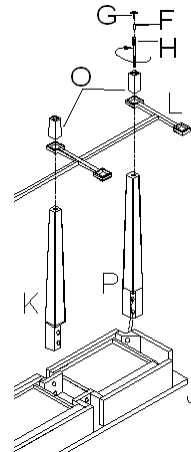

Diagram 2

Assembly Steps:

1. Put console top (J) upside down on a soft surface to prevent it from being scratched.
2. Attach side posts (P) to console top by using bolts (A), lock washers (B), flat washers (C), and tighten all with allen wrench (D) at corners. Then attach center posts (K) to console top by using bolts (E), lock washers (B), flat washers (C) and secured by using allen wrench (D) at center locations (See diagram 1).
3. Well place bottom metal stretcher (L) onto posts (K&P). Then place small foot (O) into metal stretcher (L) to make sure all pre-drilled holes are in alignment, insert bolts (H), tighten them with large allen wrench (F) in clockwise direction (See diagram 2).
4. Then tighten adjustment levelers (G) into bolts (H) (See diagram 2).

Cleaning Instruction: Clean finished parts with a damp cloth using a mild dishwashing liquid and water solution. Polish the finish with soft cloth and an industry recognized furniture polish.