

PowerLite® EB-L520W

Quick Reference

This *Quick Reference* card gives brief instructions on connecting your projector and using common features. For details, see the online *User's Guide*.

IMPORTANT: Before using this product, make sure you read these instructions and the safety instructions in the online *User's Guide*.

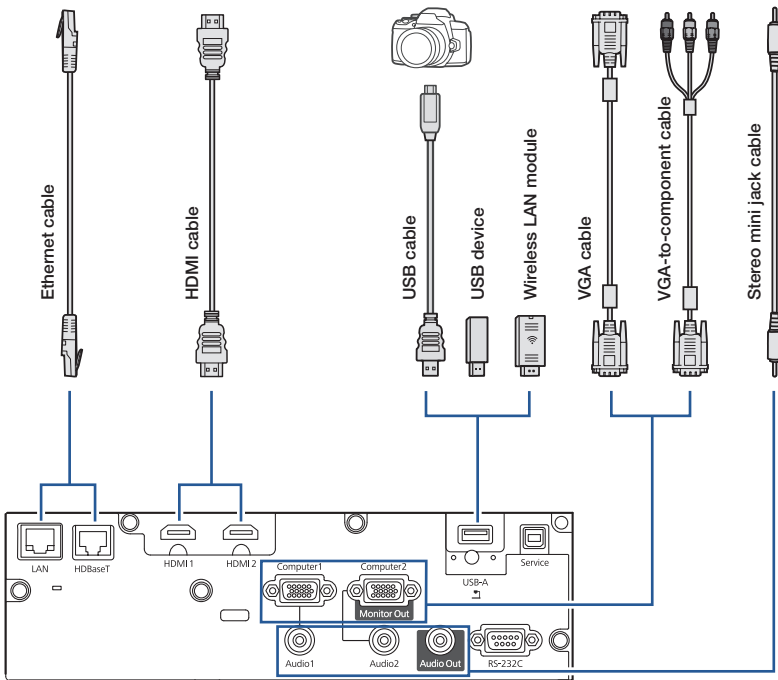

Turning the Projector On

1. Turn on your computer or image source.
2. Press the  power button on the projector or remote control. After the status light stays blue, the projector is ready.

Note: If the Direct Power On function is enabled, you can turn the projector on without pressing the  power button; just plug it in or flip the switch controlling the outlet to which the projector is connected. To turn on this feature, see the online *User's Guide*.

3. If your image does not appear, see “Switching Between Image Sources” or “Troubleshooting.”

Changing the Language of the Projector Menus

The default language of the projector's menu system is English, but you can change it as necessary.

1. Press the **Menu** button to access the projector's menu system.
2. Select **Extended > Language**.
3. Select your language.
4. When you're done, press the **Menu** button to exit.

Switching Between Image Sources

Press the **Source Search** button or one of the source buttons on the remote control.

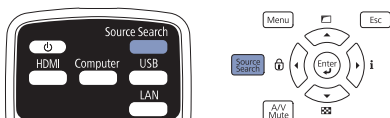

Displaying a Test Pattern

Note: See the online *User's Guide* for instructions on displaying a test pattern from the remote control using the Settings menu.

1. Press the down arrow/ button on the projector.

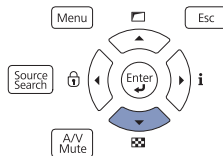

2. Press the **Enter** button to change the test pattern.
3. When you're done, press the **Esc** button to clear the test pattern.

Changing Screen Type

Set the Screen Type setting to the screen's aspect ratio.

1. Press the **Menu** button.
2. Select **Extended > Display > Screen > Screen Type**.
3. Select the screen's aspect ratio.

Note: The displayed image should match the screen's size and shape.

4. When you're done, press the **Menu** button to exit.

Note: After changing the screen type, you may need to change the aspect ratio of the projected image depending on the input signal. Press the **Aspect** button on the remote control to change the aspect ratio, if necessary.

Adjusting Image Position Using Screen Position

1. Press the **Menu** button.
2. Select **Extended > Display > Screen > Screen Position**.
3. Use the arrow buttons on the projector or remote control to adjust the position of the image.

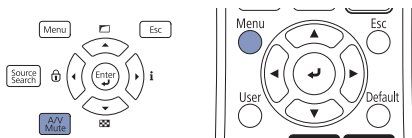

Focusing and Zooming

Turn the focus ring to sharpen the image.

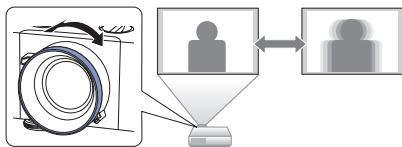

Turn the zoom ring to reduce/enlarge the image.

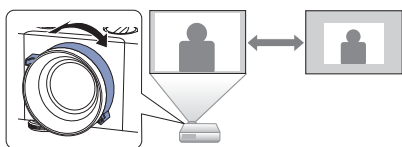

Correcting Image Shape

If your image is uneven on the sides, you can use the projector's distortion correction features, such as H/V-Keystone, Quick Corner®, and Arc Correction, to adjust the shape. See the online *User's Guide*.

Making Other Image Adjustments

For help on using the projector's features to improve the image quality, see the online *User's Guide*.

Turning the Projector Off

Press the \odot power button on the projector or remote control. If you see a confirmation message, press the \odot power button again.

Note: If the Direct Power On function is enabled, you can flip the switch controlling the outlet to which the projector is connected instead. To turn on this feature, see the online *User's Guide*.

With Epson's Instant Off® technology, you don't have to wait for the projector to cool down; just turn it off or unplug it when you're done.

Troubleshooting

If you see a blank screen or the message **No signal**

- Make sure the status light on the projector is blue and not flashing.
- Make sure the cables are connected correctly. See the online *User's Guide*.
- You may need to change the image source. See "Switching Between Image Sources." Also make sure the source device is turned on.

If the projector and the notebook don't display the same image

Windows®

If you are using a Windows laptop, press the function key on your keyboard that lets you display on an external monitor. It may be labeled **CRT/LCD** or have an icon such as . You may have to hold down the **Fn** key while pressing it (such as **Fn + F7**). Wait a moment for the display to appear.

On Windows 7 or later, hold down the Windows key and press **P** at the same time, then click **Duplicate**.

Mac

Open **System Preferences** and select **Displays**. Click the **Arrangement** tab and select the **Mirror Displays** checkbox.

Where to Get Help

Manuals

For more information about using the projector, you can view or download the online manuals from the Epson website, as described below.

Internet support

Visit www.epson.com/support (U.S.) or www.epson.ca/support (Canada) and search for your product to download software and utilities, view manuals, get FAQs and troubleshooting advice, or contact Epson.

Speak to a support representative

To use the Epson® PrivateLine® Support service, call (800) 637-7661. This service is available for the duration of your warranty period. You may also speak with a projector support specialist by dialing (562) 276-4394 (U.S.) or (905) 709-3839 (Canada).

Support hours are 6 AM to 8 PM, Pacific Time, Monday through Friday, and 7 AM to 4 PM, Pacific Time, Saturday.

Days and hours of support are subject to change without notice. Toll or long distance charges may apply.

Purchase supplies and accessories

You can purchase an air filter (V13H134A56), screens, or other accessories from an Epson authorized reseller. To find the nearest reseller, call 800-GO-EPSON (800-463-7766). Or you can purchase online at www.epsonstore.com (U.S. sales) or www.epsonstore.ca (Canadian sales).

For a list of optional accessories, see the online *User's Guide*.

Remote Control Map

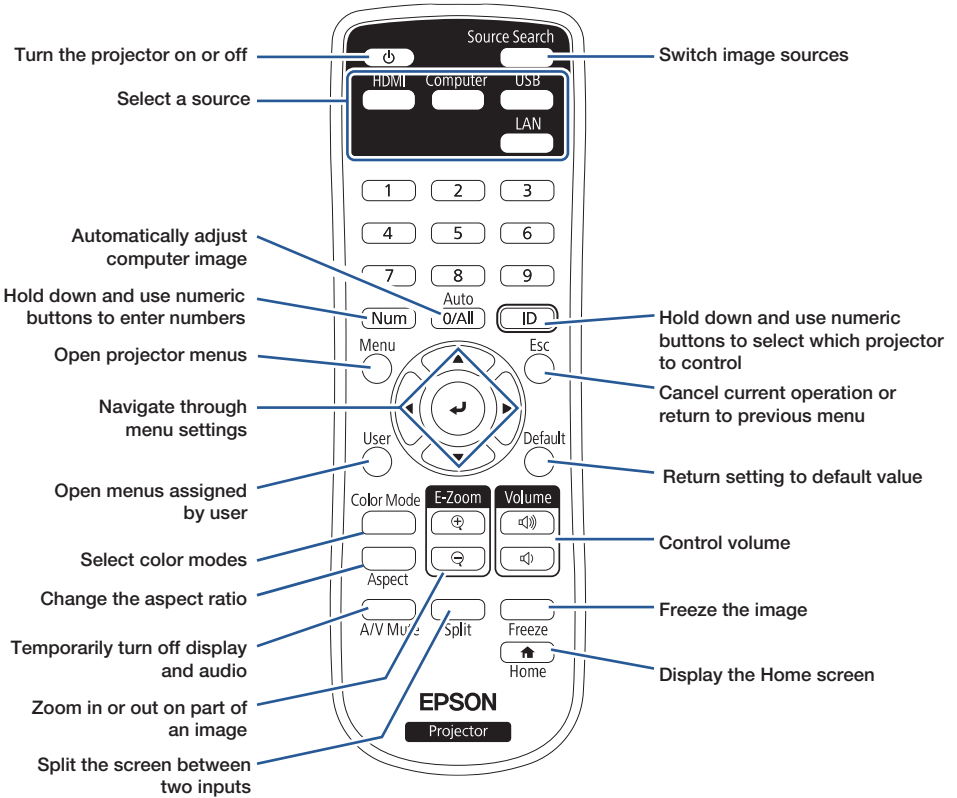

EPSON[®]
EXCEED YOUR VISION



EPSON, Instant Off, PowerLite, and Quick Corner are registered trademarks and EPSON Exceed Your Vision is a registered logomark of Seiko Epson Corporation.

PrivateLine is a registered trademark of Epson America, Inc.

Windows is a registered trademark of Microsoft Corporation in the United States and/or other countries.

Mac is a trademark of Apple Inc., registered in the U.S. and other countries.

HDBaseT is a trademark of the HDBaseT Alliance.

General Notice: Other product names used herein are for identification purposes only and may be trademarks of their respective owners. Epson disclaims any and all rights in those marks.

This information is subject to change without notice.

© 2021 Epson America, Inc., 2/21

CPD-60564



414130400