

User & Care Manual

Single Wall Oven

Microwave Combo



Electrolux.com/register

2

Welcome to Electrolux! Thank you for choosing our appliance.

For Customer Care support and webshop, or to download an extended version of this manual, visit: ElectroluxAppliances.com

Important Safety Instructions	3	Setting Microwave Controls	54
Cooking Recommendations	11	Care and Cleaning	60
Before Setting Oven Controls	16	Before You Call	66
Setting Oven Controls	24	Warranty	69
Before Using Microwave	49		

This manual is your resource for the use and care of your product. Please read it before using your appliance. Keep it handy for quick reference. If something doesn't seem right, the troubleshooting section will help you with common issues.

Visit Owner Support on ElectroluxAppliances.com for access to FAQs, how-to videos and articles, accessories and cleaning products.

We are here for you! Visit our website, chat with an agent, or call us if you need help. If you do need service, we can get that started for you.

For Peace of Mind Protection, register your product. Locate your registration card and/or label on your product with the photo register icon.

Keep your product info here so it's easy to find.

Model Number:

Serial Number:

Purchase Date:



INSTALLATION CHECKLIST

- Read all the safety instructions in the front of your Use & Care Manual.
- Remove all packaging materials from your appliance before cooking.
- Confirm that the electrical power to the appliance is turned on.
- Wipe out the inside of the oven cavity with a damp cloth.
- Apply a thin layer of cooking oil to the sides of the oven racks to keep them gliding smoothly.
- Set the clock. See (page 18) for instructions.
- Before cooking, set the oven to bake at 350°F (177°C) for 30 minutes (page 26). Some noise and odors are normal on the first cooking cycle.
- Remember to complete your product registration!

Read all instructions before using this appliance.

This manual contains important safety symbols and instructions. Please pay attention to these symbols and follow all instructions given.

Do not attempt to install or operate your appliance until you have read the safety precautions in this manual. Safety items throughout this manual are labeled with a WARNING or CAUTION statement based on the risk type.

Warnings and important instructions appearing in this guide are not meant to cover all possible conditions and situations that may occur. Common sense, caution, and care must be exercised with installing, maintaining, or operating your appliance.

DEFINITIONS

 This is the safety alert symbol. It is used to alert of potential personal injury hazards. Obey all safety messages that follow this symbol to avoid possible injury or death.

WARNING

Indicates a potentially hazardous situation which, if not avoided, may result in death or serious injury.

CAUTION

Indicates a potentially hazardous situation which, if not avoided, may result in minor or moderate injury.

IMPORTANT

Indicates installation, operation or maintenance information which is important but not hazard-related.

NOTE

Indicates a short, informal reference – something written down to assist the memory or for future reference.

WARNING

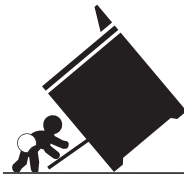

Tip Over Hazard

- **A child or adult can tip the oven and be killed.**
- **Install the anti-tip device to oven and/or structure per installation instructions.**
- **Ensure the anti-tip device is re-engaged when the oven is moved.**
- **Do not operate the oven without the anti-tip device in place and engaged.**
- **Failure to follow these instructions can result in death or serious burns to children and adults.**

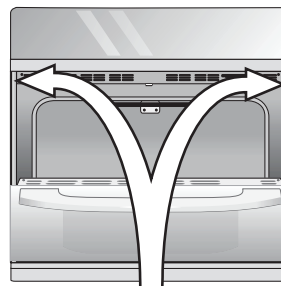

Refer to the installation instructions supplied with your appliance for proper installation.

Anti-tip mounting holes

Check for proper installation with a visual check that the anti-tip screws are present. Test the installation with light downward pressure on the open oven door. The oven should not tip forward.

4

IMPORTANT SAFETY INSTRUCTIONS

PRECAUTIONS TO AVOID POSSIBLE EXPOSURE TO EXCESSIVE MICROWAVE ENERGY

For your safety, the information in this manual must be followed to minimize the risk of fire or explosion or to prevent property damage, personal injury or loss of life. Adhere to the following precautions:

- DO NOT attempt to operate the microwave oven with the door open since open-door operation can result in harmful exposure to microwave energy. It is important not to defeat or tamper with the safety interlocks.
- DO NOT place any object between the microwave oven front face and the door or allow soil or cleaner residue to accumulate on sealing surfaces.
- DO NOT operate the microwave oven if it is damaged. It is particularly important that the oven door close properly and that there is no damage to the: (1) door (bent), (2) hinges and latches (broken or loosened), (3) door seals and sealing surfaces.
- The microwave oven should not be adjusted or repaired by anyone except properly qualified service personnel.

IMPORTANT INSTRUCTIONS FOR UNPACKING AND INSTALLATION



IMPORTANT

Read and follow the below instructions and precautions for unpacking, installing, and servicing your appliance.

Remove all tape and packaging before using the appliance. Destroy the carton and plastic bags after unpacking the appliance. Never allow children to play with packaging material. Do not remove the wiring label and other literature attached to the appliance. Do not remove model/serial number plate.

Cold temperatures can damage the electronic control. When using this appliance for the first time, or when the appliance has not been used for an extended period of time, be sure the appliance has been in temperatures above 32°F (0°C) for at least 3 hours before turning on the power to the appliance.

All materials used in construction of cabinets, enclosures, and supports surrounding the product must have a temperature rating above 194°F (90°C).

Never modify or alter the construction of the appliance by removing the leveling legs, panels, wire covers, anti-tip brackets/screws, or any other part of the appliance.

Be sure to have an appropriate foam-type fire extinguisher available, visible, and easily accessible located near the appliance.

GROUNDING INSTRUCTIONS

! WARNING

- Avoid fire hazard or electrical shock. Failure to follow this warning may cause serious injury, fire, or death.
- Avoid fire hazard or electrical shock. Do not use an adapter plug, use an extension cord, or remove grounding prong from the power cord. Failure to follow this warning may cause serious injury, fire, or death.

Proper Installation—Be sure your appliance is properly installed and grounded by a qualified technician. In the United States, install in accordance with the National Fuel Gas Code ANSI Z223.1/NPFA No. 54, latest edition and National Electrical Code NFPA No. 70 latest edition, and local electrical code requirements. In Canada, install in accordance with CAN/CGA B149.1 and CAN/CGA B149.2 and CSA Standard C22.1, Canadian Electrical code, Part 1-latest editions and local electrical code requirements. Install only per installation instructions provided in the literature package for this appliance.

For personal safety, this appliance must be properly grounded. For maximum safety, the power cord must be securely connected to an electrical outlet or junction box that is the correct voltage, is correctly polarized and properly grounded, and protected by a circuit breaker in accordance with local codes.

It is the personal responsibility of the consumer to have the appropriate outlet or junction box with the correct, properly grounded wall receptacle installed by a qualified electrician. It is the responsibility and obligation of the consumer to contact a qualified installer to assure that the electrical installation is adequate and is in conformance with all local codes and ordinances.

See the installation instructions packaged with this appliance for complete installation and grounding instructions.

IMPORTANT INSTRUCTIONS FOR USING THE APPLIANCE

! WARNING

- Storage In or On Appliance—Flammable materials should not be stored in an oven or microwave, near surface burners or elements, or in the storage or warmer drawer (if equipped). This includes paper, plastic, and cloth items, such as cookbooks, plastic ware, and towels, as well as flammable liquids. Do not store explosives, such as aerosol cans, on or near the appliance.
- Do not leave children alone - Children should not be left alone or unattended in the area where appliance is in use. They should never be allowed to sit or stand on any part of the appliance, including the storage drawer, lower broiler drawer, warmer drawer, or lower double oven.
- Do not store items of interest to children in the cabinets above the appliance or on the backguards of ranges. Children climbing on or near the appliance to reach items could be seriously injured.
- Do not allow children to climb or play around the appliance. The weight of a child on an open oven door may cause the appliance to tip, resulting in serious burns or other injury. An open drawer when hot may cause burns.

6

IMPORTANT SAFETY INSTRUCTIONS



WARNING

- Stepping, leaning, or sitting on the door or drawers of this appliance can result in serious injuries and also cause damage to the appliance.
- Never cover any slots, holes or passages in the oven bottom or cover and entire rack with materials such as aluminum foil. Aluminum foil linings may also trap heat, causing a fire hazard.
- Do not use oven or warmer drawer (if equipped) for storage.
- Never use your appliance as a space heater to heat or warm the room. Doing so may result in carbon monoxide poisoning and overheating of the appliance.



CAUTION

- When heating fat or grease, watch it closely. Grease may catch fire if it becomes too hot.
- Do not use water or flour on grease fires. Smother fire or flame or use dry chemical or foam-type extinguisher. Cover the fire with a pan lid or use baking soda.
- Use dry potholders. Moist or damp potholders on hot surfaces may result in burns from steam. Do not let potholders touch hot cooking areas. Do not use towels or other bulky cloths.
- Do not heat unopened food containers - Build-up of pressure may cause container to burst and result in injury.



CAUTION

- Wear proper apparel - Loose-fitting or hanging garments should never be worn while using the appliance. Do not let clothing or other flammable materials contact hot surfaces.
- Do not touch surface burners or elements, areas near these burners or elements, interior surfaces of the oven, or the warmer drawer (if equipped). Surface burners and elements may be hot even though they appear cool. Areas near surface burners and elements may become hot enough to cause burns. During and after use, do not touch, or let clothing or other flammable materials touch these areas until they are cool. These areas may include the cooktop, surfaces facing the cooktop, oven vent areas, oven door, and oven window.
- Do not attempt to operate the appliance during a power failure. If the power fails, always turn off the appliance. If the appliance is not turned off and the power resumes, electric surface elements may resume operation when power is restored. Once the power resumes, reset the clock and the oven function.

IMPORTANT INSTRUCTIONS FOR USING YOUR OVEN

Protective liners—Do not use aluminum foil, aftermarket oven liners, or any other materials or devices to line oven bottom, oven racks, or any other part of the appliance. Only use aluminum as recommended for baking, such as lining cookware or as a cover placed on food. Any other use of protective liners or aluminum foil may result in a risk of electric shock or fire or a short circuit.

Use care when opening oven door, lower oven door, or warmer drawer (some models). Stand to the side of the appliance when opening the door of a hot oven. Let hot air or steam escape before you remove or replace food in the oven.

Keep oven vent ducts unobstructed. Touching surfaces in this area when the oven is on may cause severe burns. Do not place plastic or heat-sensitive items on or near the oven vent. These items can melt or ignite.

Placement of oven racks - Always place oven racks in desired location while oven is cool. If rack must be moved while oven is hot, do not let potholder contact hot burner or element in oven. Use potholders and grasp the rack with both hands to reposition. Remove all cookware and utensils before moving the rack.

Do not use a broiler pan without its insert. Broiler pans and inserts allow dripping fat to drain away from the high heat of the broiler. Do not cover the broiler insert with aluminum foil; exposed fat and grease could ignite.

Do not cook food on the oven bottom. Always cook in proper cookware and always use the oven racks.

IMPORTANT INSTRUCTIONS FOR USING YOUR MICROWAVE OVEN

 **WARNING**

When using electrical appliances, basic safety precautions should be followed to reduce the risk of burns, electric shock, fire, injury to persons, or exposure to excessive microwave energy.

Read all instructions before using the appliance.

Read and follow the specific PRECAUTIONS TO AVOID POSSIBLE EXPOSURE TO EXCESSIVE MICROWAVE ENERGY.

Install or locate this appliance only in accordance with the provided installation instructions.

Some products such as whole eggs and sealed containers - for example, closed jars - are able to explode and should not be heated in this microwave oven.

Use this appliance only for its intended use as described in this manual. Do not use corrosive chemicals or vapors in this appliance. This type of microwave oven is specifically designed to heat, cook, or dry food. It is not designed for industrial or laboratory use.

As with any appliance, close supervision is necessary when used by children or infirm persons.

This appliance, including power cord, must be serviced only by qualified service personnel. Contact nearest authorized servicer for examination, repair, or adjustment.

Do not cover or block any vents or openings on the microwave oven.

Do not store or use this appliance outdoors.

8

IMPORTANT SAFETY INSTRUCTIONS

Do not use this product near water - for example: near a kitchen sink, in a wet basement, near a swimming pool, or similar locations.

Oversized foods or oversized metal utensils should not be inserted in a microwave oven as they may create a fire or risk of electric shock.

Do not clean with metal scouring pads. Pieces can burn off the pad and touch electrical parts, involving a risk of electric shock.

Do not use paper products when appliance is operated in the convection or mix mode (some models).

Do not cover racks (if equipped) or any other part of the microwave oven with metal foil. This will cause overheating of the microwave oven.

Review the door cleaning instructions in the operating instructions.



CAUTION

To reduce the risk of fire in the microwave oven cavity, take the following precautions:

Do not overcook food. Carefully attend to the appliance when paper, plastic or other combustible materials are placed inside the microwave oven to facilitate cooking.

Remove wire twist-ties from paper or plastic bags before placing bags in the microwave oven.

If materials inside the microwave oven ignite, keep oven door closed, turn oven off, and disconnect the power cord or shut off power at the fuse or circuit breaker panel.

Do not use microwave oven cavity for storage purposes.

Do not leave paper products, cooking utensils, or food in the cavity when not in use.

Liquids such as water, coffee, or tea are able to be overheated beyond the boiling point without appearing to be boiling. Visible bubbling or boiling when the container is removed from the microwave oven is not always present. This could result in very hot liquids suddenly boiling over when a spoon or other utensil is inserted into the liquid.

To reduce the risk of injury to persons from boiling liquids:

Do not overheat the liquid.

Stir the liquid both before and halfway through heating it.

Do not use straight-sided containers with narrow necks. Use wide-mouthed containers.

After heating, allow the container to stand in the microwave oven at least 20 seconds before removing.

Use extreme care when inserting spoons or other utensils into the container.

If the microwave oven light fails, consult an authorized servicer.

IMPORTANT INSTRUCTIONS FOR CLEANING YOUR APPLIANCE

CAUTION

Before manually cleaning any part of the appliance, be sure all controls are turned off and the appliance is cool. Cleaning a hot appliance can cause burns.

Clean the appliance regularly to keep all parts free of grease that could catch fire. Do not allow grease to accumulate. Greasy deposits in the fan could catch fire.

Always follow the manufacturer's recommended directions for use of kitchen cleaners and aerosols. Be aware that excess residue from cleaners and aerosols may ignite causing damage and injury.

Clean ventilating hoods frequently - Grease should not be allowed to accumulate on hood or filter. Follow the manufacturer's instructions for cleaning vent hoods.

IMPORTANT INSTRUCTIONS FOR SELF CLEANING OVENS

CAUTION

Before using self clean, remove the broiler pan, any food, utensils, and cookware from the oven, storage drawer or warming drawer (if equipped). Remove oven racks unless otherwise instructed.

Do not clean the oven door gasket. The door gasket is essential for a good seal. Care should be taken not to rub, damage, or move the gasket.

Do not use a protective coating to line the oven and do not use commercial oven cleaner unless certified for use in a self-cleaning oven.

Use the self clean cycle to clean only the parts listed in this manual.

Some birds are extremely sensitive to the fumes given off during the self clean cycle of any oven. Move birds to another well-ventilated room.

IMPORTANT INSTRUCTIONS FOR SERVICE AND MAINTENANCE

Do not repair or replace any part of the appliance unless specifically recommended in the manuals. All other servicing should be done only by a qualified technician. This reduces the risk of personal injury and damage to the appliance.

Always contact your dealer, distributor, service agent, or manufacturer about problems or conditions you do not understand.

Ask your dealer to recommend a qualified technician and an authorized repair service. Know how to disconnect the power to the appliance at the circuit breaker or fuse box in case of an emergency.

Remove the oven door from any unused oven if it is to be stored or discarded.

Do not touch a hot oven light bulb with a damp cloth. Doing so could cause the bulb to break. Handle halogen lights (if equipped) with paper towels or soft gloves. Disconnect the appliance or shut off the power to the appliance before removing and replacing the bulb.

10 IMPORTANT SAFETY INSTRUCTIONS

Federal Communications Commission Radio Frequency Interference Statement (USA only)
This equipment generates and used ISM frequency energy and if not installed and used properly, that is in strict accordance with the manufacturer's instructions, may cause interference to radio and television reception. It has been type tested and found to comply with limits for ISM Equipment pursuant to part 18 of FCC Rules, which are designed to provide reasonable protection against such interference in a residential installation. However, there is no guarantee that interference will not occur in a particular installation. If this equipment does cause interference to radio or television reception, which can be determined by turning the equipment on and off, the user is encouraged to try to correct the interference by one or more of the following:

- Reorient the receiving antenna of the radio or television.
- Relocate the microwave oven with respect to the receiver.
- Move the microwave oven away from the receiver.
- Plug the microwave oven into a different outlet so that the microwave oven and the receiver are on different branch circuits. The manufacturer is not responsible for any radio or television interference cause by unauthorized modification to this microwave oven. It is the responsibility of the user to correct such interference.

WARNING

Remote Operation - This appliance is configurable to allow remote operation at any time. Do not store any flammable materials or temperature sensitive items inside, on top, or near surface units of the appliance.

WARNING

California Residents: for cancer and reproductive harm information, visit www.P65Warnings.ca.gov

Special Features

Use the special features of your Electrolux oven to get the best baking and roasting results.

Goal	Feature
<ul style="list-style-type: none"> • Steaks perfectly cooked to your preference • Juicy pork and poultry • Eggs just as hard or soft as you like them • Vegetables that remain firm and crisp 	<p>Air Sous Vide</p> <p>The precisely-controlled heat and airflow give you sous vide results without the water bath, preserving natural flavors and locking in moisture.</p>
<ul style="list-style-type: none"> • Breads and pastries that rise higher with a crispy, golden crust and a light and flaky interior 	<p>Steam Bake</p> <p>Steam baking slows the formation of the crust, allowing your dough to grow longer before the crust forms.</p>
<ul style="list-style-type: none"> • Moist and tender meats with a golden, crispy skin on the outside. 	<p>Steam Roast</p> <p>The humidity of steam roasting prevents meats from drying out during the cooking process.</p>
<ul style="list-style-type: none"> • Golden, crispy chicken wings • Crunchy vegetable chips • Juicy chicken parmesan • Perfectly crisp tempura shrimp, samosas, and more 	<p>Air Fry</p> <p>The hot air convection makes crisp, golden fried foods without the splatter. For even heating on all sides and large capacity, use the Air Fry Tray (included).</p>
<ul style="list-style-type: none"> • Airy breads and balanced pizza dough 	<p>Bread Proof</p> <p>Bread proofing keeps your oven at the best temperature and humidity for yeast to cause your dough to rise.</p>
<ul style="list-style-type: none"> • Prepare convenience foods without delay 	<p>No Preheat</p> <p>Get your culinary delights on the table faster</p>
<ul style="list-style-type: none"> • Healthy, flavorful fruit snacks • Lean meat jerky • Dried herbs 	<p>Dehydrate</p> <p>The dehydrate feature keeps the oven on low humidity and low heat to dry foods without cooking them.</p>
<ul style="list-style-type: none"> • Perfectly browned baked goods • Evenly cooked roasts and braises 	<p>Advanced Convection</p> <p>Even your most challenging recipes turn out delicious with the precisely-controlled heat and air circulation of Advanced Convection</p>
<ul style="list-style-type: none"> • Leave the guesswork out of achieving the perfect temperature 	<p>Food Probe</p> <p>Cook your proteins to the exact internal temperature you desire, preventing under- or over-cooking</p>
<ul style="list-style-type: none"> • Roast turkey that's crispy on the outside and juicy on the inside. 	<p>Turkey Option</p> <p>Precisely times your convection roast for turkey that is perfectly done.</p>



12

COOKING RECOMMENDATIONS

Goal	Feature
<ul style="list-style-type: none">• Set, preheat, and monitor cook time remotely• Get alerts and even switch to “keep warm” mode to ensure dishes are all ready at the same time	Electrolux Connect Technology Even your most challenging recipes turn out delicious with the precisely-controlled heat and air circulation
<ul style="list-style-type: none">• Easily find the feature you need for your cooking task	Full-Color Touch Controls Operate your oven with ease with our intuitive Full-Color Touch Controls
<ul style="list-style-type: none">• Move food easily in and out of the oven	Luxury-Glide® Oven Racks Oven racks are so smooth they extend effortlessly
<ul style="list-style-type: none">• See clearly what’s happening inside the oven	Luxury-Design® Lighting Get full visibility into the oven’s interior with our ramp-up halogen Luxury-Design® Lighting
<ul style="list-style-type: none">• Prevent build-up of burned, spilled food in the bottom of the oven	One Hour Steam Clean Keep your oven looking its best with the one hour Steam Clean cycle that’s chemical- and odor-free

Bakeware

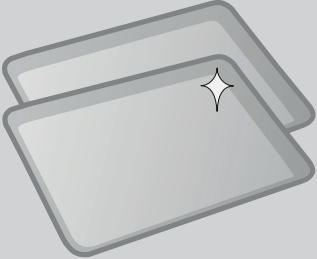
The material of bakeware affects how evenly and quickly it transfers heat from the pan to the food.

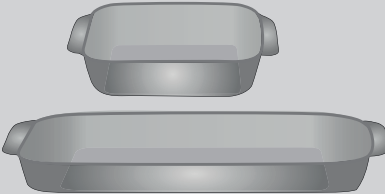
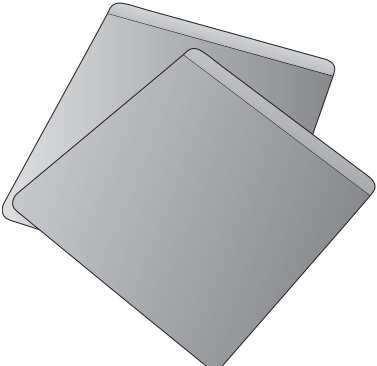
Material	Attributes	Recommendation
<p>Shiny metal bakeware</p> 	<p>Shiny, aluminum, and non-coated bakeware is the best for even heating. It is suitable for all baked goods.</p>	<p>Recommended cooking temperatures and times are based on shiny metal bakeware.</p>
<p>Dark metal bakeware</p> 	<p>Dark bakeware cooks hotter than shiny bakeware.</p>	<p>Reduce the cooking temperature by 25°F (13-14°C) when using dark bakeware.</p>
<p>Glass bakeware</p> 	<p>Glass bakeware cooks hotter than shiny bakeware.</p> <p>Glass is convenient, as the same piece of bakeware can be used for cooking, serving, and storing food.</p>	<p>Reduce the cooking temperature by 25°F (13-14°C) when using glass bakeware.</p>
<p>Insulated bakeware</p> 	<p>Insulated bakeware cooks cooler than shiny bakeware.</p> <p>Insulated bakeware is designed for baking in gas ovens.</p>	<p>When using insulated bakeware the recipe baking time may be longer than usual.</p>

14 COOKING RECOMMENDATIONS

Cooking Conditions

Conditions in your kitchen can affect the performance of your appliance when cooking food.

Condition	Attributes	Recommendation
Aging cookware	As pans age and become discolored, cooking times may need to be reduced slightly.	If food is too dark or overcooked, use the minimum cook time in the recipe or packaging. If food is too light or undercooked, use the middle to maximum cook time in the recipe or packaging.
High altitude	Air is drier and air pressure is lower. Water boils at a lower temperature, and liquids evaporate faster. Foods may take longer to bake. Doughs may rise faster.	Adjust cooking temperature, cooking time, or recipes as needed. Increase amount of liquid in baking recipes. Increase cook time on cooktop. Cover dishes to reduce evaporation. Increase bake time or oven temperature. Reduce amount of baking soda or baking powder in recipe. Reduce rising time or punch down dough and allow it to rise twice.

Cooking Results

Small adjustments may help you achieve the best results.

Result	Recommendation
Food too light	Use the middle to maximum cook time recommended on packaging or recipe.
Food too dark	Use the minimum cook time recommended on packaging or recipe.

Cooking Tips

Use these additional tips to get the best results from your appliance.

Situation	Recommendation
Baking	
Rack placement	Follow the instructions in particular oven mode starting in "Setting Oven Controls" on page 24.
Preheat	Fully preheat the oven before baking items like cookies, cakes, biscuits and breads. Insert food immediately after the beep.
Checking food	Use the window and oven light when checking food. Opening the door may reduce baking performance.
Bake or Convection Bake	Convection bake is the best function to use for baking on multiple racks. For best performance, see "Convection Bake" on page 30
Steam Bake	For directions, tips, and benefits of Steam Bake see "Steam Bake" on page 41.
Food placement	Allow at least 2 inches (5 cm) of space between bakeware for proper air circulation.

Material	Recommendation
Broiling / Roasting	
Broiling pan	For best results when broiling, use a broil pan with an insert designed to drain the fat from the food, help avoid spatter, and reduce smoking. The broiler pan will catch grease spills, and the insert helps prevent grease splatters.
Convection Cooking	
Convection attributes	<p>Convection cooking uses a fan to circulate hot air around the oven and food. It browns food more evenly and reduces hot spots in the oven.</p> <p>Convection saves time when using multiple racks or cooking several food items at once.</p>
Convection bake	<p>Reduce cooking temperature by 25° F (13-14° C) from the recipe unless the recipe is written for convection baking.</p> <p>Preheat the oven for best results.</p>
Convection roast	<p>Convection roast is best for meats and does not require preheating for most meats and poultry.</p> <p>Reducing the cooking temperature for convection roast is not recommended. Carefully follow your recipe's temperature and time recommendations, adjusting the cooking time if the recipe does not specify convection roasting time.</p> <p>Since convection roast cooks faster, cook time may be reduced by 25% to 40% depending on food type. You can reduce cook times by 25% from the recommended time of your recipe, and check the food at this time. If needed, continue cooking until the desired doneness is obtained.</p> <p>Use the meat probe included with your appliance. Meat probes are also available from most grocery and home goods stores.</p> <p>Arrange oven racks so large cuts of meat and poultry are on the lowest rack of the oven.</p> <p>Do not cover foods when dry roasting - covering will prevent the meat from browning properly.</p> <p>When cooking meats, use the broiler pan and insert or a roasting rack. The broiler pan will catch grease spills and the insert helps prevent grease splatters.</p>

16 BEFORE SETTING OVEN CONTROLS

➔ IMPORTANT

Your Electrolux wall oven has many features that allow you to customize the way your oven works.

Take time to read this section for important safety information and to become familiar with the many menu option settings starting on page 18.

Oven Vent Location

The oven is vented as shown below. When the oven is on, warm air is released through the vent. This venting is necessary for proper air circulation in the oven and good baking results. Do not block oven vent. Never close off the openings with aluminum foil or any other material. Steam or moisture may appear near the oven vent. This is normal.

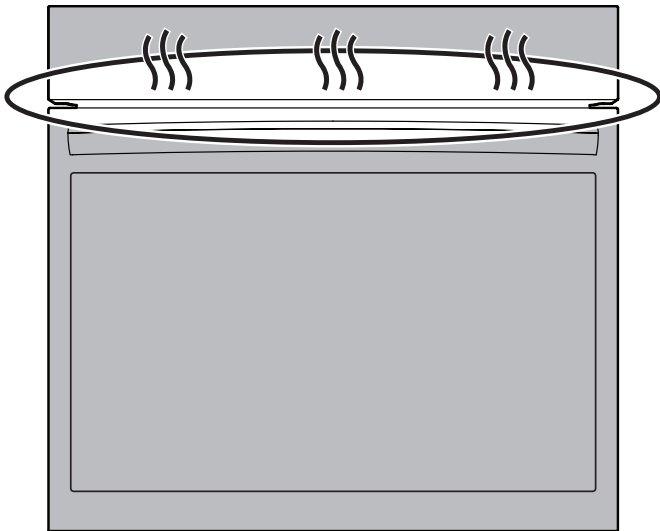

Figure 1: Oven vent

⚠ WARNING

Protective Liners – Do not use aluminum foil or any other material or liners to line the oven bottom, walls, racks or any other part of the range. Doing so will alter the heat distribution, produce poor baking results, and possibly cause permanent damage to the oven interior. Improper installation of these liners may result in risk of electric shock or fire. During self clean, temperatures in the oven will be hot enough to melt foil.

⚠ CAUTION

Always use pot holders or oven mitts when using the oven. When cooking, the oven interior, oven exterior, oven racks, and cooktop will become very hot which can cause burns.

Remove all oven racks before starting a self clean cycle. If oven racks are left inside the oven during a cleaning cycle, the slide ability of the oven racks may be damaged and all of the oven racks will lose their shiny finish.

To prevent possible damage to the oven, do not attempt to close the oven door until all the oven racks are fully positioned back inside the oven cavity.

Types of Oven Rack

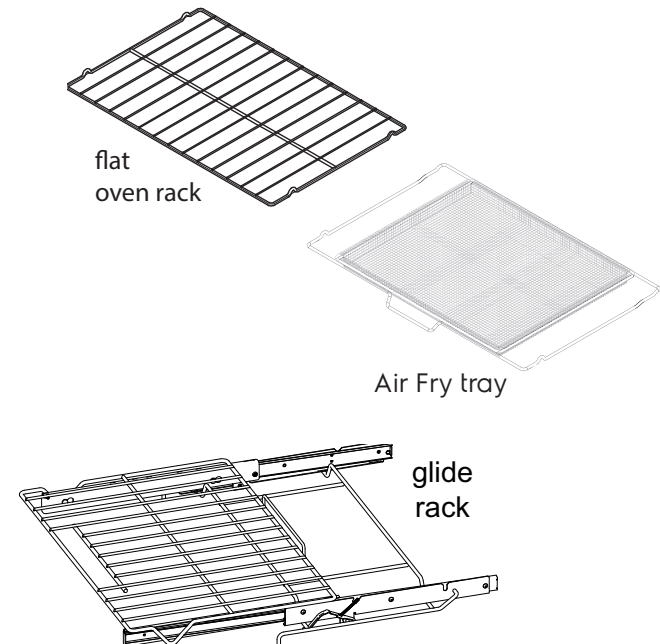

Figure 2: Oven rack types

- **Flat oven racks** may be used for most cooking needs and may be placed in most oven rack positions.
- The fully extendable **glide rack** makes food preparation easier. This oven rack has glide tracks that allow the rack to be pulled away from the oven without rubbing the sides of the oven wall. See glide rack instructions on next page.

**WARNING**

Do not line the oven walls, racks, bottom or any other parts of the range with aluminum foil. Doing so will alter heat distribution, produce poor baking results and may cause permanent damage to the oven interior. During self-clean temperatures the oven will be hot enough to melt foil.

Removing and Replacing the Glide Racks

The fully extendable Glide rack makes food preparation easier. This oven rack has glide tracks that allow the rack to be pulled away from the oven without rubbing the sides of the oven wall.

To remove - Make sure the baking rack is in the closed position. Using one hand, reach through handle opening and grasp both the upper and lower bars of the glide rack.

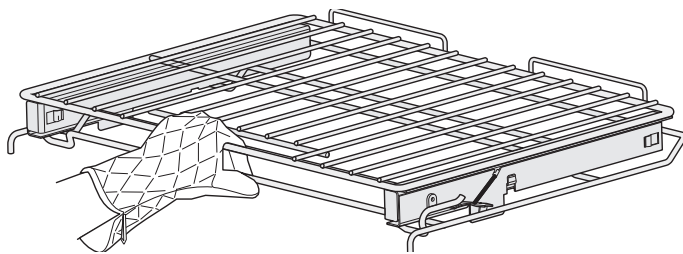

While holding both sections, pull the glide rack out of the oven until the stop position is reached.

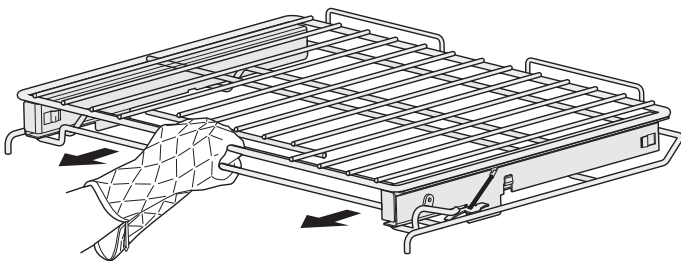

Using both hands, lift up the front of the rack slightly and continue to pull the rack away from the oven. Be sure to grasp both upper and lower rack portions together when removing or handling the glide rack.

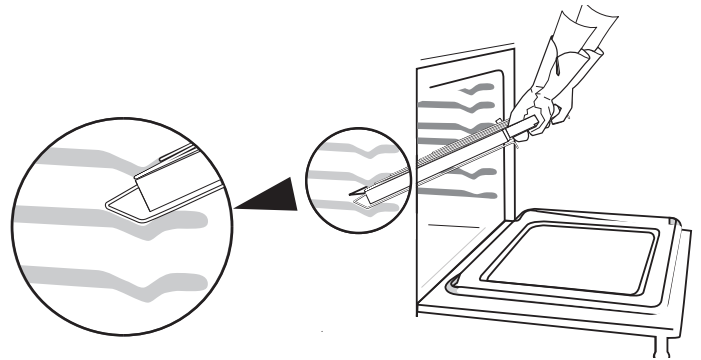

The rack portions move independently and are difficult to handle unless held together.

To replace - Make sure the baking rack is in the closed position. Grasp both upper and lower portions of glide rack. Lift and hold the rack level between the oven cavity walls. Tilt the front of the rack upward slightly and slide the rack completely into position.

To prevent possible damage to the oven, do not attempt to close the oven door until all the oven racks are fully positioned back inside the oven cavity.

**IMPORTANT**

Remove all oven racks and clean according to instructions provided in the Care & Cleaning section of this manual. Never pick up hot oven racks or parts.

18 BEFORE SETTING OVEN CONTROLS

Using Menu Options to Customize Your Cooking Experience

When you first install your appliance, the screen will prompt you to set your preferences. You can always change them later using the menu ☰

1. Touch Menu Options bars and scroll to find the desired option.
2. Select option and set your preference.
3. Save and go back or Save & Close.

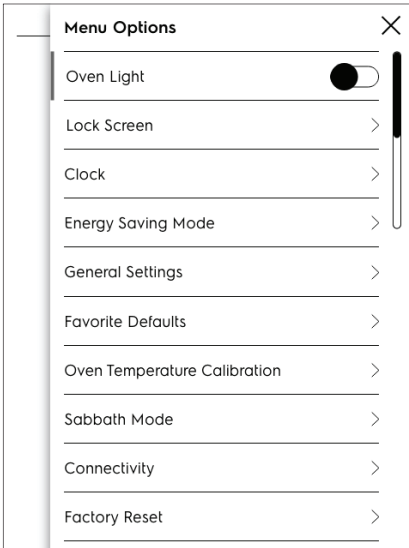

You can press the X to close without saving changes.

Clock

When the appliance is first plugged in or when the power supply to the appliance has been interrupted, the display will show 12:00. It is recommended to always set the clock for the correct time of day before using the appliance.

1. Touch **Menu Options** bars and scroll to **Clock**
2. Touch **Set Clock** and set time using graph.
3. Set 12 or 24 Hr
4. Set AM or PM
5. Save & Close

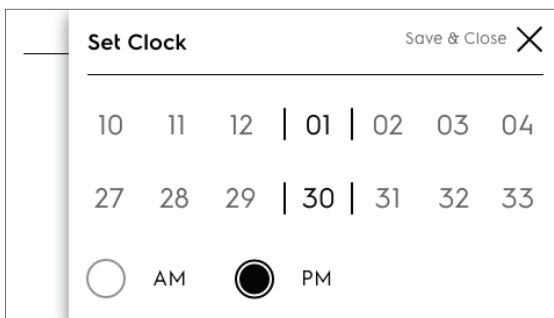

Energy Saving Mode

The oven control has a factory preset built-in 12-Hour Energy Saving feature that will turn off the oven if the oven is left on for more than 12 hours. The control may be programmed to override this feature to bake continuously.

1. Scroll to **Energy Saving Mode** and touch.
2. Follow the information to override the Energy Saving feature if necessary.
3. Save & Close.

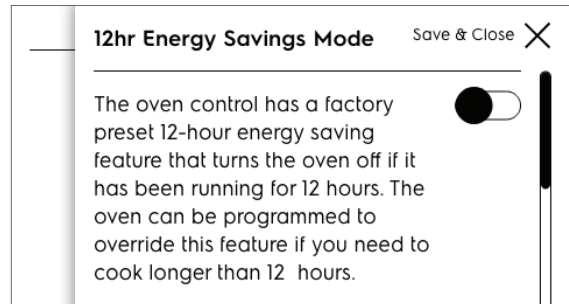

General Settings

1. Scroll to **General Settings** and touch.
2. Different options will appear.
3. Select an option to see how it is set and change if desired.

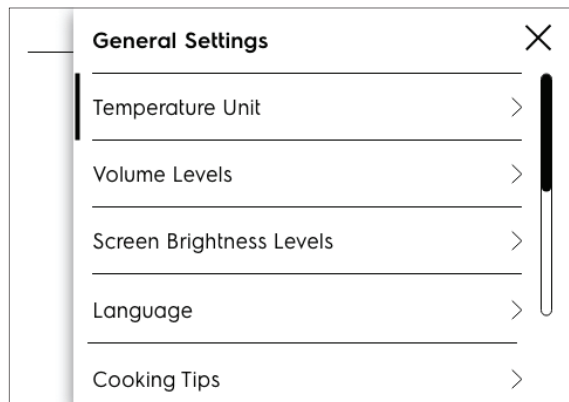

• Temperature Display

The electronic oven control is set to display °F when shipped from the factory. The display may be changed to show either °F or °C oven temperatures.

Temperature Display > F
 C

4. Select **F** or **C**
5. Save & Close

• Volume

Silent mode allows the oven control to operate without audible tones. Use the slider to set the volume.

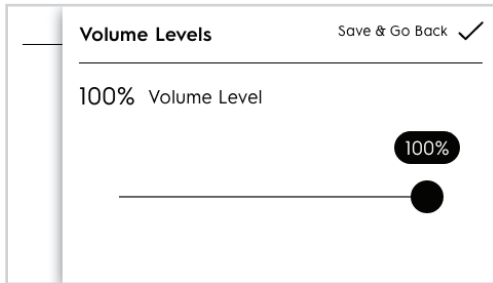

• Screen Brightness

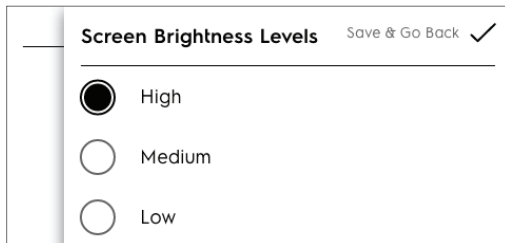

1. Choose brightness and Save & Close.

• Language



1. Select desired language
2. Save & Close

Favorites

Scroll to Favorites and touch.

- **Quick Start Options** > Oven 350°F (can change the default when Quick Start is selected.)

1. Change temperature if desired.
2. Save & Close.

- **Temperature Options** > Adjust Custom Preheat default

1. 325°F / 163°C
2. 375°F / 191°C
3. 400°F / 204°C

Smoke Shield

The Smoke Shield feature reduces smoke and odors during high-temperature cooking modes.

When selected, the Smoke Shield feature will operate on no preheat, convection roast, multi-rack, steam bake, and steam roast modes until the feature is toggled off. You may want to turn it off when cooking delicate items like pastries.

Smoke Shield is always active during self-clean, steam clean, air fry, and broil models.

Smoke Shield does not activate for bake, convection bake, air sous vide, dehydrate, or bread proof modes.

Oven Temperature Calibration

1. Scroll to Oven Temperature Calibration and touch.
2. Option to adjust is shown.
3. Use slide to increase or decrease default oven temperature.
4. Save and go back or Save & Close.

Read the important information before changing the oven temperature that was set at the factory.

Your appliance has been factory calibrated and tested to ensure an accurate baking temperature. For the first few uses, follow your recipe times and temperature recommendations carefully. If you think the oven is cooking too hot or too cool for your recipe times, you can adjust the control so the oven cooks hotter or cooler than the temperature displayed.

Important: Do not use oven thermometers such as those found in grocery stores to check the temperature settings inside your oven. These oven thermometers may vary as much as 20 to 40 degrees from actual temperatures.

The oven temperature may be increased as much as +35°F (+19°C) or decreased -35°F (-19°C) from the factory calibrated settings.

➔ NOTE

These temperature options are also available in Custom Preheat menu on the main screen

20 BEFORE SETTING OVEN CONTROLS

Sabbath Mode

1. Scroll to **Sabbath Mode**.
2. Read and follow all instructions to set and when finished cancel. See "Setting the Sabbath Feature for the Jewish Sabbath and Holidays (some models)" on page 43 for complete details on how Sabbath mode works with your oven controls.

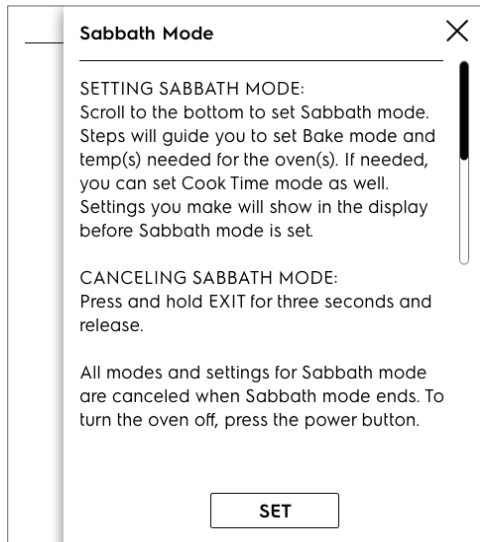

Factory Reset

1. Scroll to **Factory Reset** and touch
2. Follow screen prompts

Note: Your appliance was set with predetermined (default) oven control settings. Over time, users may have made changes to these settings. The following options may have been modified since the appliance was new:

- 12 or 24 hr display mode
- Screen Brightness
- Language
- Favorites
- Show Clock
- All Food Probe settings
- Continuous bake or 12 hour energy savings mode
- Silent or audible control
- Oven temperature display (Fahrenheit or Celsius)
- Oven temperature adjustments (UPO)

If Reset is touched all the settings will return to default

3. Are you sure?
4. Reset.
5. OKAY

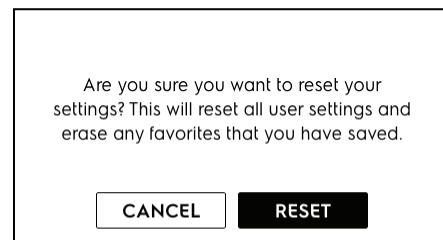

Food Probe

Food probe options can be found in setting menu and the oven modes menu.

1. Scroll to **Food Probe and touch.**
2. Follow instructions on the display.

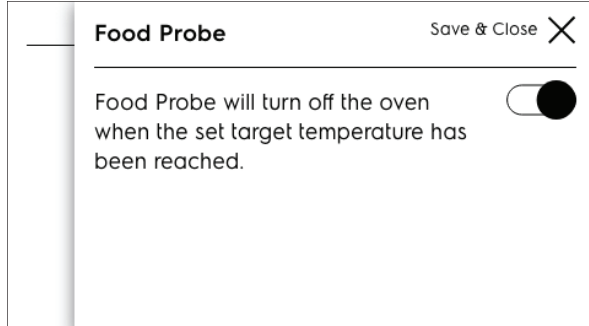

Door Lock and Screen Lock

As a safety measure the oven doors and controls can be locked. Follow screen directions to lock and unlock.

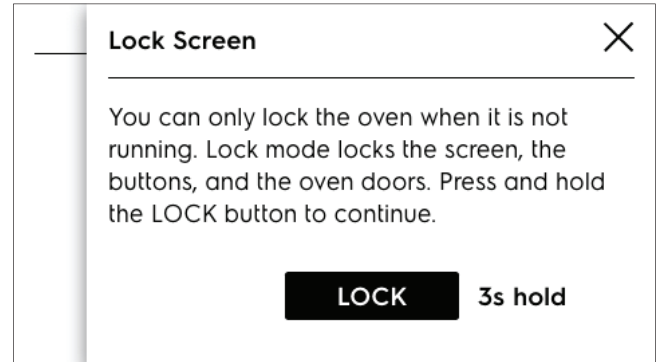

Touch and hold **LOCK** for 3 seconds. You will be shown a code to use for unlocking the doors and controls. This ensures that the oven will remain locked and safe.

When the doors and controls are locked the screen will show the time of day, a note that the oven is locked, and an **UNLOCK** key.

Once the controls and door is locked there is no access to any cooking functions. To unlock the oven door enter the code and press UNLOCK and follow directions on the screen.

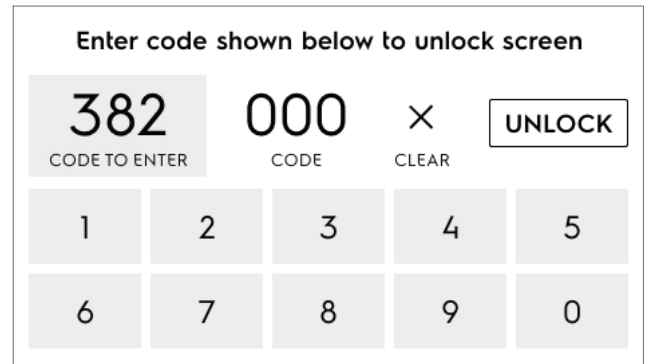

22 BEFORE SETTING OVEN CONTROLS

Connecting your oven to your smartphone



Download the Electrolux App to your smartphone to connect and to program your oven for remote cooking. Be sure to read the information in the Get Connected Card first before setting up your smartphone to connect to the oven.

In Menu Options scroll to **Connectivity** and select. Follow all instructions on the display.

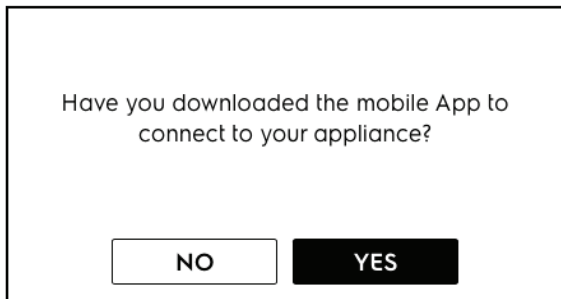

Once the App is downloaded you have options to connect to your home network. Be sure to read instructions and tips on using the App to set oven modes.

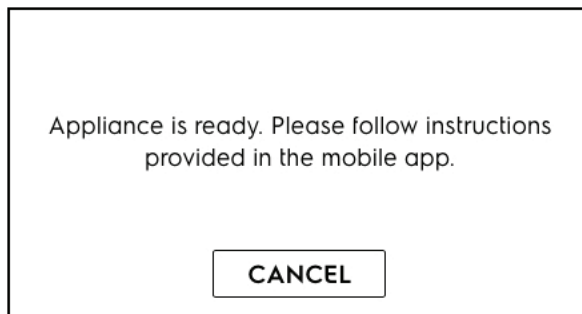
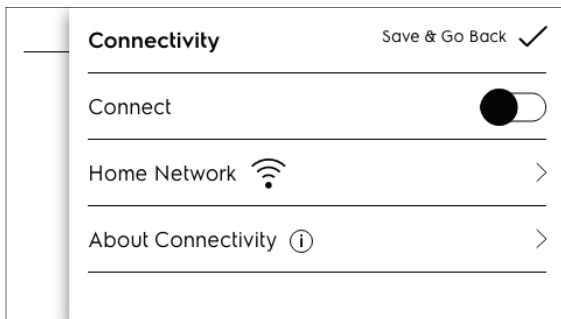

You can set the App to control some oven modes and functions remotely.

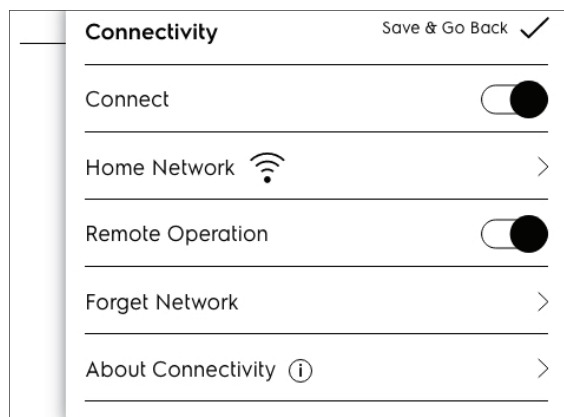

Using your smartphone to control some of the oven functions requires some care on your part. Be sure to follow all the Electrolux App instructions for mobile use.

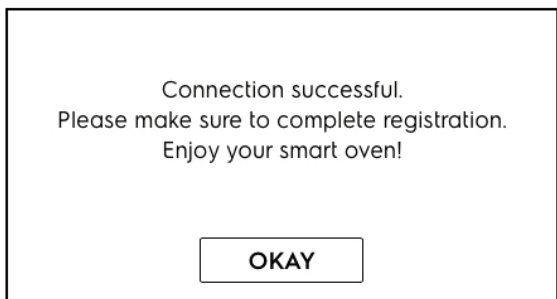

About the Appliance

1. Scroll to **About the Appliance** and touch.
2. Touch headings to see information.

Important information about the appliance such as the the software version number and contact information for support is listed here.

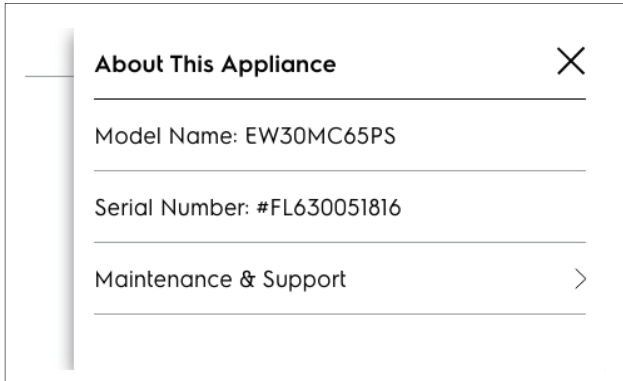

24 SETTING OVEN CONTROLS

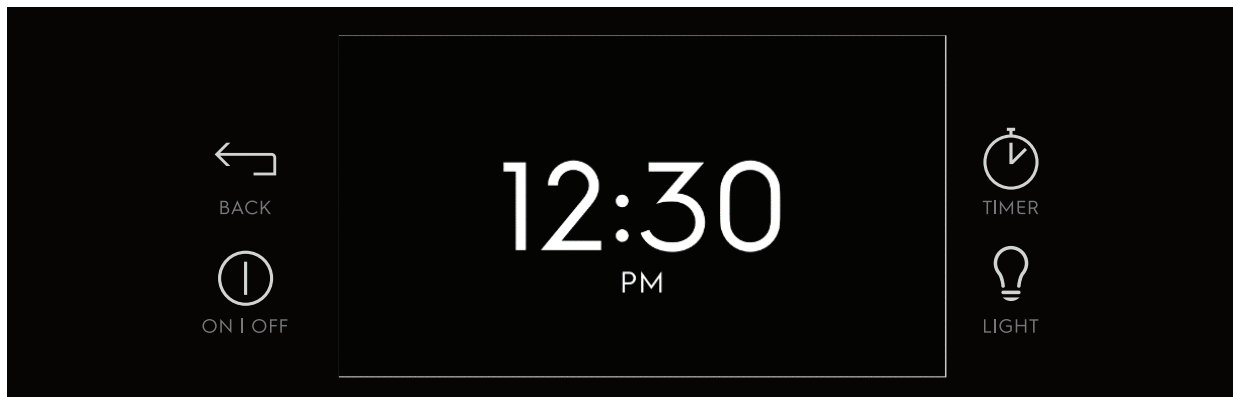

ON / OFF

When **ON/OFF** is pressed, the display opens to the Quick Start screen.

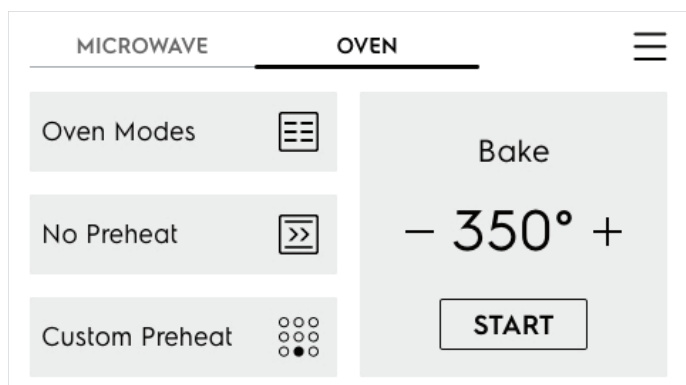

NOTE

In addition to ON/OFF, touching the screen will also activate the display.

If the oven is on when **ON/OFF** is pressed, it will turn off completely, canceling any functions that are running at the time.

BACK

Pressing the Back key will return to the previous screen without implementing any changes you may have selected.

TIMER

Pressing Timer will access the timer function. The timer will count down the amount of time you specify, and a tone will sound when the timer reaches zero. You can set a timer from 1 minute to 11 hours and 59 minutes.

Enter the desired time and press **START**. While the timer is running, you can pause or cancel the countdown. You can also add or subtract time by pressing + or -.

LIGHT

Press the Light key to turn the oven light on or off.

Table 1: Minimum and maximum control settings

Feature	Mode	Min Temp/Time	Max Temp/Time
No Preheat		170°F (77°C)	550°F (288°C)
Bake		170°F (77°C)	550°F (288°C)
Broil		400°F (205°C)	550°F (288°C)
Air Fry		170°F (77°C)	550°F (288°C)
Sous Vide		100°F (38°C)	205°F (94°C)
Steam Bake		215°F (102°C)	550°F (288°C)
Steam Roast		215°F (102°C)	550°F (288°C)
Conv Bake		170°F (77°C)	550°F (288°C)
Conv Roast		170°F (77°C)	550°F (288°C)
Food Probe		140°F (60°C)	210°F (99°C)
Keep Warm		140°F (60°C)	200°F (93°C)
Bread Proof		100°F (38°C)	11:59 Hr./Min
Dehydrate		95°F (35°C)	170°F (77°C)
Timer		0:01 Min	11:59 Hr./Min.
Clock Time	12 Hr.	1:00 Hr./Min.	11:59 Hr./Min.
	24 Hr	0:00 Min	23:59 Hr./Min.
Delay Start		0:01 Min.	1:00 Hr./Min.
Cook Time	12 Hr.	0:01 Min	11:59 Hr./Min.
	24 Hr	0:01 Min	11:59 Hr./Min.
Self clean		2 hours	4 hours

Quick Start

When **ON/OFF** is pressed the display opens to the Quick Start screen.

From the Quick Start screen, you can immediately start the Bake function by pressing **START**. You can adjust the temperature by pressing **+** or **-**.

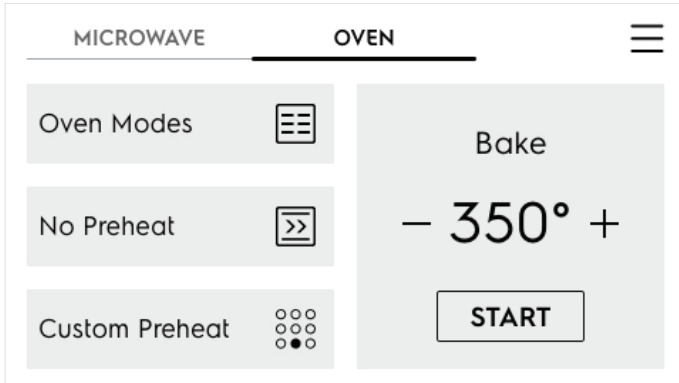

To select other cooking options, touch **Oven Modes** and scroll to the desired feature:

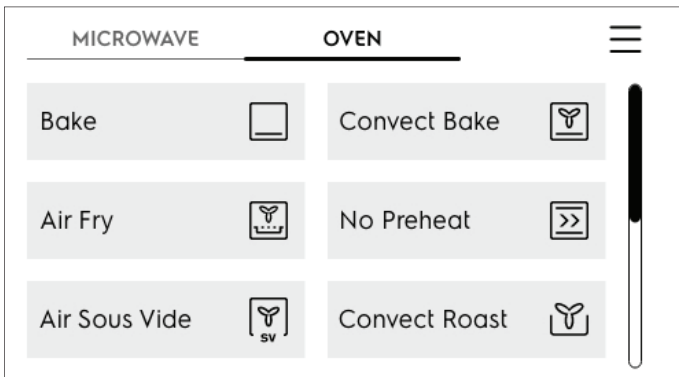

Use the scroll bar to find your oven mode as shown in the oven mode table on the right. When you select a cooking mode simply follow the tips for setting the particular mode.

Important: Valuable tips to help you get the best results are included in the display and also can be found in this Use & Care Manual.

Modes

- Bake (page 26)
- Convection Bake (page 30)
- Air Fry (page 29)
- No Preheat (page 28)
- Air Sous Vide (page 31)
- Convection Roast (page 36)
- Broil (page 34)
- Multi-Rack (page 40)
- Steam Bake (page 41)
- Steam Roast (page 42)
- Bread Proof (page 42)
- Keep Warm (page 43)
- Dehydrate (page 42)
- Delay Start (page 27)
- Food Probe (page 38)
- Self Clean (page 45)
- Steam Clean (page 48)

26 SETTING OVEN CONTROLS

Setting Bake

Bake uses heat that rises from the oven bottom for best baking results.

A reminder tone will sound indicating when the set bake temperature is reached and to place the food in the oven.

Bake may be set for any oven temperature between 170°F (77°C) to 550°F (288°C).

CAUTION

Always use pot holders or oven mitts when using the oven. When cooking the oven interior, oven racks, and cooktop will become very hot which can cause burns.

Baking Tips

- Fully preheat the oven before baking items like cookies, cakes, biscuits and breads.
- For all baking except layer cakes, pans should be placed in the center of the rack. Place layer cake pans as shown.
- Use the convection bake function for best results when baking cookies or cakes on multiple racks.
- For best results when baking layer cakes using two oven racks, place racks in positions 2 (flat) and 4 (glide) and place pans as shown.
- When using any single rack for baking cookies, cakes, biscuits, or muffins use rack position 3.
- Allow at least 2 inches (5 cm) of space between bakeware for proper air circulation.
- Leave oven lights off while baking.

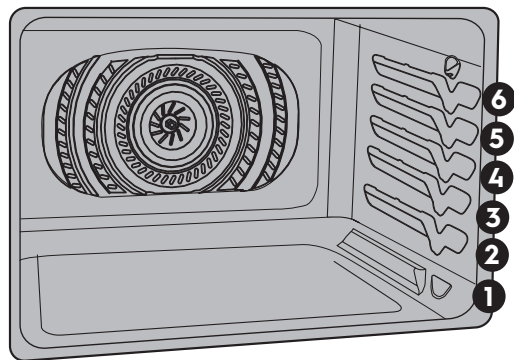

To set Bake

1. Press **ON/OFF** key.

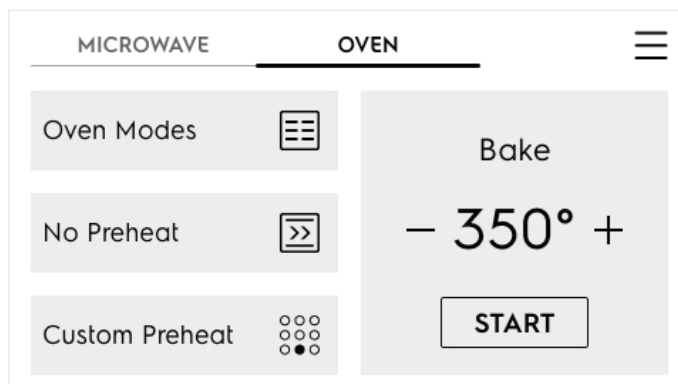

2. Touch **Oven Modes** and touch **Bake**. The default temperature 350°F will show in the display. You can also use the controls on the Quick Start screen.
3. To set the temperature to 375, use the numbered keys to program the new temperature of 375 and touch **START**.
4. The screen shows the current temperature and a **Cook Time** button.
5. Touch **Cook Time** to set a cooking time if needed.
NOTE: If a cook time is set, the oven will turn off automatically when the time expires.
6. Touch **START**.
7. Cooking has ended and **Off** will be in display. Press **OKAY** to return to the start screen.

Press **ON/OFF** to turn off the oven and show time of day in the display.

To cancel cooking anytime touch **CANCEL**.

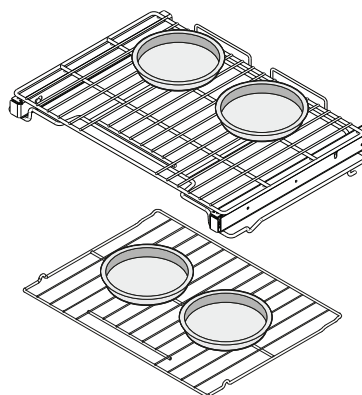

Setting Cook Time

Use Cook Time to set the amount of time needed for most oven functions. The oven will turn on immediately (or after a specified delay) and stop automatically after the set cook time ends.

In most cases you will see a cooking tip suggesting to set Cook Time after the oven is preheated.

When the programmed cook time ends:

- **Off** will appear in the display window
- an alert tone will sound
- the oven will turn off automatically

The **Off** message and an **OKAY** button will display until **OKAY** is touched.

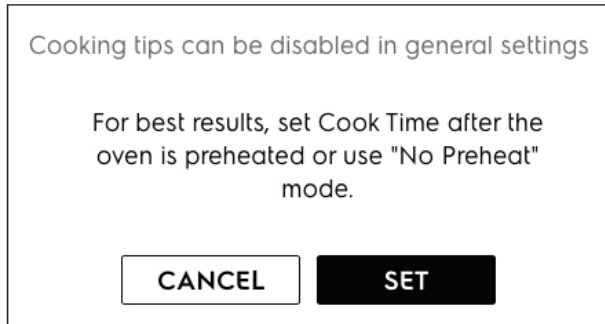

NOTE: The maximum cook time setting is 11 hours and 59 minutes unless the oven is set for continuous cooking.

To change the oven temperature or cook time after baking has started:

- Touch **+** or **-** on either side of the set temperature.
- Touch **TEMP** to access the keypad.

Setting Delay Start

Delay Start allows a delayed starting time only for Bake, Convection Bake, No Preheat, Convection Roast, Steam Clean, and Self Clean. Prior to setting a delay start, be sure the time of day is set correctly. The maximum delay for a Delay Start is one hour.

1. Press **ON/OFF** key and touch **Oven Modes**.
2. Scroll to **Delay Start** and touch:

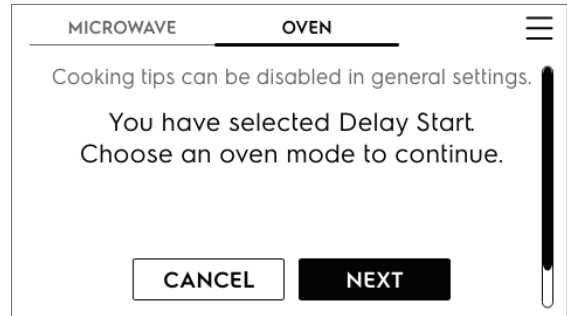

3. Follow the information on the screen to set delay time, temperature, and cook time.
4. A Delay Start time of one hour or less is allowed.

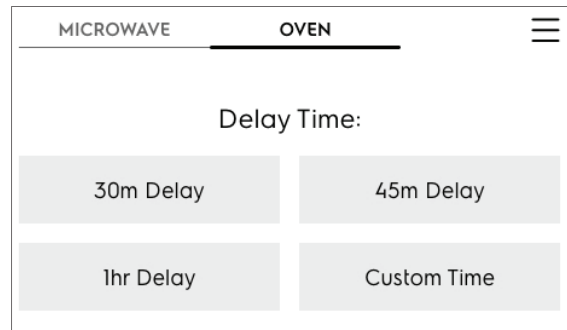

When the Delay Start time is reached, the oven will turn on and begin cooking. The screen will show the oven temperature.

When Cook Time ends, **Cooking is over** and **Off** and **OKAY** will appear in the display window, and the oven will shut off automatically.

The oven control will sound tones as a reminder until the **OKAY** is pressed.

WARNING

Food Poisoning Hazard. Do not let food sit for more than one hour before or after cooking. Doing so can result in food poisoning or sickness.

28 SETTING OVEN CONTROLS

No Preheat

No Preheat is available for single rack baking with packaged and convenience foods and can be used with regular recipes also. No Preheat may be used with temperatures between 170°F and 550°F.

Follow the recipe or package directions for food preparation time and temperature.

During No Preheat function, the oven elements will cycle on and off. The convection fan will turn on and stay on until No Preheat is canceled. Depending on your preference for doneness cooking times may vary.



CAUTION

Always use pot holders or oven mitts when using the oven. When cooking the oven interior, oven racks, and cooktop will become very hot which can cause burns.

Watch food closely.

Important:

- Always place food on rack position 3.
- Place the food with the pan or bakeware in the center of the oven rack.
- When using No Preheat, use bakeware with low or no sides. This allows the air to circulate around the food evenly.
- Leave oven light off when baking.
- Food that comes in strips, such as fish sticks and chicken tenders, should be placed on the pan with the ends pointing to the sides of the oven. Follow the package directions for food preparation time and temperature.
- Food may need to be removed early and should be checked at minimum recommended cook time.
- No Preheat works best when cooking foods longer than 10 minutes. If directions call for a shorter cooking time, a few extra minutes may be required for optimal cooking results.
- Do not open the oven door often. Opening the door will reduce the temperature in the oven and may increase cook time.
- Leave oven lights off while cooking.

To set the no preheat temperature for 350°F:

1. Arrange the interior oven racks.
2. Press **ON/OFF** key.
3. Touch **Oven Modes** and scroll to **No Preheat**.
4. Follow No Preheat tips and set temperature or use 350°F (default)
5. Touch **START**.

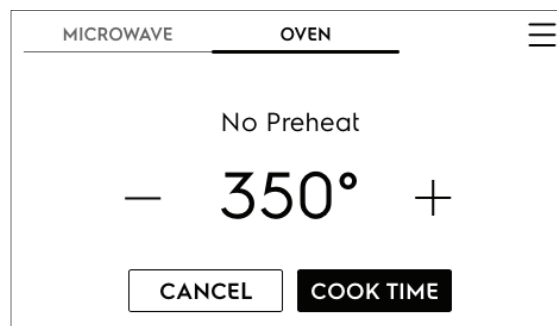

6. Set **Cook Time** if needed.
7. Touch **START**.

NOTE: If a cook time is set the oven will turn off automatically when the time expires.

8. Cooking has ended and Off will be in display.

9. Press **ON/OFF** to return display to show the time of day.

To cancel cooking anytime touch **CANCEL**.

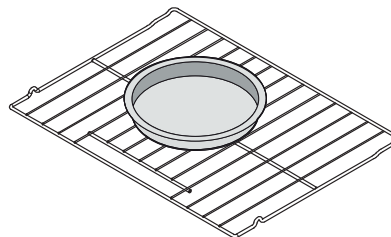
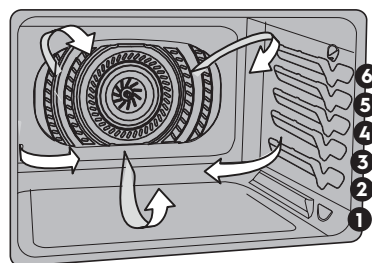

Air Fry

The Air Fry feature works best for single rack baking with packaged and convenience foods. It works well with most recipes and can be programmed for temperatures between 170°F and 550°F. Follow the recipe or package directions for food preparation quantity, time, and temperature.

Important:

- Food should be arranged in single layers on a pan and place food near the front of a single rack on position 3 for best results.
- When using Air Fry tray, place a large cookie sheet on rack position 1 to catch any crumbs or drippings.
- Leave oven light off when baking.
- Food may need to be removed early and should be checked at minimum recommended bake time. However, frozen dense foods and items with cook times less than 15 minutes may require additional time.

To set the Air Fry function:

1. Arrange food on rack as suggested.
2. Select **Air Fry** from Oven Modes.
3. Enter the suggested temperature for particular food. Touch **START**.
4. If setting a **Cook Time**, set after the oven is preheated. Cook time turns off Air Fry when time is finished. Using Cook Time is recommend for air frying high-fat foods. **NOTE:** Setting the timer for the minimum suggested time after preheat is a good option for checking food for doneness.
5. Press **START**. When preheat tone sounds place the tray on rack position 3 and to prevent smoke, place a baking sheet on rack position 1 below the Air Fry Tray.
6. When cook time ends **Off** will be in display.
7. Press **ON/OFF** to return display to show the time of day.

The Air Fry Tray is specifically designed to deliver superior performance.

Some Benefits of the Air Fry Tray:

- Tray optimized for oven space and large capacity air frying.
- Fits in the dishwasher for easy clean up.
- Higher yield than countertop models.
- Frees up countertop space.

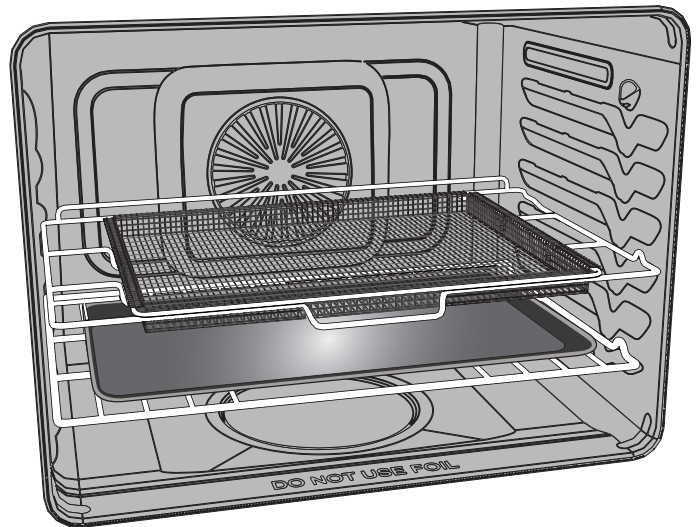
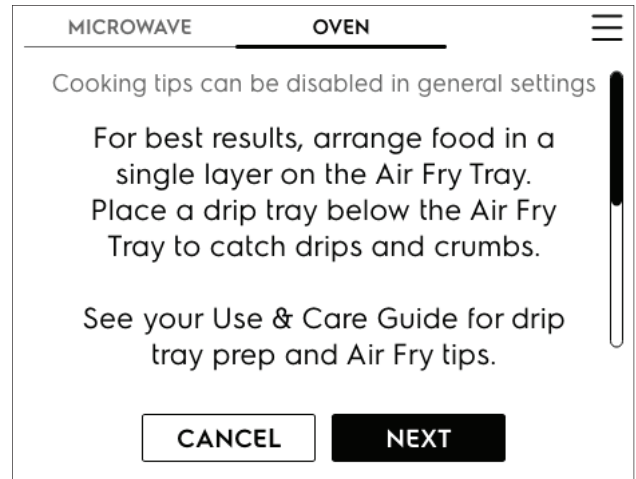

Figure 3: Air Fry Tray

Table 2: Air Fry Table

Food Type	Quantity (oz.)	Temperature	Cook Time (mins)
Frozen Tater Tots	48	450°F - 232°C	29-33
Frozen Golden Fries	48	425°F - 218°C	25-35
Frozen Chicken Nuggets	48	400°F - 205°C	13-15
Frozen Crispy Chicken Strips	48	400°F - 205°C	20-22
Frozen Hot Wings Bone-In	48	450°F - 232°C	25-28
Frozen Chicken Wings	48	375°F - 190°C	60-65
Fresh Chicken Wings	48	450°F - 232°C	30-40

30 SETTING OVEN CONTROLS

Convection Bake

Convection Bake uses a fan to circulate the oven's heat uniformly around the oven. This improved heat distribution allows for even cooking and browning results. Heated air flows around the food from all sides.

Convection bake may be set for any oven temperature between 170°F (77°C) and 550°F (288°C).

Benefits of convection cooking include:

- Multiple rack baking.

Convection baking tips:

- Use Convection Bake for best results when baking cookies and cakes on 2 racks.
- For best results it is recommended to preheat the oven before baking items like cookies, biscuits and breads and move pans to the center of the racks.
- If your recipe is not written for convection baking, reduce the oven temperature by 25° or use Convection Convert option.
- No special pans or bakeware required.
- For cookies use the following racks:
 - Single rack baking use 3 (flat rack).
 - Two rack baking use 2 (flat) and 4 (glide).
- For baking cakes use the following rack positions and place bakeware as shown in Figure 4. In upper rack use position 4 (glide) or 5 (flat).
- Cookies and biscuits should be baked on pans with no sides or very low side to allow heated air to circulate around the food. Food items baked on pans with a dark finish will cook faster.
- Leave oven lights off while baking.

Convection Convert

Convection Convert automatically reduces the oven temperature from what is specified in most baking recipes to compensate for the increased cooking efficiency of convection baking.

To set convection bake with a default oven set temperature of 325°F (163°C):

1. Select **Oven Mode** and scroll to **Convection Bake**
2. Touch **Convection Bake**: Default oven temp of 325° appears.
3. An option for **Convection Convert** is visible on the screen. Using it will lower the oven temperature 25° to account for the increased efficiency of convection. If used, Convection Convert must be selected before pressing Start
4. Touch **START**:
5. Option to set **Cook Time**.
6. Touch **START**.
7. Oven will turn off when **Cook Time** is complete.
8. Cooking has ended and **Off** will be in display.
9. Press **ON/OFF** to return display to show the time of day.

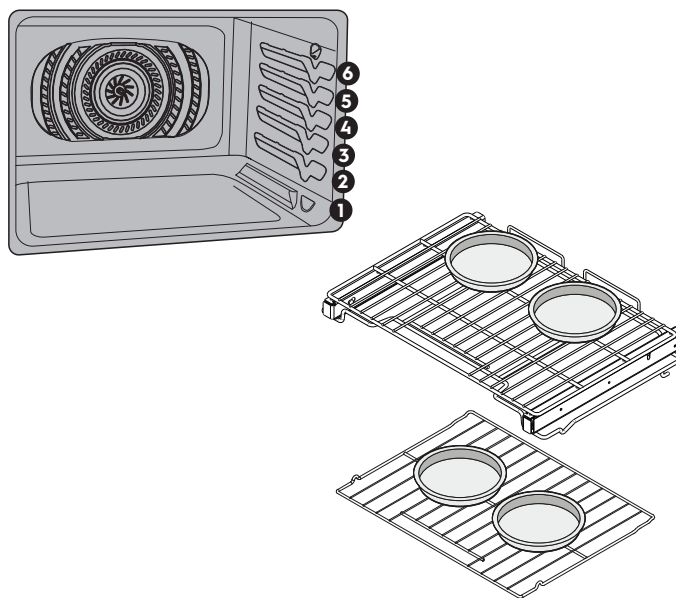
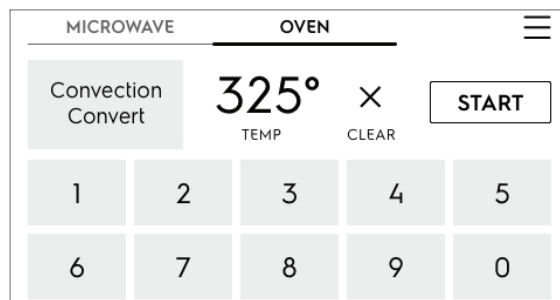

Figure 4: Pan positions for best results when baking cakes on two racks.

Air Sous Vide

Air Sous Vide is ideal for cooking meats to achieve tenderness without overcooking.

How Sous Vide Works

Sous vide is a French phrase meaning “under vacuum”. In sous vide cooking, food is vacuum-sealed in plastic pouches, which are then placed in a cooking medium of hot water or air.

Your appliance uses hot air circulating around sealed pouches to cook food slowly at relatively low temperatures: 100°F to 205°F (38°C to 94°C). Sous vide cooking is not fast, but with a little planning, it can be very easy.

Advantages of Sous Vide

- Food does not lose flavor or aroma due to evaporation.
- Vitamins and minerals do not escape during cooking.
- The low cooking temperature leaves meat and fish more tender.
- Less spice is needed, as food keeps more of its natural flavor.
- The low cooking temperature greatly reduces the risk of overcooking. The food never gets hotter than the intended serving temperature.
- Timing is less critical. If different dishes are finishing at different times, food that has reached serving temperature can wait, since it stays at serving temperature in the cooking medium.

Food Safety

Because sous vide cooks at relatively low temperatures, safe food handling is especially important:

- Always keep raw food in safe conditions before you start cooking.
- Clean the raw food before you start cooking.
- Use Table 1, “Recommended Sous Vide Cook Settings,” to find the recommended cooking time and temperature for the food.
- Only use temperatures below 140°F (60°C) to cook foods that can be safely eaten raw.
- Food should be between 34°F and 37°F (normal refrigerator temperatures) when preparing to place food in sous vide vacuum pouch.
- Sous vide dishes are best served immediately after cooking. If food is not served immediately, use an ice bath to chill it quickly and then keep it refrigerated for up to 3 days.
- Do not use sous vide to reheat leftovers.
- Do not allow raw food to contact cooked food during preparation. Do not use the same tools on different food items without washing them.
- If the recipe includes raw eggs, keep the whites and yolks from touching the outsides of the shells.
- Blanching in boiling water or searing in a pan before sous vide cooking can destroy surface bacteria to improve food safety.
- Do not use Delay Start with the Sous Vide function.
- Do not use a meat probe with the Sous Vide function. Food needs to be sealed air-tight in a pouch for sous vide cooking.

32 SETTING OVEN CONTROLS

Vacuum Sealing

Sous vide cooking in your oven requires a vacuum sealer and vacuum pouches. The pouch needs to be sealed so no air or liquid can leak out. A pouch that leaks will produce poor cooking results and may produce smoke and residue that can burn during future cooking or when using self-clean. Follow the instructions that come with your sealer and pouches.

- Use pouches that are specified for your sealer and for sous vide cooking.
- Do not reuse vacuum pouches.
- Put food in one layer in the pouch for even cooking.
- It is recommended to use one food portion per vacuum pouch.
- For most sous vide cooking, use the highest vacuum setting for best cooking results.
- Make sure that the closure of the pouch is clean to get a good seal. If cooking at higher temperatures (above 160° F / 71° C), double-seal the pouch.
- Vacuum pouches are solely for sous vide cooking and should not be used for regular baking or broiling.

Sous Vide Cooking

1. Prepare
 - Start with the freshest, highest quality food possible.
 - Clean and cut the ingredients.
2. Package
 - Place the ingredients in the plastic pouch for your vacuum sealer. Add seasonings for cooking.
 - Note: If cooking multiple items at once, you may want to write the contents on the outside of the pouches before filling and sealing them.
 - Vacuum seal the pouch, removing as much air as possible. Verify that you have achieved an air-tight seal.
 - If not cooking immediately, store the pouch in a refrigerator until ready to cook.

To cook Air Sous Vide:

1. Touch **Oven Modes** and scroll to **Air Sous Vide**.
2. Touch **Air Sous Vide**: display shows 130°F (54°C) setting as default.

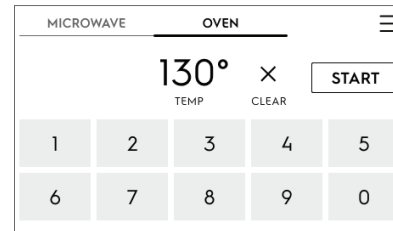

3. Set desired temperature.
4. Touch **START**.

IMPORTANT: Since sous vide cooking allows for a suggested minimum cooking time and a target time, it is recommended to set the timer to at least the minimum time or to any time up to the target suggested time. With sous vide cooking there is a maximum cooking time which allows the user more flexibility when cooking with no specific end time.

Note: Use the sous vide feature of your oven to cook the food (section reference). Use the settings recommended for the type of food in Table 1, "Recommended Sous Vide Cook Settings,".

5. Finish
 - Open the plastic pouch and remove the food.
 - You may finish the food with a final searing or grilling to achieve a nice crust and roast flavor.
 - Add final seasonings or sauces if needed.
 - Serve.

CAUTION

Even though sous vide cooks at relatively low temperatures, use care when handling the pouch and its contents, which will be hot to the touch.

Only use temperatures below 140°F (60°C) for cooking foods that can be safely eaten raw.

IMPORTANT

The U.S. Department of Agriculture states, "Rare fresh beef is popular, but you should know that cooking it to only 140°F (60°C) means some food poisoning organisms may survive." (Source: Safe Food Book, Your Kitchen Guide, USDA) The lowest temperature recommended by the USDA is 145°F (63°C) for medium rare fresh beef. For beef medium 160°F, well done 170°F (77°C). Visit the USDA Food Safety and Inspection website at www.fsis.usda.gov.

Table 3: Sous Vide Table

Food	Doneness	Temperature	Cooking Time		
			Minimum	Target	Maximum
Beef					
Steak	Rare	130° F / 54°-55° C	2 hours	3 hours	4 hours
Steak	Medium Rare	135° F / 57°-58° C	2 hours	3 hours	4 hours
Steak	Medium	145° F / 62°-63° C	2 hours	3 hours	4 hours
Steak	Medium Well	150° F / 65°-66° C	2 hours	3 hours	4 hours
Steak	Well	160° F / 71°-72° C	2 hours	3 hours	4 hours
Roast	Rare	135° F / 57°-58° C	6 hours	7 hours	16 hours
Roast	Medium Rare	140° F / 60° C	6 hours	7 hours	16 hours
Roast	Medium	150° F / 65°-66° C	6 hours	7 hours	16 hours
Roast	Medium Well	155° F / 68°-69° C	6 hours	7 hours	16 hours
Roast	Well	160° F / 71°-72° C	6 hours	7 hours	16 hours
Chuck/Brisket	Rare	140° F / 60° C	20 hours	24 hours	48 hours
Chuck/Brisket	Medium Rare	150° F / 65°-66° C	20 hours	24 hours	48 hours
Chuck/Brisket	Well	180° F / 82°-83° C	20 hours	24 hours	48 hours
Pork					
Chop	Medium	150° F / 65°-66° C	2 hours	3 hours	4 hours
Chop	Well	160° F / 71°-72° C	2 hours	3 hours	4 hours
Roast	Medium	150° F / 65°-66° C	2 hours	3 hours	4 hours
Roast	Well	180° F / 82°-83° C	2 hours	3 hours	4 hours
Shoulder/Belly	Medium	150° F / 65°-66° C	10 hours	24 hours	48 hours
Shoulder/Belly	Well	180° F / 82°-83° C	10 hours	24 hours	48 hours
Chicken					
Parts	Tender	170° F / 76°-77° C	2 hours	2-1/2 hours	4 hours
Fish					
Steak	Tender	105° F / 40°-41° C	1 hour	1-1/2 hours	2 hours
Steak	Flaky	125° F / 51°-52° C	1 hour	1-1/2 hours	2 hours
Steak	Well	145° F / 62°-63° C	1 hour	2 hours	2 hours
Fillet	Tender	105° F / 40°-41° C	45 mins	1 hour	1 1/2 hours
Fillet	Flaky	125° F / 51°-52° C	45 mins	1 hour	1 1/2 hours
Fillet	Well	145° F / 62°-63° C	45 mins	1 hour	1 1/2 hours
Vegetables					
Squash	Cubes	180° F / 82°-83° C	1 hour	1 1/2 hours	4 hours
Roots	Sliced/Cubes	180° F / 82°-83° C	1 hour	1 1/2 hours	4 hours
Potatoes	Sliced/Cubes	200° F / 93°-94° C	1 hour	1 1/2 hours	4 hours
Fruits					
Warm/Ripe	Sliced/Cubes	155° F / 68°-69° C	45mins	105 mins	2 1/2 hours
Soft	Purees	180° F / 82°-83° C	15 mins	30 mins	90 minutes
Steak thickness based on 1.5". Thicker cuts may require longer times.					

34 SETTING OVEN CONTROLS

Setting Broil

Use the broil function to cook foods that require direct exposure to radiant heat for optimum browning results. Broiling may produce smoke. If smoke is excessive, place food further away from the heating element.

The broil feature preset to 550°F. Broil may be set at any temperature between 400°F (205°C) and 550°F (288°C).

WARNING

Should an oven fire occur, close the oven door and turn the oven off. If the fire continues, use a fire extinguisher. Do not put water or flour on the fire. Flour may be explosive and water can cause a grease fire to spread and cause personal injury.

CAUTION

Always use pot holders or oven mitts when using the oven. When cooking, the oven interior, oven racks, and cooktop will become very hot which can cause burns.

IMPORTANT

Broiler pans and inserts allow the grease to drain away from the high heat of the broiler. Do not use the pan without the insert. Do not cover the insert with foil - the exposed grease could ignite.

To set broil with the default broil oven temperature of 550°F (288°C):

1. Arrange the oven racks when cool. For optimum browning results, preheat oven for 2 minutes before adding food.
2. Select **Oven Mode** and scroll to **Broil**.
3. Default **550°** appears.
4. If lower broil temperature is needed use keypad to select between 400° and 550°.

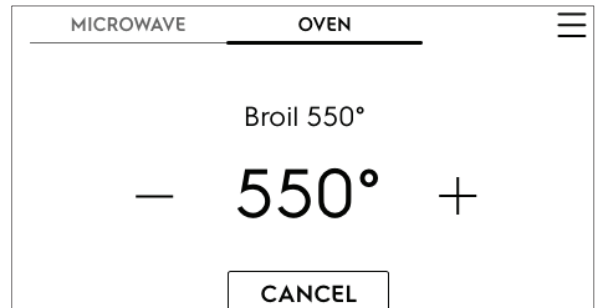

5. Press **START**. Broil with oven door closed.
6. Broil on one side until food is browned; turn and broil other side until done to your satisfaction.
7. When finished broiling, press **ON/OFF**.

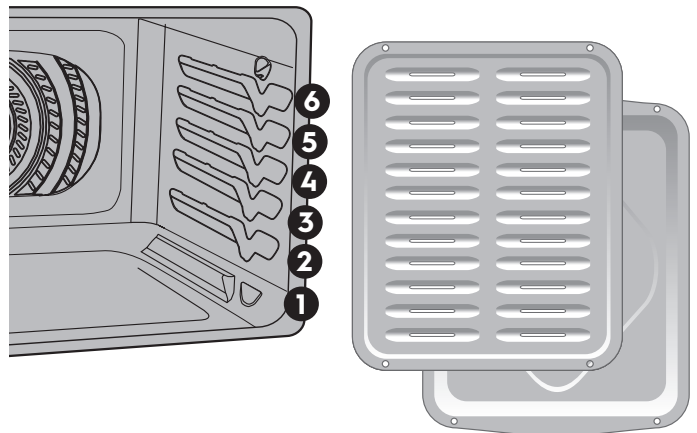

Important notes:

- Always arrange oven racks when the oven is cool.
- For best results when broiling, use a broil pan with broil pan insert designed to drain the fat from the food and help avoid spatter and reduce smoking.
- When broiling, always pull the oven rack out to the stop position before turning or removing food.

Table 4: Broil recommendations

Food item	Rack Position	Temp	Cook time in minutes		Internal Temperature	Doneness
			1st side	2nd side		
Steak 1" thick	6	550°F (288°C)	5:00	4:00	140°F (60°C)	Rare**
Steak 1" thick	6	550°F (288°C)	6:00	4:00	145°F (63°C)	Medium
Steak 1" thick	6	550°F (288°C)	7:00	5:00	160°F (71°C)	Medium-well
Steak 1" thick	6	550°F (288°C)	8:00	6:00	170°F (77°C)	Well
Pork Chops 3/4 "thick	6	550°F (288°C)	12:00	10:00	170°F (77°C)	Well
Chicken - Bone In	6	450°F (232°C)	20:00	10:00	170°F (77°C)	Well
Chicken Boneless	6	450°F (232°C)	8:00	6:00	170°F (77°C)	Well
Fish	6	550°F (288°C)	as directed		170°F (77°C)	Well
Shrimp	6	550°F (288°C)	as directed		170°F (77°C)	Well
Hamburger 1" thick	6	550°F (288°C)	9:00	7:00	145°F (63°C)	Medium
Hamburger 1" thick	6	550°F (288°C)	10:00	8:00	170°F (77°C)	Well

The U.S. Department of Agriculture states, "**Rare fresh beef is popular, but you should know that cooking it to only 140°F (60°C) means some food poisoning organisms may survive." (Source: Safe Food Book, Your Kitchen Guide, USDA Rev. June 1985.) The lowest temperature recommended by the USDA is 145°F (63°C) for medium rare fresh beef. For well done 170°F (77°C). All cook times shown are after 2 minutes of preheating.

36 SETTING OVEN CONTROLS

Convection Roast

Convection roast combines a cook cycle with the convection fan and elements to rapidly roast meats and poultry. Heated air circulates around the meat from all sides, sealing in juices and flavors. Meats cooked with this feature are crispy and brown on the outside while staying moist inside.

WARNING

Should an oven fire occur, close the oven door and turn the oven off. If the fire continues, use a fire extinguisher. Do not put water or flour on the fire. Flour may be explosive and water can cause a grease fire to spread and cause personal injury.

CAUTION

Always use pot holders or oven mitts when using the oven. When cooking, the oven interior, oven racks, and cooktop will become very hot which can cause burns.

To use convection roast at a temperature of 350°F (177°C):

1. Touch **Oven Mode** and scroll to **Convection Roast**.
2. Touch **Convection Roast**.
3. **Set** desired temperature or use default of **350°**.
4. Touch **START**.
5. Option to set **Cook Time**.
6. Touch **START**. Preheating the oven is not necessary.
7. When cooking is completed or to cancel Convection Roast press **ON/OFF**.

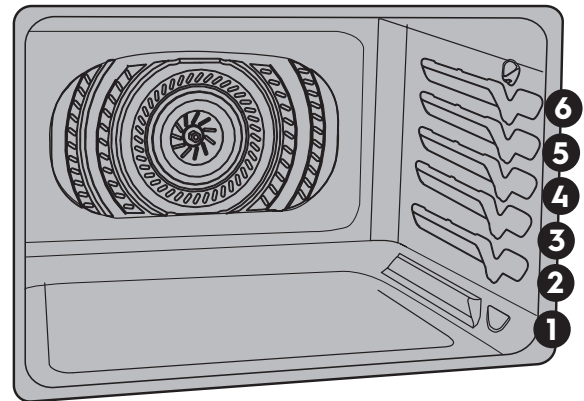

Figure 5: Convection roasting on lower oven racks

Convection Roasting tips:

- Preheating for convection roast is not necessary for most meats and poultry.
- Arrange oven racks so meat and poultry are on the lowest rack of the oven.
- Since convection roast cooks faster, may be able to reduce cook times as much as 25% from the recommended time of your recipe (check the food at this time). Then if needed, increase cook time until the desired doneness is obtained.
- Do not cover foods when dry roasting - covering will prevent the meat from browning properly.
- When cooking meats use the broiler pan and insert. The broiler pan will catch grease spills and the insert helps prevent grease splatters.

Table 5: Convection Roasting recommendations

Meat		Weight	Oven Temp	Internal Temp	Mins per lb
Beef	Standing rib roast*	4 to 6 lb.	350°F (177°C)	*160°F (71°C)	25-30
	Rib eye roast*	4 to 6 lb.	350°F (177°C)	*160°F (71°C)	25-30
	Tenderloin roast	2 to 3 lb.	400°F (204°C)	*160°F (71°C)	15-25
Poultry	Turkey whole**	12 to 16 lb.	325°F (163°C)	180°F (82°C)	8-10
	Turkey whole**	16 to 20 lb	325°F (163°C)	180°F (82°C)	10-15
	Turkey whole**	20 to 24 lb.	325°F (163°C)	180°F (82°C)	12-16
	Chicken	3 to 4 lb.	350°F-375°F (177°C-191°C)*	180°F (82°C)	12-16
Pork	Ham roast, fresh	4 to 6 lb.	325°F (163°C)	160°F (71°C)	30-40
	Shoulder blade roast	4 to 6 lb.	325°F (163°C)	160°F (71°C)	20-30
	Loin	3 to 4 lb.	325°F (163°C)	160°F (71°C)	20-25
	Pre-cooked ham	5 to 7 lb.	325°F (163°C)	160°F (71°C)	30-40

* The U.S. Department of Agriculture states, "Rare fresh beef is popular, but you should know that cooking it to only 140°F (60°C) means some food poisoning organisms may survive." (Source: Safe Food Book, Your Kitchen Guide) The lowest temperature recommended by the USDA is 145°F (63°C) for medium rare fresh beef. For well done 170°F (77°C)** Stuffed turkey requires additional roasting time. Shield legs and breast with foil to prevent over browning and drying of the skin.

38 SETTING OVEN CONTROLS

Cooking with Food Probe

Use the probe feature for best results when cooking foods such as roasts, hams, or poultry.

The Food Probe works with the following oven modes: Bake, Convection Bake, Air Fry, Convection Roast, Steam Roast, and Turkey.

The probe feature, when set correctly, will signal an alert when the internal food temperature reaches the desired set target temperature. The probe settings for how the oven behaves should be set first in the oven menu.

When active, the probe displays the internal food temperature which is visible in the display during the cooking process. This eliminates any guesswork or the need to open the oven door to check the thermometer.

For meats like poultry and roasts, using a probe to check internal temperature is the safest method to ensure properly cooked food.

To set Food Probe: Touch **Oven Modes**, scroll to **Food Probe** and follow directions on the display.

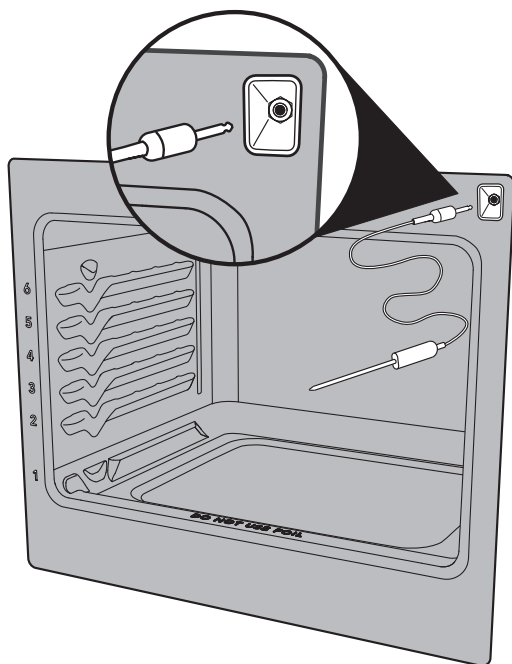

! CAUTION

Do not use kitchen utensils to pull on the probe cable or handles. Always insert and remove the probe using the provided handles, as shown in and always use a pot holder to protect hands from possible burns.

Proper placement of probe in food.

Insert the probe so that the probe tip rests inside the center of the thickest part of meat or food. For best results, do not allow the probe temperature sensor to contact bone, fat, gristle, or the cookware.

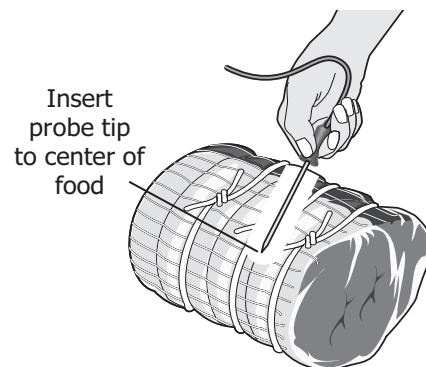

- For bone-in ham or lamb, insert the probe into the center of lowest large muscle or joint.
- For meat loaf or casseroles, insert the probe into center of food.
- When cooking fish, insert meat probe just above the gill.
- For whole poultry or turkey, fully insert the probe sensor into the thickest part of the breast.

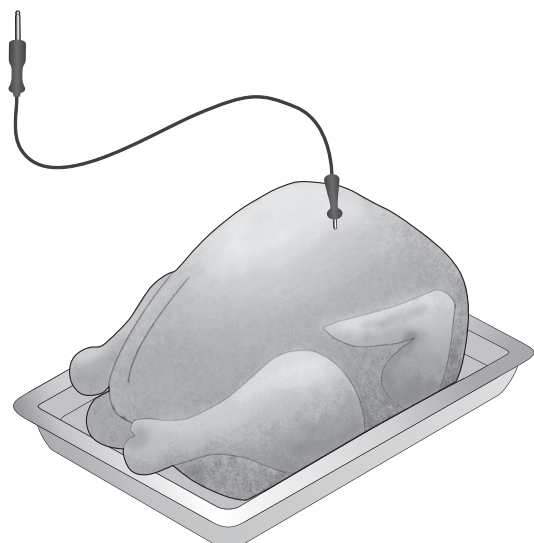

Using the Food Probe for Turkey

1. Select **Oven Modes** and scroll to **Food Probe**.
2. The display will remind you to insert the probe into the turkey and place in oven on rack position 1.
3. Display reminds you to connect the food probe to the receptacle before setting oven mode:
4. Touch **NEXT**.
5. Touch **Turkey** in Oven Modes.
6. Set target food temperature after pressing **NEXT**.
7. Set oven temperature and press **START**.
8. When the target temperature of the turkey (internal temperature) is reached, the oven will turn off if set for cooking to stop in the Oven Menu settings.

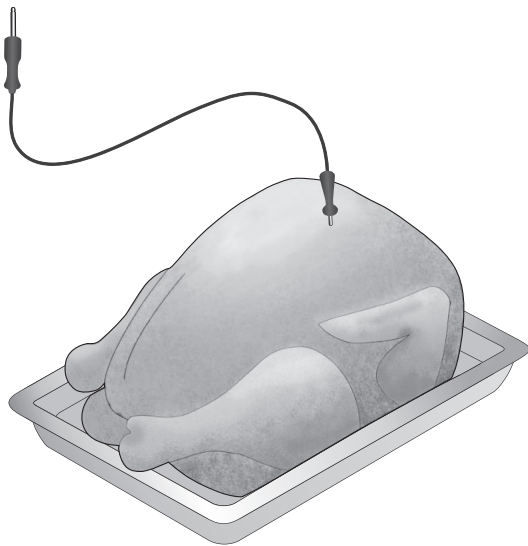

Keep Warm

➔ NOTE

During cooking, the internal food temperature will display in the center of the screen. The oven temperature will be displayed at the bottom of the screen beside the cancel key. To assure accuracy, do not remove the probe from the food or receptacle until the desired internal temperature is reached.

If the probe is removed from the receptacle only, the probe feature will cancel and the oven will turn off. If the probe is removed from the food only, the probe feature will remain active and may eventually generate a probe too hot message.

To change the target (internal food) temperature or the set oven temperature touch the one you want to change and use the **+** or **-** to adjust the temperature.

Table 6: USDA recommended minimum internal cooking temperatures

Food Type	Internal Temp.
Ground meat and meat mixtures	
Beef, Pork, Veal, Lamb	160°F (71°C)
Turkey, Chicken	165°F (74°C)
Fresh beef, veal, lamb	
Medium rare +	145°F (63°C)
Medium	160°F (71°C)
Well Done	170°F (77°C)
Chicken and Turkey, whole	165°F (74°C)
Poultry Breasts, Roasts	165°F (74°C)
Poultry Thighs, Wings	165°F (74°C)
Stuffing (cooked alone or in bird)	165°F (74°C)
Ham Fresh (raw)	160°F (71°C)
Ham Pre-cooked (to reheat)	140°F (60°C)
Eggs dishes	160°F (71°C)
Leftovers and Casseroles	165°F (74°C)

The U.S. Department of Agriculture states, "Rare fresh beef is popular, but you should know that cooking it to only 140°F (60°C) means some food poisoning organisms may survive." (Source: Safe Food Book, Your Kitchen Guide, USDA) Visit the USDA Food Safety and Inspection website at www.fsis.usda.gov

➔ IMPORTANT

Do not store the probe inside the oven. Use only the original probe provided. Connecting any other probe or device could result in damage to the oven control, electronics, and the receptacle.

Before starting self clean, double check that the probe is removed from the oven interior. Defrost frozen foods completely before inserting the probe.

40 SETTING OVEN CONTROLS

Multi-Racks

Multi-Rack is for baking on up to two racks while following recommended time and temperature. The oven will make adjustments for best results.

IMPORTANT: Be sure to use suggested rack positions before setting oven.

- Follow recipe for time and temp and the oven will make needed adjustments for best performance.
- Fully preheat the oven for best results.
- Pans and pizzas should be placed in the center of the rack.
- Allow at least 2 inches (5 cm) of space between bakeware for proper air circulation.
- Leave oven lights off while baking.
- Use flat rack in position 2 and glide rack in position 4.

To use Multi-Rack:

1. Arrange the oven racks when cool.
2. Select **Oven Mode** and scroll to **Multi Racks**.
3. Touch **Multi Racks**.
4. Default **350°** appears. Set another temperature if desired.
5. Touch **START**.
6. Set **Cook Time** if needed.
7. Press **START**.
8. When Cook Time ends the oven turns off automatically.
9. Cooking has ended and Off will be in display.
10. Press **ON/OFF** to return display to show the time of day.

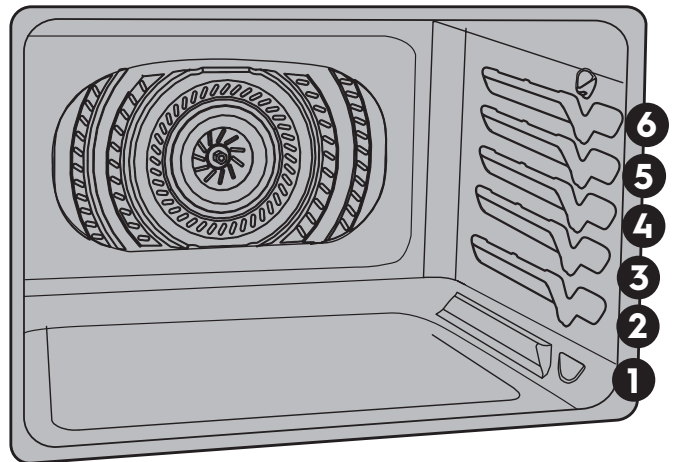

Cooking with Steam

Note: More moisture will be present than during conventional baking or roasting. Moisture could condense on handle or in the door, and depending on the conditions in your kitchen possible drip onto the floor.

Steam Cooking Tips:

Oven Positioning

- Use flat rack in the lowest position in the oven for most foods for Steam Roast.
- Lowest position for poultry.

Preparing

- Use 2-½ cups of water for steam bake and steam roast. If steam functions are frequently used, use distilled water.
- Using water container, pour water slowly onto the bottom of oven cavity while still cool.
- Never add water if the oven is warm.
- Never add water during a Steam Bake or Steam Roast cycle.

While in Use

- When using Steam, follow recipe for preheating, cook time and cook temperature.
- Always start with a cold oven.
- Preheating is not necessary when using steam roast.

Cleaning

- With a paper towel lightly soaked in distilled white vinegar, wipe out bottom of oven cavity after the oven is cooled or before each use.
- Use the self clean function to clean heavily soiled areas.
- If residue remains after self clean, pour a thin layer of distilled white vinegar onto the bottom of the oven cavity. Allow to sit for 30 minutes. Wipe out vinegar.

Steam Bake

Steam creates the best conditions for baking bread on a single rack. Baked goods will have improved browning and texture and is recommended for baking moist and flavorful breads and pastries such as baguettes and croissants.

Use flat rack in position 2 for best results for Steam Bake. pans should be placed in the center of the rack.

To set Steam Bake:

1. Select **Oven Modes** and scroll to **Steam Bake**.
2. Follow the instructions on the screen and add three cups of water to oven bottom as directed.

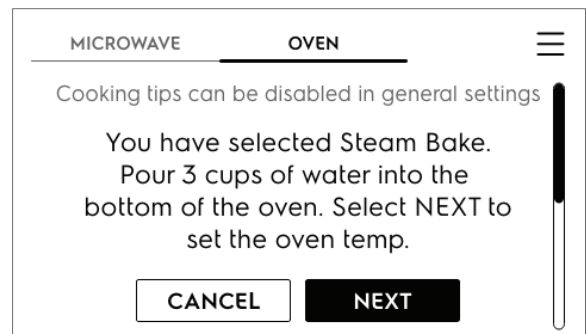

3. Touch **NEXT** and follow Steam Bake instruction for setting temperature.
4. Touch **START**.
5. Set **Cook Time**. (Suggests waiting to set Cook Time until oven preheats.)
6. When **Cook Time** ends oven turns off automatically.
7. **Cooking has ended** and **Off** will be in display.
8. Press **ON/OFF** to return to show the time of day.

Important: Stand to the side of the oven when opening to allow any steam to escape.

42 SETTING OVEN CONTROLS

Steam Roast

Steam creates the best conditions for roasting proteins. Meats will be crisp outside and juicy inside.

Steam Roast is recommended for meat or poultry.

To set Steam Roast:

1. Select **Oven Modes** and scroll to **Steam Roast**.
2. Follow the instructions on the screen and add three cups of water to the bottom of the oven as directed.
3. Touch **NEXT** and follow Steam Roast instruction for setting temperature.
4. Touch **START**.
5. When **Cook Time** ends oven turns off automatically.
6. **Cooking has ended** and **Off** will be in display.
7. Press **ON/OFF** to return display to show the time of day.

➔ IMPORTANT

Stand to the side of the oven when opening to allow any steam to escape.

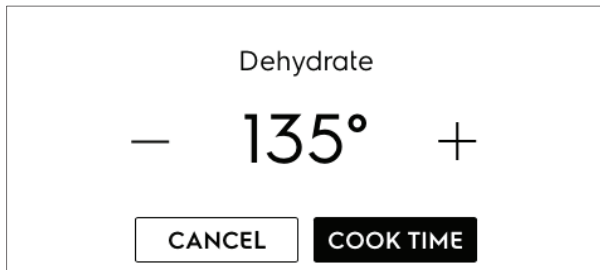
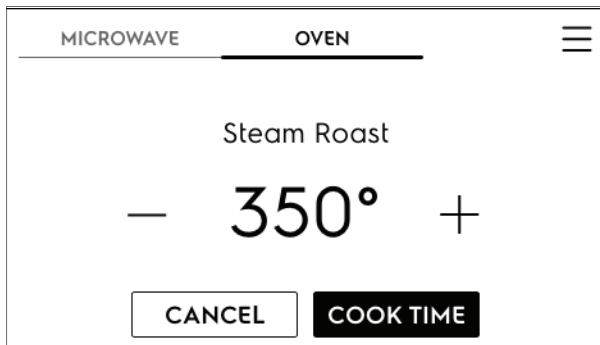

Bread Proof

Bread proofing creates the best conditions for yeast to multiply and cause your dough to rise.

1. Select **Oven Mode** and scroll to **Bread Proof**.
2. Touch **Bread Proof**: Shows **Bread Proof 100°F** (38°C).
3. Touch **START**. Cook Time Option is offered. If Cook Time is set touch **START**.
4. When Cook Time ends Bread Proof turns off automatically.

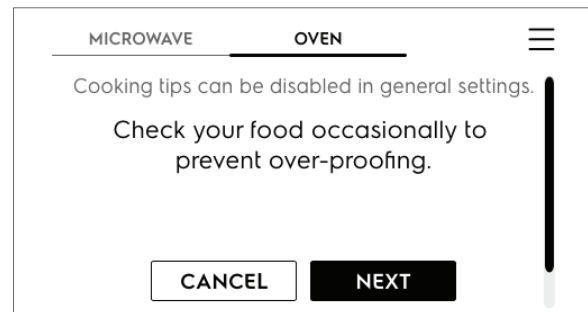

➔ NOTE

Check often to prevent over-proofing.

Dehydrate

For best results when dehydrating food use the Air Fry tray which allows air to circulate all around the food for faster preservation.

To set Dehydrate:

1. Arrange food in a single layer on the Air Fry tray.
2. Select **Oven Modes** and scroll to **Dehydrate**.
3. Set dehydrate temperature (between 95°F -170°F).
4. Touch **START**.
5. Set **Cook Time** if desired.
6. When **Cook Time** ends the oven turns off automatically.
7. **Cooking has ended** and **Off** will be in display.
8. Press **ON/OFF** to return display to show the time of day.

➔ NOTE

Check food for doneness. If any moisture is present, allow food to dehydrate longer.

Keep Warm

Keep Warm should only be used with foods that are already at serving temperatures. Keep warm will keep cooked foods warm and ready for serving after cooking has finished.

Keep warm will keep the oven temperature at 140° F - 200° F (60°C - 93°C).

To set Keep Warm:

1. If needed, arrange oven racks and place cooked food in oven.
2. Press **Oven Modes** and scroll to **Keep Warm**:
3. Touch **Keep Warm**.
4. Set desired temperature.
5. Press **START**.
6. **Keep Warm** will stay on until canceled.

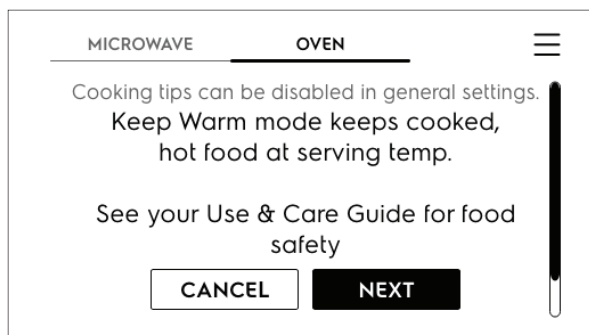

Setting the Sabbath Feature for the Jewish Sabbath and Holidays (some models)

For further assistance, guidelines for proper usage, and a complete list of models with the Sabbath feature, please visit the web at www.star-k.org.



This appliance provides special settings for use when observing the Jewish Sabbath/Holidays. Sabbath mode disables all audible tones or visual display changes on the oven control. Bake is the only cooking feature available while in the Sabbath mode. Most oven controls are locked during Sabbath mode.

To start Sabbath Mode, first select Sabbath from the settings menu. Next, select Delay (if desired), Bake temperature, and cook time (if desired) and set. Cooking will begin after any specified delay.

If cook time was set, once the time has elapsed, the cooking will end and the display will show Idle to indicate that the cook time has ended.

Important: The Sabbath mode will override the factory preset 12 hour energy saving mode, and the appliance will stay on until the cooking features are canceled. If cooking is canceled when the appliance is in the Sabbath mode, no audible or visual indicators will be available to verify the cancellation.

If the oven interior lights are needed, be sure to activate them prior to setting the Sabbath mode. Once the oven light is turned on and the Sabbath mode is active, the oven light will remain on until the Sabbath mode is turned off and the oven lights are turned off. The oven door will not activate the interior oven lights when the oven door is opened or closed.

It is recommended that any oven temperature modification made within an active Sabbath mode press the + or - key.

The temperature will increase or decrease with each press by 5°F or 1°C and the change will be accepted automatically.

44 SETTING OVEN CONTROLS

WARNING

Food poisoning hazard. Do not let food sit for more than one hour before or after cooking. Doing so can result in food poisoning or sickness. Foods that can easily spoil such as milk, eggs, fish, meat or poultry, should be chilled in the refrigerator first. Even when chilled, they should not stand in the oven for more than 1 hour before cooking begins, and should be removed promptly when finished cooking.

Important:

- Do not attempt to activate any other oven function except Bake while the Sabbath feature is active. When the Sabbath feature is active, only the + and - keys and OFF will function. ALL OTHER KEYS should not be used once the Sabbath feature is active.
- You may change the oven temperature once baking has started. Use the + and - keys to raise or lower the oven temperature. Each press of an arrow key will raise or lower the temperature by 5°F (1°C).
- Remember that the oven control will no longer provide audible tones or display any further changes when the Sabbath feature is active.
- The oven will shut-off automatically after completing a bake time and therefore may only be used once during the Sabbath/Jewish Holidays.

SETTING SABBATH MODE:

Sabbath Mode is set using the **Menu Options**.

1. Touch the **Menu Options** bars.
2. Scroll to **Sabbath Mode**.
3. Touch **Sabbath Mode** and follow all instructions on screen.

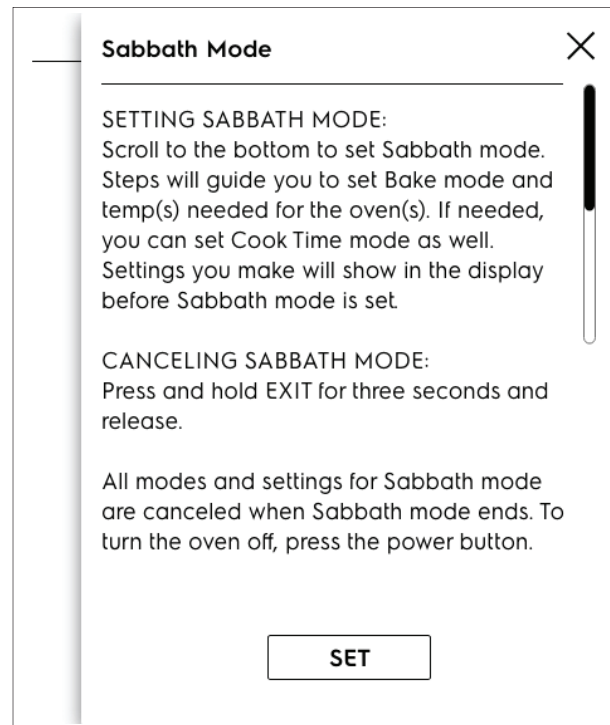

To exit Sabbath Mode, press and hold **EXIT** for three seconds.

Self Clean

A self cleaning oven cleans itself with high temperatures (well above normal cooking temperatures), which vaporizes soils or reduces them to a fine powdered ash you can wipe away afterwards with a damp cloth. This function can be programmed for clean times between 2 and 4 hours.

Important: Before starting self clean read all following caution and important statements before starting a self clean cycle.

CAUTION

- Do not leave small children unattended near appliance. During self clean cycle, the outside of the oven can become very hot and cause burns if touched.
- Do not line the oven walls, racks, oven bottom, or any part of the range with aluminum foil. This will cause permanent damage to the oven interior and destroy heat distribution, and will melt to the oven interior.
- Do not force the oven door open. This will damage the automatic door locking system. Use caution when opening the oven door after the self clean cycle ends. The oven may still be very hot and cause burns. To avoid possible burns, stand to side of oven when opening door to allow steam or hot air to escape.
- The health of some birds is extremely sensitive to fumes given off during the self clean cycle of any range. Move birds to a well ventilated room.

Important notes:

- Completely remove all oven racks and any accessories from oven cavity to avoid damage to oven racks. If the oven racks are not removed they may discolor.
- Remove all items from the oven and cooktop including cookware, utensils, and any aluminum foil. Aluminum foil will not withstand high temperatures from a self clean cycle and will melt.
- Do not spray oven cleaners or oven protective coatings in or around any part of the oven interior. Clean any soil from the oven frame, the door liner outside the oven door gasket, and the small area at the front center of the oven bottom (page 45). These areas heat sufficiently to burn soil on. Clean using soap and water prior to starting Self

Clean.

- Remove any excessive spills. Any spills on the oven bottom should be wiped up and removed before starting a self clean cycle. To clean use hot, soapy water and a cloth. Large spills can cause heavy smoke or fire when subjected to high temperatures.
- Do not allow food spills with high sugar or acid content (such as milk, tomatoes, sauerkraut, fruit juices, or pie fillings) to remain on the surface as they may leave a dull spot even after cleaning.
- Do not clean the oven door gasket. The woven material in the gasket is essential for a good seal. Care should be taken not to rub, damage, or remove the oven door gasket. Doing so could cause damage to the door gasket and compromise the performance of the oven.
- The kitchen area should be well ventilated using an open window, ventilation fan, or exhaust hood during the first self clean cycle. This will help eliminate the normal odors.

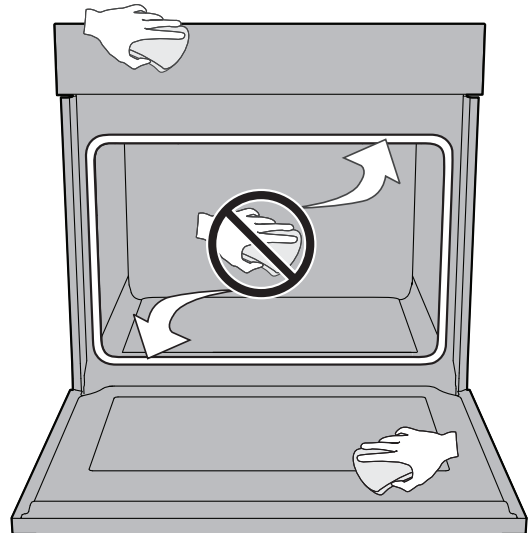

Figure 6: Clean around the oven door gasket

- Do not attempt to open the oven door when the OVEN LOCK indicator light is flashing. Allow about 15 seconds for the motorized door latch mechanism to completely lock or unlock the oven door.
- When the clean time finishes, the oven door will remain locked until the range has cooled sufficiently. In addition to the clean time that was programmed, you must allow about 1 additional hour for the oven to cool before you will be able to open the oven door.

46 SETTING OVEN CONTROLS

To set a self clean cycle:

1. Be sure the oven is empty and all oven racks are removed. Remove all items from the oven. Be sure oven door is completely closed.
2. Touch **Oven Modes** and scroll to **Self Clean**.
3. Touch **Self Clean** and select 2 hour, 3 hour, or 4 hour clean time.
4. Press **TIMER** to start the self clean cycle.

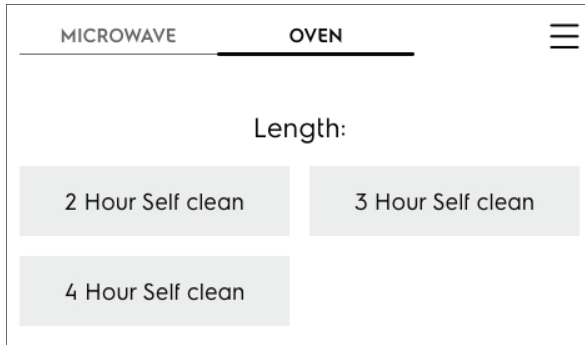

When the oven is set to run a self-clean cycle, the motor door lock will begin locking the oven door. Do not open the oven door while the lock motor is running or when any locking indicators or displays are showing. The oven door is completely locked in about 15 seconds. Once the oven door has locked, CLEAN will appear in the display indicating self clean has started.

Do not force the oven door open when self-clean is active. This can damage the automatic door-locking system. Use caution when opening the door after self-clean cycle is complete; the oven may still be very hot.

When the self clean cycle has completed:

1. **CLEAN** message will turn off, and **Hot** will appear in display window. The oven door will remain locked while the oven cools.
2. Once the oven has cooled down (about 1 hour) and **Hot** is no longer displayed, the oven door may be opened.
3. When the oven interior has completely cooled, wipe away any residue or powdered ash with a damp cloth or paper towel.

Setting Delay Start Self Clean

To start a delay self clean with default clean time of 3 hours.

1. Press **ON/OFF** key and touch **Oven Modes**.
2. Scroll and touch **Delay Start**.

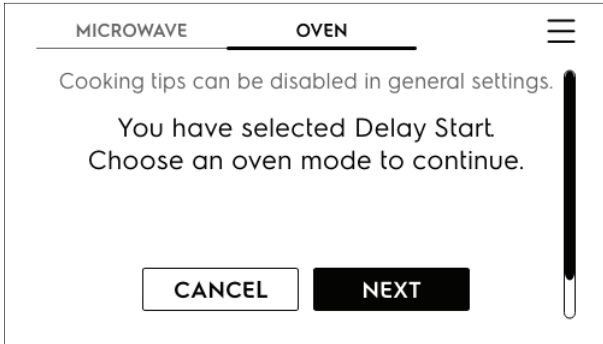

3. Touch **NEXT** and scroll Oven Modes to **Self Clean**. Follow the information on the screen to set delay time, self clean time.



If it becomes necessary to stop self clean when active:

- Press **OFF**.
- If self clean has heated the oven to a high temperature, allow enough time for the oven to cool.
- Before restarting self clean, be sure to read important notes below.

Important notes

- If self clean was active and then interrupted by a power failure or canceled before the oven was thoroughly cleaned, it may be necessary to run another self clean cycle.
- If the oven temperature was high enough when self clean was interrupted the oven control may not allow another self clean cycle to be set for up to 4 hours.

48 SETTING OVEN CONTROLS

Steam Clean

The Steam Clean feature offers a chemical free and time saving method to assist in the routine cleaning of small and light soils. For heavier baked on soils use the Self Clean feature.

CAUTION

Do not add bleach, ammonia, oven cleaner, or any other abrasive household cleaners to the water used for Steam Clean.

Before cleaning any part of the oven, be sure all controls are turned off and the oven is cool. The oven may be hot and can cause burns.

Be sure the oven is level and cool before starting Steam Clean. If the oven temperature is above room temperature a triple beep will be heard and the function will not start. Steam Clean produces best results when started with a cool oven.

To set a Steam Clean cycle:

1. Remove all racks and oven accessories.
2. Scrape or wipe loose debris and grease from the oven bottom.
3. Pour 1 cup of tap water onto the oven bottom. Close oven door.

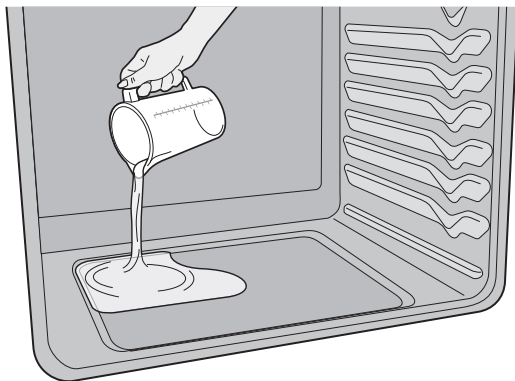

Figure 7: Add 1 cups of tap water

4. Touch **Oven Modes**, scroll to and touch **Steam Clean**.
5. Touch **START**.
6. The time the Steam Clean cycle will end is shown in the display. Do not open the door during this time. If door is open while in Steam Clean (d-O) will appear in the display.
7. When the steam clean cycle is complete an alert will sound and the Off message will show in the display. Press off to return to the clock.

8. Take care opening the door when the steam clean is finished. Stand to the side of the oven out of the way of escaping vapor.
9. Wipe oven cavity and bottom. Do not clean oven door gasket (page 48). Avoid leaning or resting on the oven door glass while cleaning cavity.

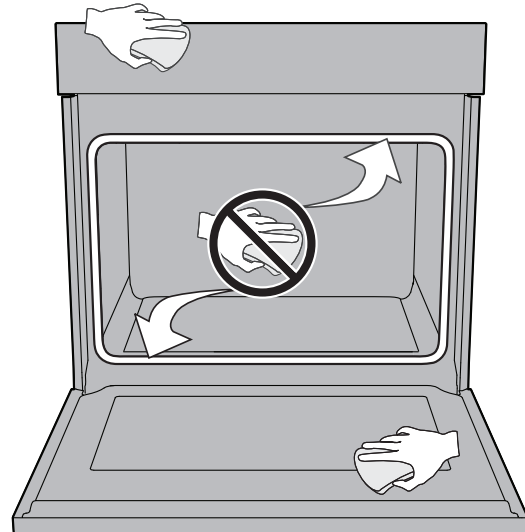

Figure 8: Clean around the oven door gasket

Notes:

- Opening the oven door during the steam clean cycle prevents the water from reaching the temperature needed to clean.
- For best results, clean oven immediately after the cycle is complete. Steam clean works best for soils on the oven bottom.
- A non-abrasive scouring pad, stainless steel sponge, plastic scraper, or eraser style cleaning pad (without cleaner) can be used for difficult soils. Moisten pads with water before use.
- Place a paper towel or cloth in front of the oven to capture any water that may spill while wiping out.
- Do not leave the residual water in the oven for any length of time.
- Some condensation or water vapor may appear close to the oven vent and the oven door glass. This is normal. The oven gasket may become damp; do not wipe dry.
- Local water sources often contain minerals (hard water). If hard water deposits occur, wipe cavity with a 50/50 solution of water and vinegar or 50/50 solution of lemon juice and water.
- Steam clean cannot be programmed with a delayed start time.
- If Steam Clean results are not satisfactory, run a Self Clean. See "Self Clean" on page 45.

About Your Microwave Oven

This Use and Care Manual is valuable: read it carefully and always save it for reference.

A good microwave cookbook is a valuable asset. Check it for microwave cooking principles, techniques, hints, and recipes.

NEVER use the microwave oven without the turntable and support, even if using non-microwave functions like Convection and Top Grill.

NEVER turn the turntable over so that a large dish could be placed in the microwave oven.

The turntable will turn both clockwise and counter-clockwise. **DO NOT** try to turn the turntable by hand.

ALWAYS have food in the microwave oven when it is on to absorb the microwave energy.

When using the microwave oven at power levels below 100%, you may hear the magnetron cycling on and off. It is normal for the exterior of the microwave oven to be warm to the touch when cooking or reheating.

Condensation is a normal part of microwave cooking. Room humidity and the moisture in food will influence the amount of moisture that condenses in the microwave oven. Generally, covered foods will not cause as much condensation as uncovered ones. Ventilation openings must not be blocked.

The microwave oven is for food preparation only. It should not be used to dry clothes or newspapers.

All microwave ovens are rated by using the IEC Test Procedure at 1200 watts. If using recipes or package directions, check food a minute or two before the minimum time setting elapses and add time accordingly.

Radio or TV Interference

Should there be any interference caused by the microwave oven to your radio or TV, check that the microwave oven is on a different electrical circuit, relocate the radio or TV as far away from the microwave oven as feasible or check position and signal of receiving antenna.

About Microwave Cooking

- Arrange food carefully. Place thickest areas towards outside of dish.
- Watch cooking time. Cook for the shortest amount of time indicated and add more as needed. Food severely overcooked can smoke or ignite.
- Cover foods while cooking. Check recipe or cookbook for suggestions: paper towels, wax paper, microwave plastic wrap or a lid. Covers prevent spattering and help foods to cook evenly.
- Stir foods from outside to center of dish once or twice during cooking, if possible.
- Turn foods over once during microwaving to speed cooking of such foods as chicken and hamburgers. Large items like roasts must be turned over at least once.
- Rearrange foods such as meatballs halfway through cooking both from top to bottom and from the center of the dish to the outside.
- Allowing food to stand in or out of the oven after cooking power stops can improve results. Standing time after defrosting or cooking allows the temperature to evenly spread throughout the food.
- Check for doneness. Look for signs indicating that cooking temperatures have been reached. Doneness signs include:
 - Food steams throughout, not just at edge.
 - Center bottom of dish is very hot to the touch.
 - Poultry thigh joints move easily.
 - Meat and poultry show no pinkness.
 - Fish is opaque and flakes easily with a fork.

50 BEFORE USING MICROWAVE

About Foods

CAUTION

- Some products such as whole eggs and sealed containers—for example, closed jars—will explode and should not be heated in this microwave oven. Such use of the microwave oven could result in injury.
- Do not boil eggs in a microwave oven. Pressure will build up inside egg yolk and will cause it to burst, possibly resulting in injury.
- Spontaneous boiling—Under certain special circumstances, liquids may start to boil during or shortly after removal from the microwave oven. To prevent burns from splashing liquid, we recommend the following: before removing the container from the microwave oven, allow the container to stand in the microwave oven for 30 to 40 seconds after the microwave oven has shut off. Do not boil liquids in narrow-necked containers such as soft drink bottles, wine flasks, or especially narrow-necked coffee cups. Even if the container is opened, excessive steam can build up and cause it to burst or overflow.
- Do not defrost frozen beverages in narrow-necked bottles (especially carbonated beverages). Even if the container is opened, pressure can build up. This can cause the container to burst, possibly resulting in injury.
- Hot foods and steam can cause burns. Be careful when opening any containers of hot food, including popcorn bags, cooking pouches and boxes. To prevent possible injury, direct steam away from hands and face.

IMPORTANT

- Operating the microwave with no food inside for more than a minute or two may cause damage to the microwave oven and could start a fire. It increases the heat around the magnetron and can shorten the life of the microwave oven.
- Do not overcook potatoes. They could dehydrate and catch fire, causing damage to your microwave oven.

- Do not pop popcorn in your microwave oven unless in a special microwave popcorn accessory or unless you use popcorn labeled for use in microwave ovens.
- Foods with unbroken outer “skin” -- such as potatoes, hot dogs, sausages, tomatoes, apples, chicken livers and other giblets, and egg yolks -- should be pierced to allow steam to escape during cooking.
- Avoid heating baby food in glass jars, even with the lid off. Make sure all infant food is thoroughly cooked. Stir food to distribute the heat evenly. Be careful to prevent scalding when warming formula or breast milk. The container may feel cooler than the milk really is. Always test the milk before feeding the baby.
- Cook meat and poultry thoroughly—meat to at least an INTERNAL temperature of 160°F and poultry to at least an INTERNAL temperature of 165°F. Cooking to these temperatures usually protects against food-borne illness.

About Utensils and Coverings

It is not necessary to buy all new cookware. Many pieces already in your kitchen can be used successfully in your new microwave oven. Make sure the utensil does not touch the interior walls during cooking.

Use these utensils for safe microwave cooking and reheating:

- glass ceramic (Pyroceram®), such as Corningware®
- heat-resistant glass (Pyrex®)
- microwave-safe plastics
- paper plates
- microwave-safe pottery, stoneware and porcelain
- browning dish (Do not exceed recommended preheating time. Follow manufacturer’s directions.)

These items can be used for short-time reheating of foods that have little fat or sugar in them:

- wood, straw, wicker

DO NOT USE

- metal pans and bakeware
- dishes with metallic trim
- non-heat-resistant glass
- non-microwave-safe plastics (margarine tubs)
- recycled paper products
- brown paper bags
- food storage bags
- metal twist-ties
- styrofoam

Should you wish to check if a dish is safe for microwaving, place the empty dish in the microwave oven and microwave on HIGH for 30 seconds. A dish which becomes very hot should not be used.

The following coverings are suitable for microwave use:

- Paper towels are good for covering foods for reheating and absorbing fat while cooking bacon.
- Wax paper can be used for cooking and reheating.
- Plastic wrap that is specially marked for microwave use can be used for cooking and reheating. DO NOT allow plastic wrap to touch food. Vent so steam can escape.
- Lids that are microwave-safe are a good choice because heat is kept near the food to hasten cooking.
- Oven cooking bags are good for large meats or foods that need tenderizing. DO NOT use metal twist ties. Remember to slit bag so steam can escape.

Included

The microwave comes with one rack and one rotating tray.

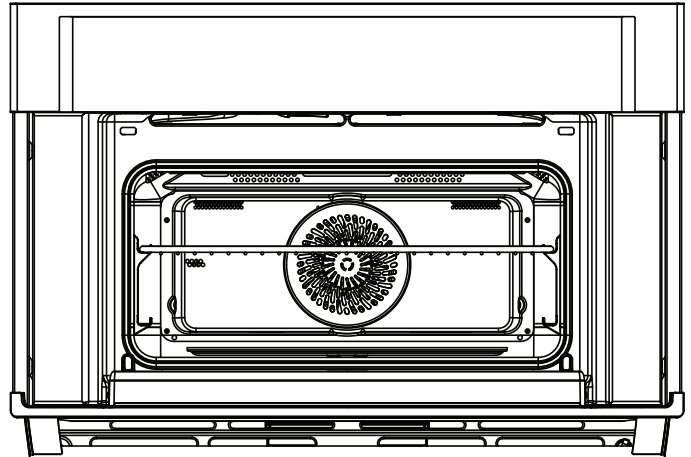
**Additional Accessories**

There are many microwave accessories available for purchase. Evaluate carefully before you purchase so that they meet your needs. A microwave-safe thermometer will assist you in determining correct doneness and assure you that foods have been cooked to safe temperatures.

The manufacturer is not responsible for any damage to the microwave oven when accessories are used.

52 BEFORE USING MICROWAVE

About Children and the Microwave

Children below the age of 7 should use the microwave oven with a supervising person very near to them. Between the ages of 7 and 12, the supervising person should be in the same room.

At no time should anyone be allowed to lean or swing on the microwave oven door.

Children should be taught all safety precautions: use pot holders, remove coverings carefully, pay special attention to packages that crisp food because they may be extra hot.

Don't assume that because a child has mastered one cooking skill he/she can cook everything.

Children need to learn that the microwave oven is not a toy.

About Food Safety

Check foods to see that they are cooked to the United States Department of Agriculture's recommended temperatures.

To test for doneness, insert a meat thermometer in a thick or dense area away from fat or bone. Never leave the thermometer in the food during cooking, unless it is approved for microwave oven use.

CAUTION

- ALWAYS use pot holders to prevent burns when handling utensils that are in contact with hot food. Enough heat from the food can transfer through utensils to cause skin burns.
- Avoid steam burns by directing steam away from the face and hands. Slowly lift the farthest edge of a dish's covering and carefully open popcorn and oven cooking bags away from the face.

Note:

- Stay near the microwave oven while it's in use and check cooking progress frequently so that there is no chance of overcooking food.
- NEVER use the cavity for storing cookbooks or other items.
- Select, store, and handle food carefully to preserve its high quality and minimize the spread of food-borne bacteria.
- Keep the waveguide cover clean. Food residue can cause arcing and/or fires.
- Use care when removing items from the microwave oven so the utensil, your clothes, or accessories do not touch the safety door latches.

Preparing Food for Microwave Cooking

To avoid injury or damage to your appliance and to minimize cleaning, prepare food for microwave cooking as shown in Table 7.

Table 7: Preparing food for microwave

Food	Amount	Procedure									
Popcorn	1 package 1.5 - 3.5 oz bag	Use only popcorn packaged for microwave oven use. Try several brands to decide which you like. Do not try to pop unpopped kernels. Use Popcorn feature.									
Reheat Casserole Entree	8-10 oz 2-3 servings	Place food in casserole dish slightly larger than amount to be reheated. Cover with vented microwave-safe lid, plastic wrap, or wax paper. Use covers such as plastic wrap or lids with larger quantities of more dense foods such as stews. After reheating, stir well, if possible. Foods should be hot. If not, continue to heat using +30 to add more cook time.									
Baked Potato	2 or 4 (8 oz - 12 oz)	Wash and dry. Pierce at both ends and in center. Place on turntable. Foods with unbroken outer "skin" -- such as potatoes -- should be pierced to allow steam to escape during cooking									
Fresh Veggie: Asparagus Broccoli Cauliflower (florets) Carrots, baby Carrots, sliced Corn	1 lb 2 cups 2 cups 2 cups 2 cups 2 cups	Wash and place in casserole dish. Add 2 tbsp of water. Cover with vented microwave-safe lid or plastic wrap. Stir after cooking.									
Frozen Veggie	2 cups	Add no water. Cover with vented lid or plastic wrap. Use Veg-gies feature. After cooking, stir.									
Rice	1-2 cups	Place rice into a deep casserole dish and add double quantity of water (see below). Cover with lid or plastic wrap; do not vent. After cooking, let stand 5 minutes or until all liquid has been absorbed. <table style="width: 100%; border: none;"> <tr> <td style="text-align: left;">Rice</td> <td style="text-align: left;">Water</td> <td style="text-align: left;">Size of casserole</td> </tr> <tr> <td>1 cup</td> <td>2 cups</td> <td>2 quart</td> </tr> <tr> <td>2 cups</td> <td>4 cups</td> <td>3 quart or larger</td> </tr> </table>	Rice	Water	Size of casserole	1 cup	2 cups	2 quart	2 cups	4 cups	3 quart or larger
Rice	Water	Size of casserole									
1 cup	2 cups	2 quart									
2 cups	4 cups	3 quart or larger									

54 SETTING MICROWAVE CONTROLS

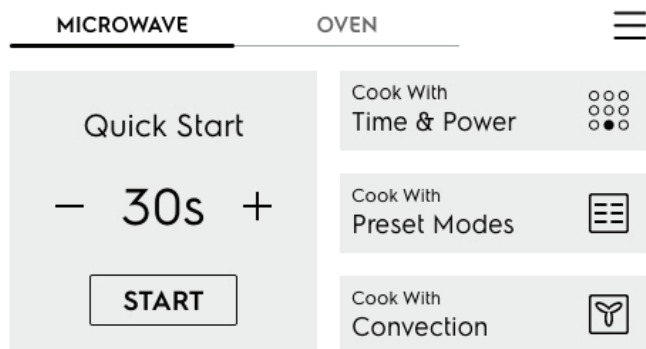

Quick Start

When **ON/OFF** is pressed the display opens to the Quick Start screen. Select the Microwave tab to use the microwave functions.

From the Quick Start screen, you can immediately start the microwave on High for 30 seconds by pressing **START**. You can adjust the time by pressing **+** or **-**.

Time & Power

1. Press **Cook with Time & Power**.

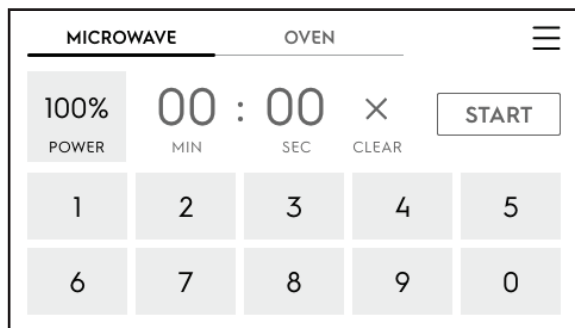

2. To change the power setting press **Power**.
3. Specify the desired power level in the Power Level screen.

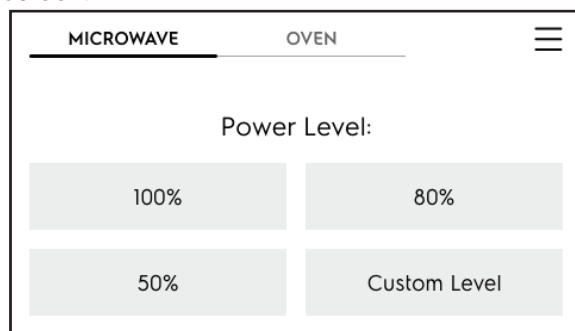

4. Enter the desired cook time using the number keys.
5. Press **START**

Preset Modes

The microwave has ten preset modes to make cooking easier.

1. Press **Cook with Preset Modes**.
2. Press the key for the Preset Mode you want to use.

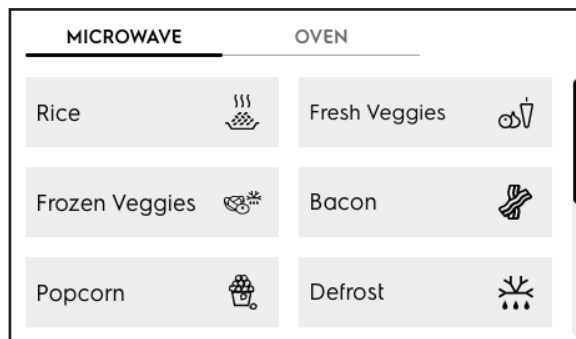

3. Some Preset Modes (such as Fresh Veggies) require you to specify the type of food. Press the corresponding key to select the type of food.
4. Most Preset Modes require you to specify the amount of food. Press the key that best matches the amount you are cooking.
5. The final screen will show the mode, amount, and cook time. You can adjust the cook time with the **+** and **-** keys.
6. Press **START**.

Convection

For best results, allow the microwave to fully preheat before cooking.

1. Place food on Rack 1.
2. Press **Cook with Convection**.

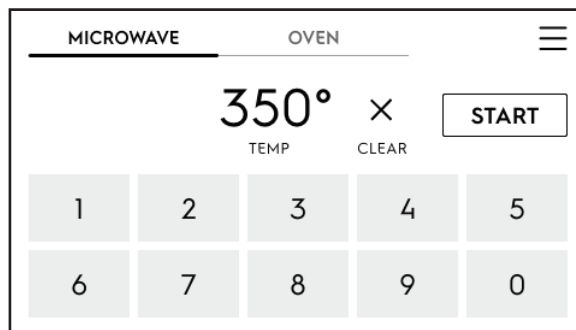

3. Specify the desired temperature using the number keys.
4. Press **START**.

Rice Mode

Rice Mode cooks: 1 or 2 cups of dry white rice with the appropriate amount of water.

Use a large (4 quarts) covered microwave-safe dish to prevent spillover.

1. Press **Cook with Preset Modes**.
2. Press the **Rice** key.
3. Press the key that best matches the amount of rice you are cooking.
4. The final screen will show the mode, amount, and cook time. You can adjust the cook time with the **+** and **-** keys.

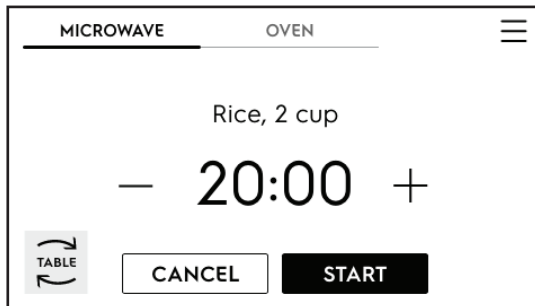

5. Press **START**.

Fresh Veggies Mode

Fresh Veggies Mode works best for potatoes, yams, and other fresh vegetables.

Baked Potato: Cook 8 to 12 ounce fresh potatoes. Pierce each potato with fork once in center and at each end.

Baked Yam: Cook 8 to 12 ounce fresh yams. Pierce each yam with fork once in center and at each end.

Fresh Veggies (other than potatoes or yams): Add 2 tablespoons water to veggies and use a 1.5 quarts vented or loosely-covered microwave-safe dish.

1. Press **Cook with Preset Modes**.
2. Press the **Fresh Veggies** key.
3. Press the key that matches the type of food you are cooking.

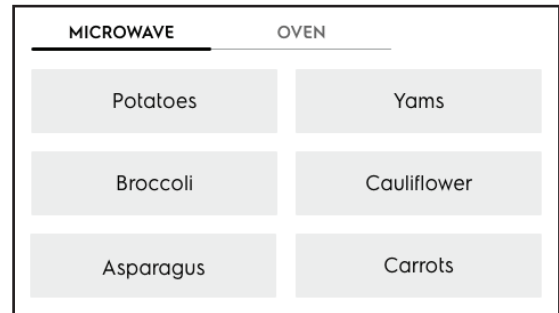

4. Press the key that best matches the amount you are cooking.
5. The final screen will show the mode, amount, and cook time. You can adjust the cook time with the **+** and **-** keys.
6. Press **START**.

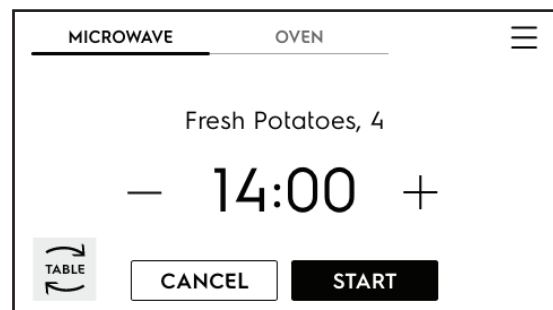

56 SETTING MICROWAVE CONTROLS

Frozen Veggies Mode

For best results, use a 1.5 quarts vented or loosely-covered microwave-safe dish.

1. Press **Cook with Preset Modes**.
2. Press the **Frozen Veggies** key.
3. Press the key that matches the type of food you are cooking.
4. Press the key that best matches the amount you are cooking.
5. The final screen will show the mode, amount, and cook time. You can adjust the cook time with the **+** and **-** keys.

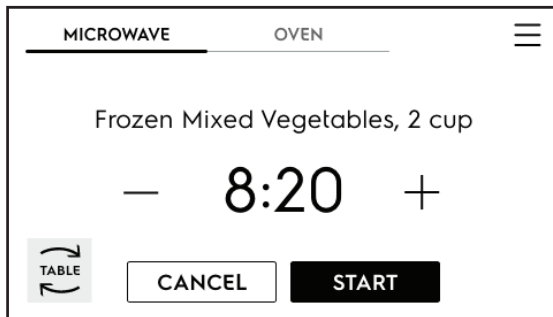

6. Press **START**.

Bacon Mode

For best results, cook thick slices of bacon in a microwave-safe tray.

1. Press **Cook with Preset Modes**.
2. Press the **Bacon** key.
3. Press the key that best matches the amount you are cooking.
4. The final screen will show the mode, amount, and cook time. You can adjust the cook time with the **+** and **-** keys.

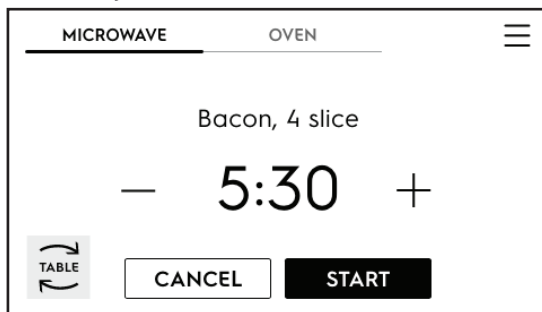

5. Press **START**.

Popcorn Mode

Use microwave popcorn. Refer to popcorn packaging for size.

1. Press **Cook with Preset Modes**.
2. Press the **Popcorn** key.
3. Press the key that best matches the amount you are cooking.
 - Small - under 2 ounces
 - Medium - 2-3 ounces
 - Large - 3 ounces or more
4. The final screen will show the mode, amount, and cook time.

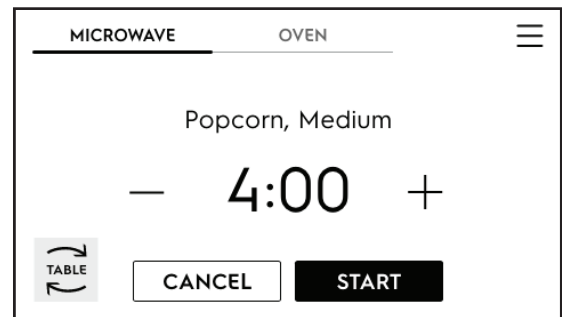

5. Press **START**.
6. Listen for pops to slow and stop or extend cooking if needed. You can adjust the cook time with the **+** and **-** keys.

Defrost Mode

Defrost meat or poultry on a microwave-safe defrosting tray. Halfway through Defrost time, the microwave will beep to prompt turning the food.

1. Press **Cook with Preset Modes**.
2. Press the **Defrost** key.
3. Press the key that matches the type of food you are cooking.
4. Press the key that best matches the amount you are cooking.
5. The final screen will show the mode, amount, and cook time. You can adjust the cook time with the **+** and **-** keys.

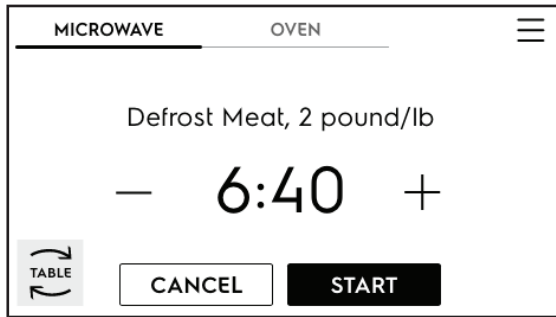

6. Press **START**.

Melt Mode

Use Melt Mode to melt foods like chocolate.

1. Press **Cook with Preset Modes**.
2. Press the **Melt** key.
3. Press the key that matches the type of food you are cooking.
4. Press the key that best matches the amount you are cooking.
5. The final screen will show the mode, amount, and cook time.



6. Press **START**.
7. Stir chocolate when removed from microwave.

Soften Mode

Use Soften Mode to soften foods like butter.

1. Press **Cook with Preset Modes**.
2. Press the **Soften** key.
3. Press the key that best matches the amount you are cooking.
4. The final screen will show the mode, amount, and cook time. You can adjust the cook time with the **+** and **-** keys.

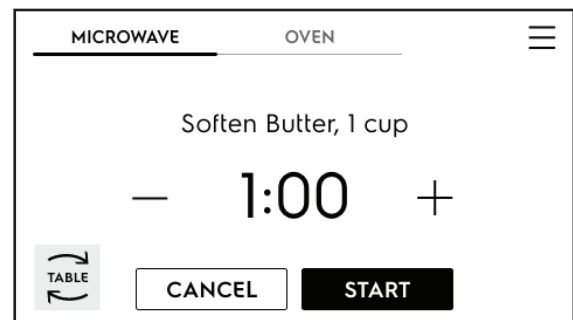

5. Press **START**.
6. Stir butter when removed from microwave.

58 SETTING MICROWAVE CONTROLS

Reheat Mode

Use Reheat Mode to reheat foods that were previously cooked.

Reheat Casserole: Reheat Casserole amounts between 8 and 10 ounces.

Reheat Entrée: Reheat Entrée amounts between 2 and 3 servings; larger sizes or more dense foods may need additional time. Loosely cover the entrée before cooking.

1. Press **Cook with Preset Modes**.
2. Press the **Reheat** key.

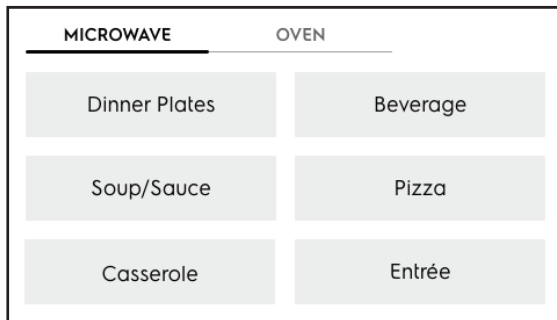

3. Press the key that matches the type of food you are cooking.
4. Press the key that best matches the amount you are cooking.
5. The final screen will show the mode, amount, and cook time.
6. Press **START**.

Top Grill Mode

Use Top Grill mode for toasting bread, melting cheese, and other light broiling.

1. For meat, use Rack 2. For bread, use upper rack.
2. Press **Cook with Preset Modes**.
3. Press the **Top Grill** key.

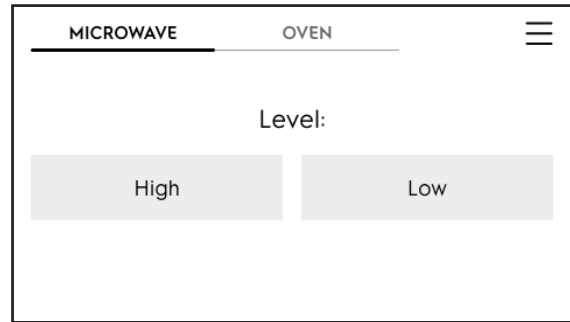

4. Select **High** or **Low** heating by pressing the appropriate key.
5. For meat, allow 8 minutes to preheat. Preheating is not necessary for toasting bread.
6. The final screen will show the mode and **Cancel**.
7. Press **START**.

Microwave suitable cookware and materials

For the microwave, use only suitable cookware and materials. Use the table below as a reference.

Cookware / Material	Defrost	Reheat, Liquid	Convection, Top Grill
Ovenproof glass and porcelain with no metal components, e.g. heat-proof glass	✓	✓	✓
Non-ovenproof glass and porcelain without any silver, gold, platinum or other metal decorations	✓	X	X
Glass and glass ceramic made of ovenproof / frost-proof material	✓	✓	✓
Ceramic and earthenware without any quartz or metal components and glazes which contain metal	✓	✓	X
Ceramic, porcelain and earthenware with unglazed bottom or with small holes, e.g. on handles	X	X	X
Heat-resistant plastic up to 392 °F (200 °C) Always check the plastic container specification before use.	✓	✓	X
Cardboard, paper	✓	X	X
Clingfilm	✓	X	X
Roasting film with microwave safe closure (please always check the film specification before use)	✓	✓	X
Roasting dishes made of metal, e.g. enamel, cast iron	X	X	X
Baking tins, black lacquer or silicon-coated (please always check the baking tins specification before use)	X	X	X
Baking tray	X	X	X
Wire shelf	X	X	✓
Cookware for microwave use, e.g. crisp pan	X	✓	X

60 CARE AND CLEANING

Remove spills and any heavy soiling as soon as possible. Regular cleaning will reduce the difficulty of major cleaning later.

CAUTION

Before cleaning any part of the appliance, be sure all controls are turned off and the appliance is cool.

If ammonia or appliance cleaners are used, they must be removed and the appliance must be thoroughly rinsed before operating. Follow manufacturer's instructions and provide adequate ventilation.

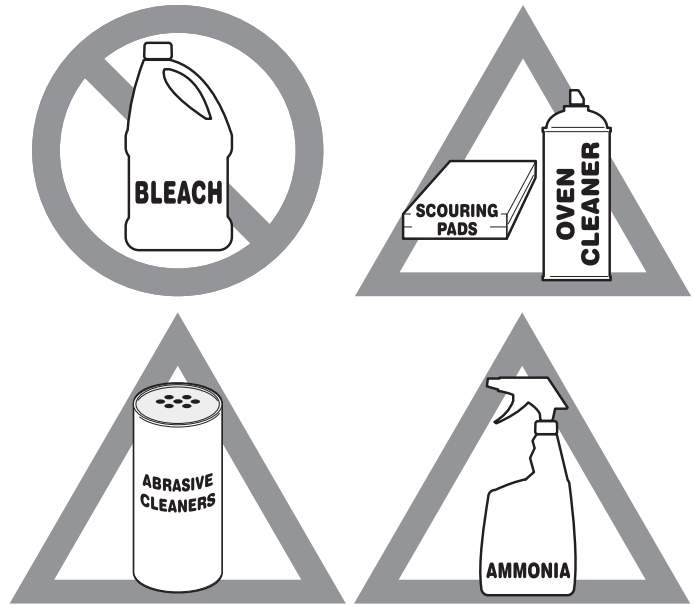

Figure 9: Use cleaners with caution

Surface or Area	Cleaning Recommendation
Aluminum and vinyl	Using a soft cloth, clean with mild dish detergent and water. Rinse with clean water, dry and polish with a soft, clean cloth.
Painted body parts Painted decorative trims	Using a soft cloth, clean with mild dish detergent and water or a 50/50 solution of vinegar and water. Rinse with clean water, dry and polish with a soft, clean cloth. Glass cleaners may be used, but do not apply directly to surface; spray onto cloth and wipe.
Touch display	Using a soft cloth, clean with mild dish detergent and water or a 50/50 solution of vinegar and water. Do not spray liquids directly on the display area. Do not use large amounts of water on the display - excess water may cause damage to the appliance. Do not use other liquid cleaners, abrasive cleaners, scouring pads, or paper towels - they may damage the finish.
Control panel	Using a soft cloth, clean with mild dish detergent and water or a 50/50 solution of vinegar and water. Do not spray liquids directly on the oven control and display area. Do not use large amounts of water on the control panel - excess water on the control area may cause damage to the appliance. Do not use other liquid cleaners, abrasive cleaners, scouring pads, or paper towels - they will damage the finish.
Control knobs	Using a soft cloth, clean with mild dish detergent and water or a 50/50 solution of vinegar and water. To remove control knobs: turn to the OFF position, grasp firmly, and pull off the shaft. To replace knobs after cleaning, line up the OFF markings and push the knobs into place.
Stainless Steel	Using a soft cloth, clean with mild dish detergent and water or a 50/50 solution of vinegar and water. Rinse with clean water, dry with a soft clean cloth. Do not use cleaners containing abrasives, chlorides, chlorine, or ammonia.
Coated Stainless Steel	Using a soft cloth, clean with mild dish detergent and water or a 50/50 solution of vinegar and water. Rinse with clean water, dry with a soft clean cloth. Do not use appliance cleaner, stainless steel cleaner, or cleaner containing abrasives, chlorides, chlorine, or ammonia. These cleaners may damage the finish.

Surface or Area	Cleaning Recommendation
Porcelain-enameled broiler pan and insert Porcelain door liner Porcelain body parts	Rinse with clean water and a damp cloth. Scrub gently with a soapy, non-abrasive scouring pad to remove most spots. Rinse with a 50/50 solution of clean water and ammonia. If necessary, cover difficult spots with an ammonia-soaked paper towel for 30 to 40 minutes. Rinse and wipe dry with a clean cloth. Remove all cleaners or future heating could damage the porcelain. Do not allow food spills with a high sugar or acid content (milk, tomatoes, sauerkraut, fruit juices or pie filling) to remain on porcelain surfaces. These spills may cause a dull spot even after cleaning.
Self-cleaning oven interior	Before setting a self-clean cycle, clean soils from the oven frame, areas outside the oven door gasket, and the small area at the front center of the oven bottom. "Figure 13: Removal position" on page 65.
Oven door	<p>Use mild dish detergent and water or a 50/50 solution of vinegar and water to clean the top, sides, and front of the oven door. Rinse well. Glass cleaner may be used on the outside glass of the door. Ceramic smoothtop cleaner or polish may be used on the interior door glass. Do not immerse the door in water. Do not spray or allow water or cleaners to enter the door vents. Do not use oven cleaners, cleaning powders, or any harsh abrasive cleaning materials on the outside of the oven door.</p> <p>Do not clean the oven door gasket. The oven door gasket is made of a woven material which is essential for a good seal. Do not rub, damage, or remove this gasket.</p>

62 CARE AND CLEANING

General Cleaning

Refer to the table at the beginning of this chapter for more information about cleaning specific parts of the oven.

Follow these cleaning precautions:

- Allow the oven to cool before cleaning.
- Wear rubber gloves when cleaning the appliance manually.

Remove soils using hot, soapy water. Do not allow food spills with a high sugar or acid content (such as milk, tomatoes, sauerkraut, fruit juices or pie filling) to remain on the surface as they may cause a dull spot even after cleaning. Remove spillovers and heavy soiling as soon as possible. Regular cleaning will reduce the effort required for major cleaning later.



CAUTION

Before manually cleaning any part of the oven, be sure all controls are turned off and the oven is cool. The oven may be hot and can cause burns.

Remove all racks and accessories from the oven before cleaning.

Ammonia must be rinsed before operating the oven. Provide adequate ventilation.

Cleaning Porcelain Enamel Oven

The oven interior is porcelain on steel, it is safe to clean using oven cleaners.

To remove heavy soil:

1. Allow a dish of ammonia to sit in the oven overnight or for several hours with the oven door closed. Clean softened dirt spots using hot, soapy water. Rinse well with water and a clean cloth.
2. If soil remains, use a nonabrasive scouring pad or a nonabrasive cleaner. If necessary, use an oven cleaner following manufacturer's instructions. Do not mix ammonia with other cleaners.
3. Clean any soil from the oven frame, the door liner outside the oven door gasket and the small area at the front center of the oven bottom. Clean with hot, soapy water. Rinse well using clean water and a cloth.

Aluminum Foil, Aluminum Utensils, and Oven Liners

! WARNING

Never cover any slots, holes, or passages in the oven bottom or cover an entire oven rack with materials such as aluminum foil. Doing so blocks air flow through the oven and may cause carbon monoxide poisoning. Aluminum foil linings may trap heat, causing a fire hazard.

- Protective liners—Do not use aluminum foil to line the oven bottom. The high heat of the oven can melt these materials to the oven cavity and ruin the oven. These types of materials can also reduce the effectiveness of the air circulation in the oven and produce poor baking results. Only use aluminum foil as recommended in this manual. Improper installation of these liners may result in risk of electric shock or fire.
- Aluminum utensils - The melting point of aluminum is much lower than that of other metals. Care must be taken when aluminum pots or pans are used.
- Oven racks - Do not use aluminum foil to cover the oven racks. Using a liner in the oven restricts the heat and air flow needed to obtain the best possible cooking results for any oven.

Replacing the Oven Light

! CAUTION

Be sure the oven is unplugged and all parts are cool before replacing the oven light.

The interior oven light is located at the rear of the oven cavity and is covered by a glass shield. The glass shield must be in place whenever the oven is in use.

To replace the oven interior light bulb:

1. Turn electrical power off at the main source or unplug the appliance.
2. Remove interior oven light shield by turning a quarter turn counter-clockwise.
3. Replace bulb with a new T-4 type Halogen 25 watt appliance bulb.

➔ NOTE

Wear a cotton glove or use a paper towel when installing a new bulb. Do not touch the new bulb with your fingers when replacing. This will shorten the life of the bulb.

4. Replace glass oven light shield by rotating clockwise.
5. Turn power back on again at the main source (or plug the appliance back in).
6. Be sure to reset the time of day on the clock.

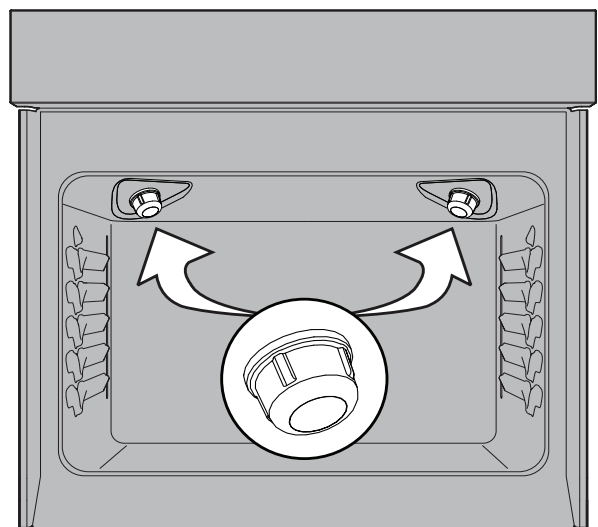

Figure 10: Wall oven Halogen light

64 CARE AND CLEANING

Caring for Your Glide Racks

Caution: Handle oven racks only when they are cool. After cooking or after the fresh-clean cycle, racks will be very hot and can cause burns.

Important Notes:

- Remove all oven racks, including ladder racks, before starting a clean cycle.
- Do not use cooking oil, cooking spray, or other oil-based lubrication products on the glide rack extension tracks. Use only the graphite lubrication in this area. To order graphite lubrication, contact your installer, servicer or dealer.
- It is important that the parts of the rack that contact the oven sides always have a light coating of vegetable oil. Apply a thin layer of vegetable oil to the sides of the rack after every fresh-clean cycle and when the rack becomes difficult to reposition in the oven.

To lubricate the glide rack:

1. Remove the rack from the oven and place the rack on a large flat surface covered with newspaper or scrap cloth. Fully extend the rack.
2. Wipe away debris and crumbs from the glide track using a cloth or sponge.

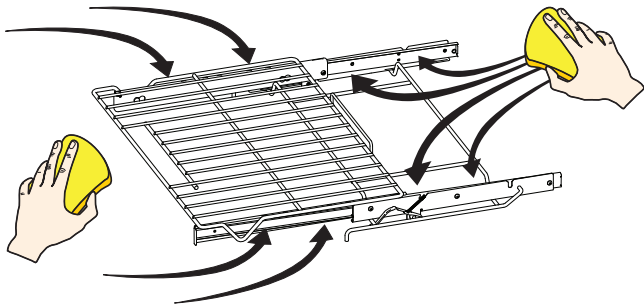

3. Shake graphite lubrication very well before applying. Apply to loading guides, and rotation pin. Repeat on both sides of the glide rack.

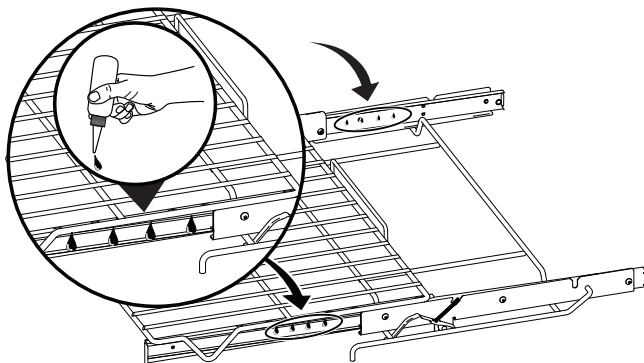

4. Extend and return the glide rack several times along the tracks to distribute the lubrication.

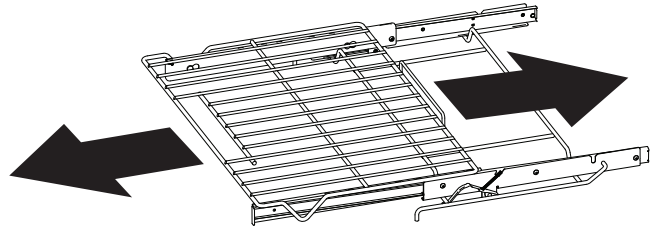

5. Turn the rack upside down and apply graphite lubrication to the insides of the loading guides.

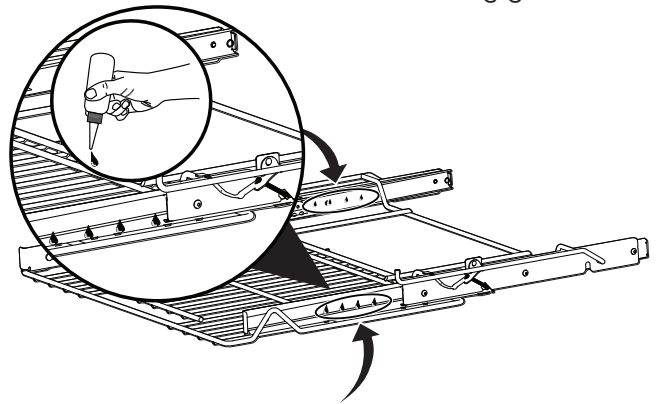

6. Extend and return the glide rack several times along the tracks to distribute the lubrication.
7. Apply a thin layer of cooking oil to the bottom of the "V" and the glide channels. Keeping the frame sides lightly lubricated allows the entire rack to slide easily when changing rack positions.
8. Replace rack in oven right-side up.

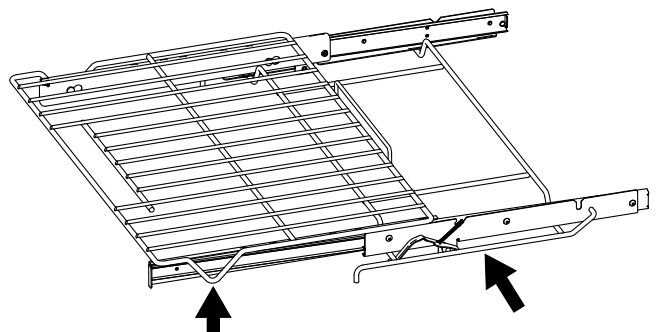

Removing and Replacing the Oven Door

CAUTION

The door is heavy. For safe, temporary storage, lay the door flat with the inside of the door facing down.

IMPORTANT

Special door care instructions - For safe, temporary storage, lay the door flat with the inside of the door facing down.

Most oven doors contain glass that can break. Do not hit the glass with pots, pans, or any other object. Scratching, hitting, jarring, or stressing the glass may weaken its structure, causing an increased risk of breakage at a later time. Do not close the oven door until all of the oven racks are fully in place.

To remove the oven door:

1. Open oven door completely, horizontal with floor (Figure 11).
2. Pull up the lock located on each hinge support toward front of the oven until the lock stops. You may have to apply a little upward pressure on the lock to pull it up (Figure 12).
3. Grasp the door by the sides, and close the door until the door frame makes contact with the unlocked hinges (Figure 13).
4. Pull the bottom of the door toward you while rotating the top of the door toward the appliance to completely disengage the hinge levers (Figure 14).

To replace the oven door:

1. Firmly grasp both sides of oven door along the door sides. Do not use the oven door handle (Figure 14).
2. Hold the oven door at the same angle as the removal position (Figure 13). Carefully insert the hinge levers into the oven frame until you feel the hinge levers are seated into the hinge notches. The hinge arms must be fully seated into the hinge notches before the oven door can be fully opened.
3. Fully open the oven door, horizontal with floor (Figure 11).
4. Push the door hinge locks up toward and into the oven frame on both left and right oven door hinges to the locked position (Figure 12).
5. Close the oven door.

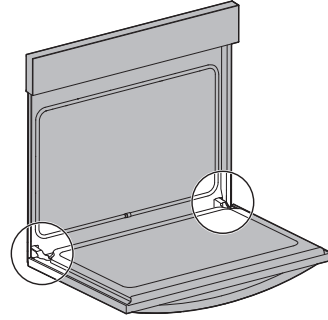

Figure 11: Door hinge location

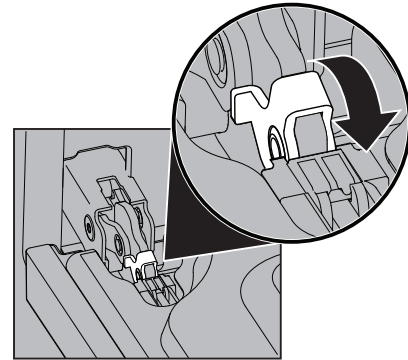

Figure 12: Door hinge lock

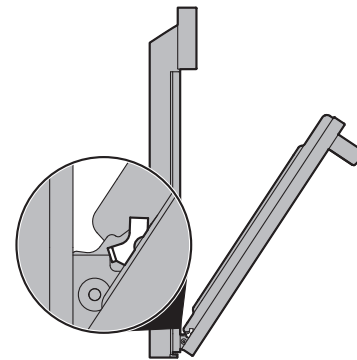

Figure 13: Removal position

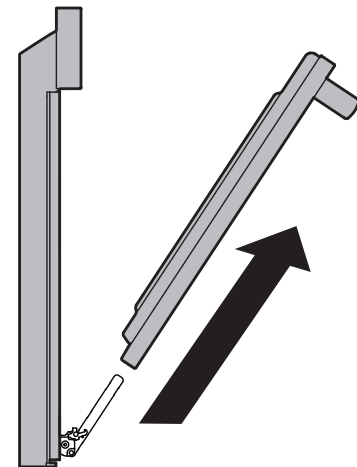







Figure 14: Remove door

66 BEFORE YOU CALL

Oven Baking

For best cooking results, preheat the oven before baking cookies, breads, cakes, pies, pastries, etc. There is no need to preheat the oven for roasting meat or baking casseroles. The cooking times and temperatures needed to bake a product may vary slightly from your previously owned appliance.

Baking Problems and Solutions Baking Problems		
Baking Problems	Causes	Corrections
Cookies and biscuits burn on the bottom. 	Cookies and biscuits put into oven before oven is preheated.	Allow oven to preheat to desired temperature before placing food in oven. Choose pan sizes that will permit at least 2" of air space.
Cakes too dark on top or bottom 	Cakes put in oven before oven is preheated. Rack position too high or too low. Oven too hot.	Allow oven to preheat to the selected temperature before placing food in the oven. Use proper rack position for baking needs. Set oven temperature 25°F (13°C) lower than recommended.
Cakes not done in center 	Oven too hot. Incorrect pan size. Pan not centered in oven. Glass cookware slow heat conductor.	Set oven temperature 25°F (13°C) lower than recommended. Use pan size suggested in recipe. Use proper rack position and place pan so there are at least 2" (5.1 cm) of space on all sides of pan. Reduce temperature and increase cook time or use shiny bakeware.
Cakes not level. 	Oven not level. Pan too close to oven wall or rack overcrowded. Pan warped. Oven light left on while baking.	Place a marked glass measuring cup filled with water on the center of the oven rack. If the water level is uneven, refer to the installation instructions for leveling the oven. Use proper rack position and place pan so there are at least 2" (5.1 cm) of space on all sides of pan. Do not use pans that are dented or warped. Do not leave the oven light on while baking.
Foods not done when cooking time is over. 	Oven too cool. Oven overcrowded. Oven door opened too frequently.	Set oven temperature 25°F (13°C) higher than suggested and bake for the recommended time. Be sure to remove all pans from the oven except the ones to be used for baking. Open oven door only after the shortest recommended baking time.

Let us help you troubleshoot your concern! This section will help you with common issues. If you need us, visit our website, chat with an agent, or call us. We may be able to help you avoid a service visit. If you do need service, we can get that started for you!

1-877-435-3287 (United States)
ElectroluxAppliances.com

1-800-265-8352 (Canada)
ElectroluxAppliances.ca

Problem	Cause / Solution
Entire appliance does not operate	Appliance not connected. Make sure power cord is plugged properly into outlet. Check your fuse box or breaker box to make sure the circuit is active. Electrical power outage. Check house lights to be sure. Call your local electric company for service outage information.

Oven Problems	
Problem	Cause / Solution
Poor baking results.	Many factors affect baking results. Use proper oven rack position. Center food in the oven and space pans to allow air to circulate. Preheat the oven to the set temperature before placing food in the oven. Try adjusting the recipe's recommended temperature or baking time. See "Oven Temperature Calibration" on page 19 if you feel the oven is too hot or too cool.
Flames inside oven or smoking from oven vent	Excessive spills in oven. Grease or food spilled onto the oven bottom or oven cavity. Wipe up excessive spills before starting the oven. If flames or excessive smoke are present when using broil, see "Setting Broil" on page 34.
Oven smokes excessively when broiling.	Incorrect setting. Follow the "Setting Broil" on page 34. Meat too close to the broil element or burner. Reposition the broil pan to provide proper clearance between the meat and broil element or burner. Remove excess fat from meat. Cut remaining fatty edges to prevent curling, but do not cut into lean. Grease build up on oven surfaces. Regular cleaning is necessary when broiling frequently. Grease or food splatters will cause excessive smoking.
Convection fan does not rotate.	Oven door is open. The convection fan will turn off if the oven door is opened when convection is active. Close the oven door.

Wi-Fi Problems	
Problem	Cause / Solution
Trouble with wireless network signal.	Check your wireless network and router. Restart the router.
New router installed or router configuration changed.	To configure oven and mobile device again, refer to "Before first use" chapter, Wireless connection.
The wireless network signal is weak.	Move router as close to the oven as possible.
The wireless signal is disrupted by a microwave appliance placed near the oven.	Turn off the microwave appliance.

68 BEFORE YOU CALL

Self-Clean Problems	
Problem	Cause / Solution
Self clean does not work.	Oven control not set properly. See "Self Clean" on page 45.
Oven racks discolored or do not slide easily.	Oven racks left in oven cavity during self clean. Remove oven racks from oven cavity before starting a self-clean cycle. Clean by using a mild abrasive cleaner following manufacturer's instructions. Rinse with clean water, dry, and replace in oven.
Soil not completely removed after self clean.	Self clean was interrupted. Review instructions on "Self Clean" on page 45. Excessive spills on oven bottom. Remove excessive spills before starting self clean. Failure to clean soil from the oven frame, the door liner outside the oven door gasket, and the small area at the front center of the oven bottom. These areas are not in the self-cleaning area, but get hot enough to burn on residue. Clean these areas before starting the self-cleaning cycle. Burned-on residue can be cleaned with a stiff nylon brush and water or a nylon scrubber. Be careful not to damage the oven gasket.

Other Problems	
Problem	Cause / Solution
Appliance is not level.	Poor installation. Place the oven rack in the center of the oven. Place a level on the oven rack. Adjust the leveling legs at the base of the appliance until the rack is level. Kitchen cabinet alignment may make range appear not level. Be sure cabinets are square and have sufficient room for appliance clearance.
Cannot move appliance easily. Appliance must be accessible for service.	Cabinets not square or are built in too tightly. Contact the builder or installer to make the appliance accessible.
Oven light does not work.	Be sure the oven light is secure in the socket. See "Replacing the Oven Light" on page 63.

Your appliance is covered by a one year limited warranty. For one year from your original date of purchase, Electrolux will pay all costs for repairing or replacing any parts of this appliance that prove to be defective in materials or workmanship when such appliance is installed, used and maintained in accordance with the provided instructions.

Exclusions

This warranty does not cover the following:

Products with original serial numbers that have been removed, altered or cannot be readily determined.

Product that has been transferred from its original owner to another party or removed outside the USA or Canada.

Rust on the interior or exterior of the unit

Products purchased "as-is" are not covered by this warranty.

Food loss due to any refrigerator or freezer failures.

Products used in a commercial setting.

Service calls which do not involve malfunction or defects in materials or workmanship, or for appliances not in ordinary household use or used other than in accordance with the provided instructions.

Service calls to correct the installation of your appliance or to instruct you how to use your appliance.

Expenses for making the appliance accessible for servicing, such as removal of trim, cupboards, shelves, etc., which are not a part of the appliance when it is shipped from the factory.

Service calls to repair or replace appliance light bulbs, air filters, water filters, other consumables, or knobs, handles, or other cosmetic parts.

Surcharges including, but not limited to, any after hour, weekend, or holiday service calls, tolls, ferry trip charges, or mileage expense for service calls to remote areas, including the state of Alaska.

Damages to the finish of appliance or home incurred during installation, including but not limited to floors, cabinets, walls, etc.

Damages caused by: services performed by unauthorized service companies; use of parts other than genuine Electrolux parts or parts obtained from persons other than authorized service companies; or external causes such as abuse, misuse, inadequate power supply, accidents, fires, or acts of God.

DISCLAIMER OF IMPLIED WARRANTIES; LIMITATION OF REMEDIES

CUSTOMER'S SOLE AND EXCLUSIVE REMEDY UNDER THIS LIMITED WARRANTY SHALL BE PRODUCT REPAIR OR REPLACEMENT AS PROVIDED HEREIN. CLAIMS BASED ON IMPLIED WARRANTIES, INCLUDING WARRANTIES OF MERCHANTABILITY OR FITNESS FOR A PARTICULAR PURPOSE, ARE LIMITED TO ONE YEAR OR THE SHORTEST PERIOD ALLOWED BY LAW, BUT NOT LESS THAN ONE YEAR. ELECTROLUX SHALL NOT BE LIABLE FOR CONSEQUENTIAL OR INCIDENTAL DAMAGES SUCH AS PROPERTY DAMAGE AND INCIDENTAL EXPENSES RESULTING FROM ANY BREACH OF THIS WRITTEN LIMITED WARRANTY OR ANY IMPLIED WARRANTY. SOME STATES AND PROVINCES DO NOT ALLOW THE EXCLUSION OR LIMITATION OF INCIDENTAL OR CONSEQUENTIAL DAMAGES, OR LIMITATIONS ON THE DURATION OF IMPLIED WARRANTIES, SO THESE LIMITATIONS OR EXCLUSIONS MAY NOT APPLY TO YOU. THIS WRITTEN WARRANTY GIVES YOU SPECIFIC LEGAL RIGHTS. YOU MAY ALSO HAVE OTHER RIGHTS THAT VARY FROM STATE TO STATE.

If You Need Service

Keep your receipt, delivery slip, or some other appropriate payment record to establish the warranty period should service be required. If service is performed, it is in your best interest to obtain and keep all receipts. Service under this warranty must be obtained by contacting Electrolux at the addresses or phone numbers below.

This warranty only applies in the USA and Canada. In the USA, your appliance is warranted by Electrolux Major Appliances North America, a division of Electrolux Home Products, Inc. In Canada, your appliance is warranted by Electrolux Canada Corp. Electrolux authorizes no person to change or add to any obligations under this warranty. Obligations for service and parts under this warranty must be performed by Electrolux or an authorized service company. Product features or specifications as described or illustrated are subject to change without notice.

USA**1-877-435-3827**

Electrolux Major Appliances NA
10200 David Taylor Drive
Charlotte, NC 28262
ElectroluxAppliances.com

**Canada****1.800.265.8352**

Electrolux Canada Corp.
5855 Terry Fox Way
Mississauga, Ontario, Canada
L5V 3E4
ElectroluxAppliances.ca

