

# 24 cu. ft. 3-Door French Door Refrigerator

# SAMSUNG

## MODEL RF24BB6900 DIMENSIONS

### Be sure your new fridge will fit

Don't wait until delivery to be sure your new refrigerator will fit – both in your kitchen and through all doorways. This guide includes all pertinent measurements and clearances so you can buy with confidence.

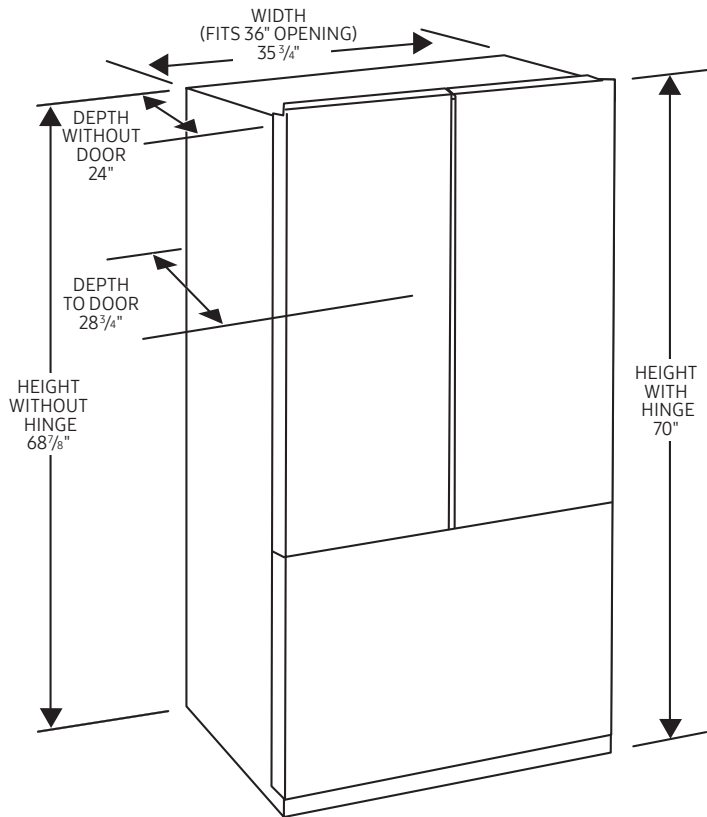

TOP OF REFRIGERATOR WITH DRAWER OPEN

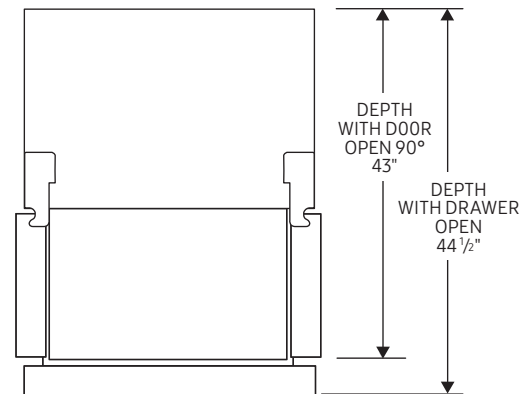

TOP OF REFRIGERATOR WITH DOORS OPEN 125°

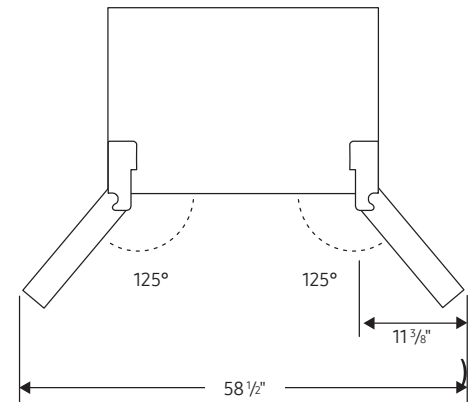

### Counter-Depth Refrigerator

Counter-depth models sit flush with your kitchen cabinets for a premium, built-in look. They are perfect for galley and island kitchens where space is limited.

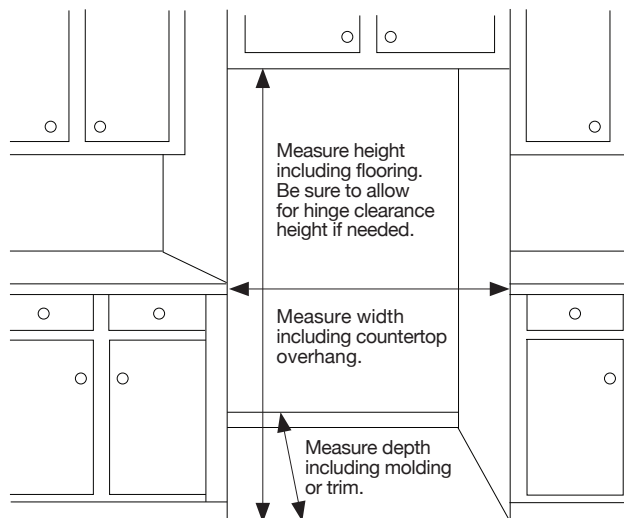

### Installation clearances

- ✓ Allow  $3\frac{3}{4}"$  of clearance when installing along a wall. This will allow for the door to open 90 degrees without the handle contacting the wall.
- ✓ Allow 2" minimum clearance at rear for proper air circulation and water/electrical connections.
- ✓ Allow a  $\frac{3}{8}"$  minimum clearance at sides and top for ease of installation.

**For optimal usage and ability to open refrigerator doors completely, do not install next to a wall.**

*Please note: The above dimension and cutout information is for planning purposes only. For complete installation details, consult manual packed with product or download manual online at [samsung.com](http://samsung.com).*

### Walk the delivery route

- ✓ Identify the narrowest opening that the appliance will travel through, from outside the home to the location where it will be installed.
- ✓ Appliance depth or width must be smaller than the width of the narrowest opening.