

SAMSUNG

Product Guide

Bespoke Customizable Door Panels

3-Door French Door



Product Overview

Product Title*

Bespoke 3-Door French Door Refrigerator Panel in White Glass - Top Panel

*Product title should be updated upon color setup.

Product Description

Personalize your Bespoke 3-Door French Door Refrigerator with customizable and changeable refrigerator door panels. Choose from a range of colors and either steel or glass finishes, to design a refrigerator that expresses your personal style. If you want to update your décor, you can simply change the color of your refrigerator by choosing new panels.

Available Colors

Color	Model #	Product Title	UPC Code
	RA-F18DU3QL	Bespoke 3-Door French Door Refrigerator Panel in Stainless Steel - Top Panel	887276628721
	RA-F18DU3DT	Bespoke 3-Door French Door Refrigerator Panel in Tuscan Steel - Top Panel	887276661094
	RA-F18DU333	Bespoke 3-Door French Door Refrigerator Panel in Charcoal Glass - Top Panel	887276628691
	RA-F18DU3MT	Bespoke 3-Door French Door Refrigerator Panel in Matte Black Steel - Top Panel	887276628523
	RA-F18DU331	Bespoke 3-Door French Door Refrigerator Panel in Matte Grey Glass - Top Panel	887276628684
	RA-F18DU312	Bespoke 3-Door French Door Refrigerator Panel in White Glass - Top Panel	887276628677
	RA-F18DU3QN	Bespoke 3-Door French Door Refrigerator Panel in Navy Steel - Top Panel	887276628530
	RA-F18DU3P0	Bespoke 3-Door French Door Refrigerator Panel in Pink Glass - Top Panel	887276628707
	RA-F18DU3QG	Bespoke 3-Door French Door Refrigerator Panel in Emerald Green Steel - Top Panel	887276628714
	RA-F18DU3CM	Bespoke 3-Door French Door Refrigerator Panel in Morning Blue Glass - Top Panel	887276629490
	RA-F18DU3CH	Bespoke 3-Door French Door Refrigerator Panel in Clementine Glass - Top Panel	887276629483
	RA-F18DU3C0	Bespoke 3-Door French Door Refrigerator Panel in Sunrise Yellow Glass - Top Panel	887276648026

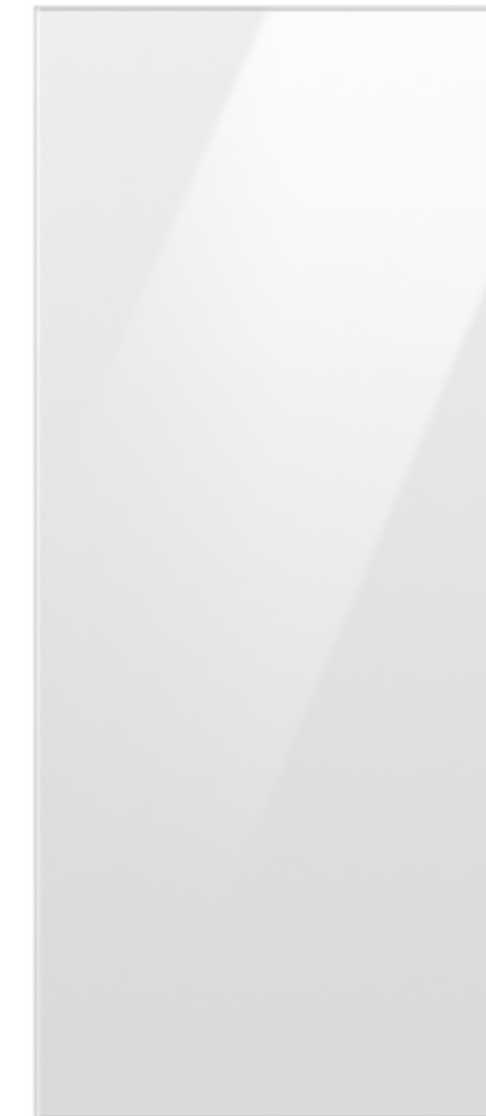

Product Overview

Product Title*

Bespoke 3-Door French Door Refrigerator Panel in White Glass - Bottom Panel

*Product title should be updated upon color setup.

Product Description

Personalize your Bespoke 3-Door French Door Refrigerator with customizable and changeable freezer door panels. Choose from a range of colors and either steel or glass finishes, to design a refrigerator that expresses your personal style. If you want to update your décor, you can simply change the color of your refrigerator by choosing new panels.

Available Colors

Color	Model #	Product Title	UPC Code
Stainless Steel	RA-F36DB3QL	Bespoke 3-Door French Door Refrigerator Panel in Stainless Steel - Bottom Panel	887276628820
Tuscan Steel	RA-F36DB3DT	Bespoke 3-Door French Door Refrigerator Panel in Tuscan Steel - Bottom Panel	887276661094
Charcoal Glass	RA-F36DB333	Bespoke 3-Door French Door Refrigerator Panel in Charcoal Glass - Bottom Panel	887276628783
Matte Black Steel	RA-F36DB3MT	Bespoke 3-Door French Door Refrigerator Panel in Matte Black Steel - Bottom Panel	887276628790
Matte Grey Glass	RA-F36DB331	Bespoke 3-Door French Door Refrigerator Panel in Matte Grey Glass - Bottom Panel	887276628776
White Glass	RA-F36DB312	Bespoke 3-Door French Door Refrigerator Panel in White Glass - Bottom Panel	887276628769
Navy Steel	RA-F36DB3QN	Bespoke 3-Door French Door Refrigerator Panel in Navy Steel - Bottom Panel	887276628837
Pink Glass	RA-F36DB3P0	Bespoke 3-Door French Door Refrigerator Panel in Pink Glass - Bottom Panel	887276628806
Emerald Green Steel	RA-F36DB3QG	Bespoke 3-Door French Door Refrigerator Panel in Emerald Green Steel - Bottom Panel	887276628813
Morning Blue Glass	RA-F36DB3CM	Bespoke 3-Door French Door Refrigerator Panel in Morning Blue Glass - Bottom Panel	887276629537
Clementine Glass	RA-F36DB3CH	Bespoke 3-Door French Door Refrigerator Panel in Clementine Glass - Bottom Panel	887276629520
Sunrise Yellow Glass	RA-F36DB3C0	Bespoke 3-Door French Door Refrigerator Panel in Sunrise Yellow Glass - Bottom Panel	887276648125



Carousel Image Order - Top Panels



Carousel Image Order - Bottom Panels



Carousel Images - Easy Ads Links

Top Panels R.COM

<https://dam.gettyimages.com/p/z0c3461/external?o=AND&q=RA-F18DU312%20RCOM>
<https://dam.gettyimages.com/p/z0c3461/external?o=AND&q=RA-F18DU3QL%20RCOM>
<https://dam.gettyimages.com/p/z0c3461/external?o=AND&q=RA-F18DU331%20RCOM>
<https://dam.gettyimages.com/p/z0c3461/external?o=AND&q=RA-F18DU3MT%20RCOM>
<https://dam.gettyimages.com/p/z0c3461/external?o=AND&q=RA-F18DU333%20RCOM>
<https://dam.gettyimages.com/p/z0c3461/external?o=AND&q=RA-F18DU3QN%20RCOM>
<https://dam.gettyimages.com/p/z0c3461/external?o=AND&q=RA-F18DU3QG%20RCOM>
<https://dam.gettyimages.com/p/z0c3461/external?o=AND&q=RA-F18DU3DT%20RCOM>
<https://dam.gettyimages.com/p/z0c3461/external?o=AND&q=RA-F18DU3CM%20RCOM>
<https://dam.gettyimages.com/p/z0c3461/external?o=AND&q=RA-F18DU3CH%20RCOM>
<https://dam.gettyimages.com/p/z0c3461/external?o=AND&q=RA-F18DU3C0%20RCOM>
<https://dam.gettyimages.com/p/z0c3461/external?o=AND&q=RA-F18DU3P0%20RCOM>

Top Panels S.COM

<https://dam.gettyimages.com/p/z0c3461/external?o=AND&q=RA-F18DU312%20SCOM>
<https://dam.gettyimages.com/p/z0c3461/external?o=AND&q=RA-F18DU3QL%20SCOM>
<https://dam.gettyimages.com/p/z0c3461/external?o=AND&q=RA-F18DU331%20SCOM>
<https://dam.gettyimages.com/p/z0c3461/external?o=AND&q=RA-F18DU3MT%20SCOM>
<https://dam.gettyimages.com/p/z0c3461/external?o=AND&q=RA-F18DU333%20SCOM>
<https://dam.gettyimages.com/p/z0c3461/external?o=AND&q=RA-F18DU3QN%20SCOM>
<https://dam.gettyimages.com/p/z0c3461/external?o=AND&q=RA-F18DU3QG%20SCOM>
<https://dam.gettyimages.com/p/z0c3461/external?o=AND&q=RA-F18DU3DT%20SCOM>
<https://dam.gettyimages.com/p/z0c3461/external?o=AND&q=RA-F18DU3CM%20SCOM>
<https://dam.gettyimages.com/p/z0c3461/external?o=AND&q=RA-F18DU3CH%20SCOM>
<https://dam.gettyimages.com/p/z0c3461/external?o=AND&q=RA-F18DU3C0%20SCOM>
<https://dam.gettyimages.com/p/z0c3461/external?o=AND&q=RA-F18DU3P0%20SCOM>

Bottom Panels R.COM

<https://dam.gettyimages.com/p/z0c3461/external?o=AND&q=RA-F36DB312%20RCOM>
<https://dam.gettyimages.com/p/z0c3461/external?o=AND&q=RA-F36DB3QL%20RCOM>
<https://dam.gettyimages.com/p/z0c3461/external?o=AND&q=RA-F36DB331%20RCOM>
<https://dam.gettyimages.com/p/z0c3461/external?o=AND&q=RA-F36DB3MT%20RCOM>
<https://dam.gettyimages.com/p/z0c3461/external?o=AND&q=RA-F36DB333%20RCOM>
<https://dam.gettyimages.com/p/z0c3461/external?o=AND&q=RA-F36DB3QN%20RCOM>
<https://dam.gettyimages.com/p/z0c3461/external?o=AND&q=RA-F36DB3QG%20RCOM>
<https://dam.gettyimages.com/p/z0c3461/external?o=AND&q=RA-F36DB3DT%20RCOM>
<https://dam.gettyimages.com/p/z0c3461/external?o=AND&q=RA-F36DB3CM%20RCOM>
<https://dam.gettyimages.com/p/z0c3461/external?o=AND&q=RA-F36DB3CH%20RCOM>
<https://dam.gettyimages.com/p/z0c3461/external?o=AND&q=RA-F36DB3C0%20RCOM>
<https://dam.gettyimages.com/p/z0c3461/external?o=AND&q=RA-F36DB3P0%20RCOM>

Bottom Panels S.COM

<https://dam.gettyimages.com/p/z0c3461/external?o=AND&q=RA-F36DB312%20SCOM>
<https://dam.gettyimages.com/p/z0c3461/external?o=AND&q=RA-F36DB3QL%20SCOM>
<https://dam.gettyimages.com/p/z0c3461/external?o=AND&q=RA-F36DB331%20SCOM>
<https://dam.gettyimages.com/p/z0c3461/external?o=AND&q=RA-F36DB3MT%20SCOM>
<https://dam.gettyimages.com/p/z0c3461/external?o=AND&q=RA-F36DB333%20SCOM>
<https://dam.gettyimages.com/p/z0c3461/external?o=AND&q=RA-F36DB3QN%20SCOM>
<https://dam.gettyimages.com/p/z0c3461/external?o=AND&q=RA-F36DB3QG%20SCOM>
<https://dam.gettyimages.com/p/z0c3461/external?o=AND&q=RA-F36DB3DT%20SCOM>
<https://dam.gettyimages.com/p/z0c3461/external?o=AND&q=RA-F36DB3CM%20SCOM>
<https://dam.gettyimages.com/p/z0c3461/external?o=AND&q=RA-F36DB3CH%20SCOM>
<https://dam.gettyimages.com/p/z0c3461/external?o=AND&q=RA-F36DB3C0%20SCOM>
<https://dam.gettyimages.com/p/z0c3461/external?o=AND&q=RA-F36DB3P0%20SCOM>

Feature and Benefit – Bespoke Customizable Door Panels

Overall Product Headline	Feature Name	Long Body Copy	Short Body Copy	Associated Image
<p>Customizable Door Colors</p>	<p>Color Customization</p>	<ul style="list-style-type: none"> • Customize the design of your refrigerator with changeable door panels. • Choose from a variety of colors and two finishes to create a space that fits your style. 	<p>With customizable door panels, choose from twelve colors and two finishes to create a space that fits your style.</p>	

Spec Sheets

Easy Ads link

<https://dam.gettyimages.com/p/z0c3461/external?o=AND&q=RA-F18DU3%20Spec%20Sheet>

<https://dam.gettyimages.com/p/z0c3461/external?o=AND&q=RA-F36DB3%20Spec%20Sheet>

RA-F18DU3

Bespoke 3-Door French Door Refrigerator Panel - Top Panel

SAMSUNG



Steel Panel



Glass Panel

Design a refrigerator that's uniquely you.
 Personalize your Bespoke 3-Door French Door Refrigerator with customizable and changeable refrigerator door panels. Choose from a range of colors and either steel or glass finishes, to design a refrigerator that expresses your personal style. If you want to update your décor, you can simply change the color of your refrigerator by choosing new panels.

Bespoke Panel Color Selection



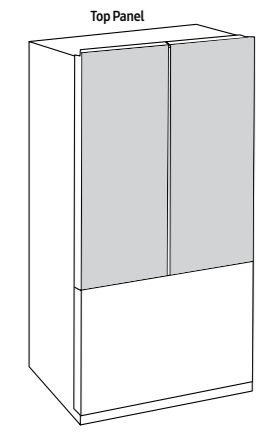

Top Panel

Product Dimensions & Weight (WxHxD)
 Dimensions: 17¹/₈" x 42¹/₈" x 1¹/₈"
 Steel Panel Weight: 6.27 lbs
 Glass Panel Weight: 9.97 lbs

Shipping Dimensions & Weight (WxHxD)
 Dimensions: 21¹/₈" x 45¹/₈" x 1¹/₈"
 Steel Panel Weight: 8.47 lbs
 Glass Panel Weight: 12.17 lbs

Color	Model #	UPC Code
Stainless Steel	RA-F18DU3QL	887276628721
Tuscan Steel	RA-F18DU3DT	887276661094
Charcoal Glass	RA-F18DU333	887276628691
Matte Black Steel	RA-F18DU3MT	887276628523
Matte Grey Glass	RA-F18DU331	887276628684
White Glass	RA-F18DU312	887276628677
Navy Steel	RA-F18DU3QN	887276628530
Pink Glass	RA-F18DU3PO	887276628707
Emerald Green Steel	RA-F18DU3QG	887276628714
Morning Blue Glass	RA-F18DU3CM	887276629490
Clementine Glass	RA-F18DU3CH	887276629483
Sunrise Yellow Glass	RA-F18DU3CO	887276648026

Actual color may vary. Design, specifications, and color availability are subject to change without notice. Non-metric weights and measurements are approximate.
 ©2022 Samsung Electronics America, Inc. 85 Challenger Road, Ridgefield Park, NJ 07660. Tel: 800-SAMSUNG. samsung.com. Samsung is a registered trademark of Samsung Electronics Co., Ltd.

Bespoke Customizable Refrigerator Panel - Top Panel

RA-F36DB3

Bespoke 3-Door French Door Refrigerator Panel - Bottom Panel

SAMSUNG



Steel Panel

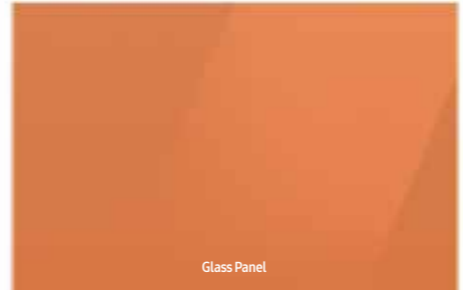

Glass Panel

Design a refrigerator that's uniquely you.
 Personalize your Bespoke 3-Door French Door Refrigerator with customizable and changeable freezer door panels. Choose from a range of colors and either steel or glass finishes, to design a refrigerator that expresses your personal style. If you want to update your décor, you can simply change the color of your refrigerator by choosing new panels.

Bespoke Panel Color Selection



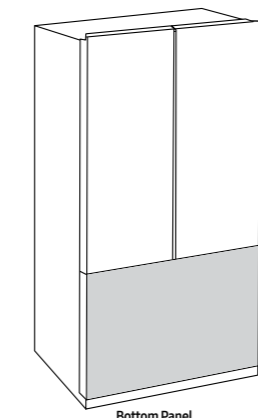

Bottom Panel

Product Dimensions & Weight (WxHxD)
 Dimensions: 35¹/₈" x 23¹/₂" x 1¹/₈"
 Steel Panel Weight: 5.35 lbs
 Glass Panel Weight: 8.16 lbs

Shipping Dimensions & Weight (WxHxD)
 Dimensions: 39¹/₈" x 26¹/₈" x 2¹/₈"
 Steel Panel Weight: 7.82 lbs
 Glass Panel Weight: 10.63 lbs

Color	Model #	UPC Code
Stainless Steel	RA-F36DB3QL	887276628820
Tuscan Steel	RA-F36DB3DT	887276661117
Charcoal Glass	RA-F36DB333	887276628783
Matte Black Steel	RA-F36DB3MT	887276628790
Matte Grey Glass	RA-F36DB331	887276628776
White Glass	RA-F36DB312	887276628769
Navy Steel	RA-F36DB3QN	887276628837
Pink Glass	RA-F36DB3PO	887276628806
Emerald Green Steel	RA-F36DB3QG	887276628813
Morning Blue Glass	RA-F36DB3CM	887276629537
Clementine Glass	RA-F36DB3CH	887276629520
Sunrise Yellow Glass	RA-F36DB3CO	887276648125

Actual color may vary. Design, specifications, and color availability are subject to change without notice. Non-metric weights and measurements are approximate.
 ©2022 Samsung Electronics America, Inc. 85 Challenger Road, Ridgefield Park, NJ 07660. Tel: 800-SAMSUNG. samsung.com. Samsung is a registered trademark of Samsung Electronics Co., Ltd.

Bespoke Customizable Refrigerator Panel - Bottom Panel

Bespoke Panel Installation Videos

Easy Ads link

<https://dam.gettyimages.com/p/z0c3461/external?o=AND&q=Bespoke%20Videos>



Bespoke 3-Door Panel Installation - Text



Bespoke 3-Door Panel Installation - No Text

Bespoke Panel Installation Guide

Easy Ads link

<https://dam.gettyimages.com/p/z0c3461/external?o=AND&q=RF29BB8900%20Installation%20Guide>

Installation Instruction

DA68-02659F-01 

EN Depending on the product type, the number of clips may differ but the installation guide applies the same.

MES Dependiendo del tipo de producto, la cantidad de grapas puede diferir, pero la guía de instalación aún aplica.

CFR En fonction du type de produit, le nombre de brides peut varier mais le guide d'installation reste le même.

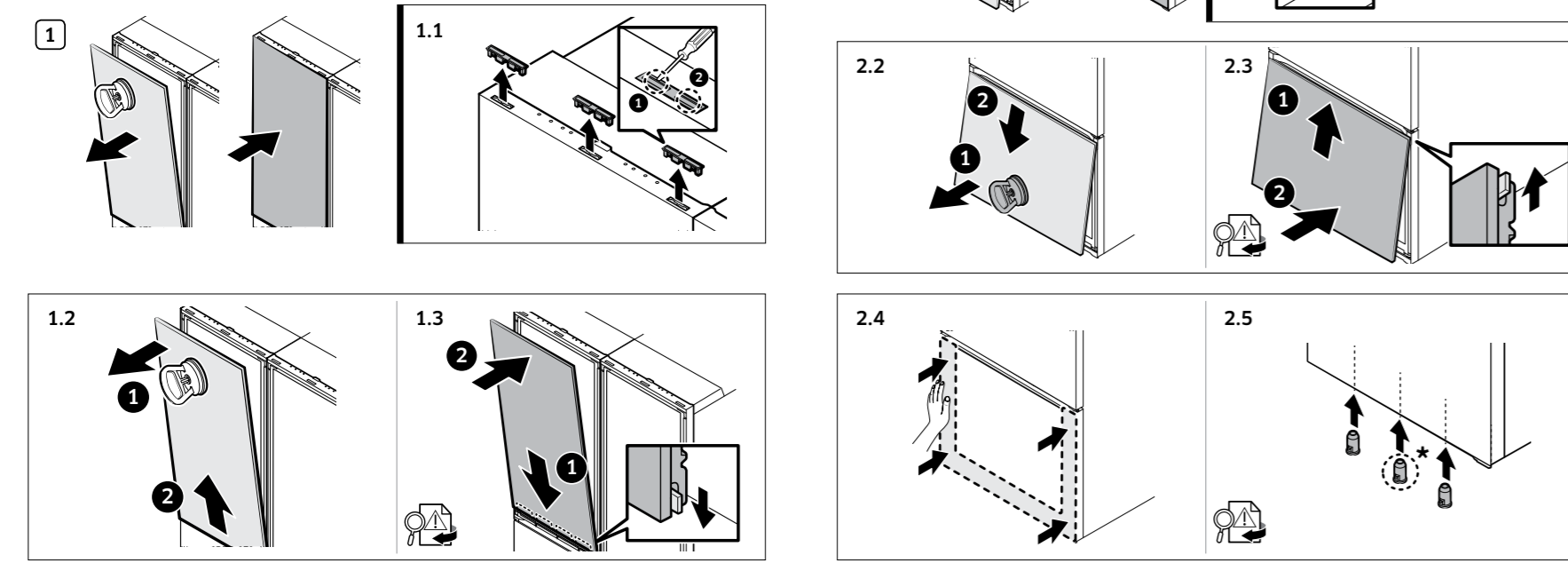
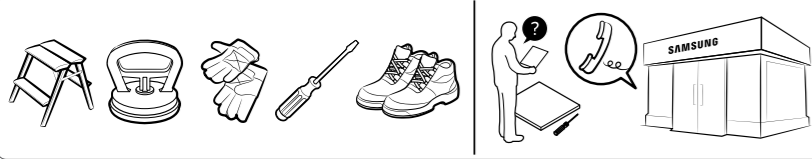

Installation Instruction

⚠ CAUTION EN

- Place the top panel into the groove along the bottom of the top door and press the edges of the panel in to secure it as shown in figure 1.3. Make sure that there is no gap between the panel and the door. Once the panel is securely installed, insert the retaining clips as shown in figure 1.5.
- Place the middle or bottom panel into the groove along the top of the bottom door and press the edges of the panel in to secure it as shown in figure 2.3. Make sure that there is no gap between the panel and the door. Once the panel is securely installed, insert the retaining clips as shown in figure 2.5. (The number of clips differs with the product type.)
- After inserting the panel properly, make sure it is firmly secured by pressing its edges tightly.
- Ensure there is no gap between the panel and the door and the retaining clips are fully inserted to prevent the panel from falling off due to external forces.
- Wear gloves without ornaments such as rings before working on the installation.
 - It is recommended to use a chair or ladder when working on a higher portion of the product. Be careful not to fall.
 - For safety reasons, two or more persons are recommended to handle the product.
 - When removing the bottom clips, take caution not to drop them under the bottom of the product.

⚠ PRECAUCIÓN MES

- Inserte el panel superior en el canal de abajo de la puerta superior y presione los bordes del panel para ensamblarlo como se muestra en la figura 1.3. Verifique que no haya espacio entre el panel y la puerta en ningún punto alrededor del marco y después fíjelo insertando los clips como se muestra en la figura 1.5.
- Coloque el panel central o inferior en la ranura a lo largo de la parte superior de la puerta inferior y presione los bordes del panel para asegurarlo como se muestra en la figura 2.3. Asegúrese de que no quede espacio entre el panel y la puerta. Una vez que el panel quede instalado en forma segura, inserte las grapas de retención como se muestra en la figura 2.5. (La cantidad de grapas varía según el tipo de producto).
- Luego de colocar el panel adecuadamente, asegúrese de que quede bien agarrado presionando sus bordes con firmeza.
- Si los clips no se insertan completamente o hay un espacio entre el panel y la puerta, el panel puede caerse con cualquier impacto externo, como golpes o cerrando fuerte la puerta.
- Use guantes sin accesorios tales como anillos antes de trabajar en la instalación.
 - Se recomienda el uso de una silla o una escalera al trabajar en la parte superior del producto. Tenga cuidado de no caerse.
 - Por razones de seguridad, se recomienda que el producto sea manipulado por dos o más personas.
 - Al quitar las grapas de la parte inferior, tenga cuidado de que no se caigan debajo del producto.

⚠ ATTENTION CFR

- Insérez le panneau supérieur dans la rainure de fixation de la partie inférieure de la porte supérieure, puis appuyez sur le bord du panneau pour le fixer comme indiqué à la figure 1.3, et vérifiez qu'il n'y a pas d'espace entre le panneau et la porte, puis fixez-le en insérant les clips comme illustré à la figure 1.5.
- Placez le panneau central ou inférieur dans la rainure le long de la partie supérieure de la porte inférieure et appuyez sur les bords du panneau pour le fixer comme indiqué sur la figure 2.3. Vérifiez l'absence d'espace entre le panneau et la porte. Une fois le panneau correctement installé, insérez les brides de retenue comme indiqué sur la figure 2.5. (Le nombre de brides varie en fonction du type de produit.)
- Une fois le panneau inséré correctement, appuyez fermement sur ses bords pour vous assurer de sa fixation adéquate.
- Si les clips ne sont pas complètement insérés ou s'il y a un espace entre le panneau et la porte, le panneau peut tomber à la suite d'un choc externe.
- Portez des gants sans bijoux, telles que des bagues, lorsque vous procédez à l'installation.
 - Il est recommandé d'utiliser une chaise ou une échelle lorsque vous intervenez sur une partie en hauteur de l'appareil. Faites attention à ne pas tomber.
 - Pour des raisons de sécurité, deux personnes ou plus sont recommandées pour manipuler l'appareil.
 - Lors du retrait des brides inférieures, veillez à ne pas les faire tomber sous l'appareil.

SAMSUNG