

1000 CFM Inline Blower
VT12FZ

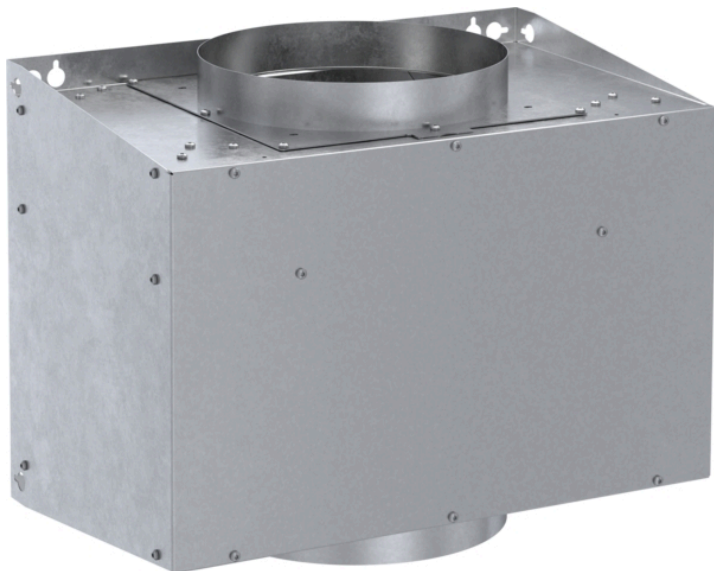

Product Features



Notes: Please refer to installation instructions. Installation instructions are available at www.thermador.com. Specifications are correct at the time of printing. Thermador reserves the right to change product specifications and design at any time, without notice.

1 800 735 4328 | WWW.THERMADOR.COM | 1901 Main Street, Suite 600 Irvine, CA 92614

©2022 BSH HOME APPLIANCES CORPORATION, ALL RIGHTS RESERVED LITHO DATE: 05/2022

1000 CFM Inline Blower
VTI2FZ

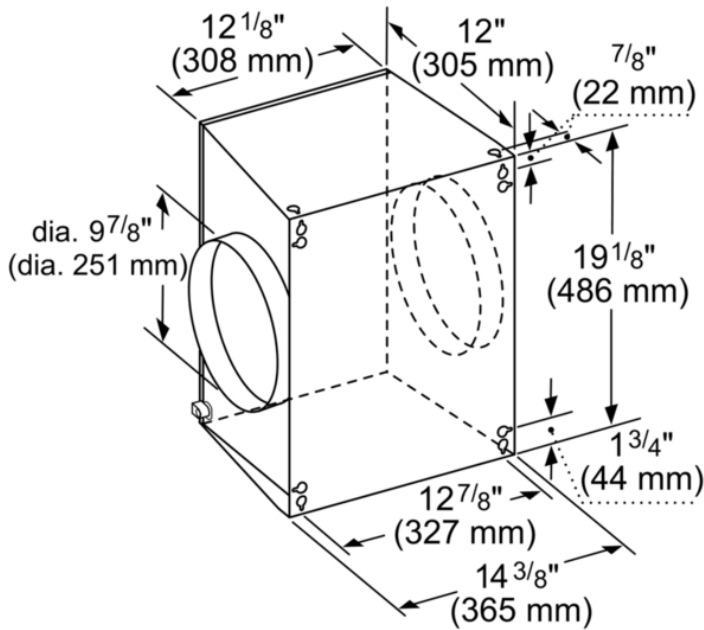

measurements in inches (mm)

Product Features

	Accessory
Brand	Thermador
SKU	VTI2FZ
Internal article number	VTI2FZ
EAN code	825225964865
Product packaging dimensions (HxWxD)	18" x 24" x 27"
	31
	34
UPC code	825225964865
Product image	19805469_VTI2FZ_Front_Facing_3000_x_3000_c

Technical Specification

Notes: Please refer to installation instructions. Installation instructions are available at www.thermador.com. Specifications are correct at the time of printing. Thermador reserves the right to change product specifications and design at any time, without notice.

1 800 735 4328 | WWW.THERMADOR.COM | 1901 Main Street, Suite 600 Irvine, CA 92614

©2022 BSH HOME APPLIANCES CORPORATION, ALL RIGHTS RESERVED LITHO DATE: 05/2022