

SANUS

WSEDM2

Mount
for Amazon Echo Dot (4th Gen)

INSTRUCTION MANUAL

ES FR DE NL SV RU ZH JA

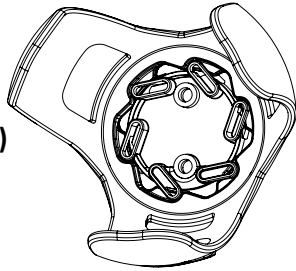

We're here to help!



Our install experts are standing by to help.



Call us at:

US: 1-800-359-5520 • UK: 0800 056 2853
EMEA: +31 (0) 495 580 852

www.SANUS.com

6901-602685 00

Parts & Hardware



Speaker Holder
01 qty. 1



Base
02 qty. 1

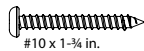

#10 x 1-3/4 in.
Wall Plate Screw
03 qty. 2

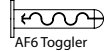

AF6 Toggle
Anchor
04 qty. 2



3M Command™
Strip
05 qty. 2

Tools Needed

(not needed for 3M Command™ Strip install)



Pencil



Level



Phillips
Screwdriver



Electric
Drill

Drywall Install



Hammer



1/4 in.
(6 mm)
Drill Bit

Wood Stud Install



Stud Finder



1/8 in.
(3 mm)
Wood
Drill Bit

1 SECURE THE BASE

Drywall Only Installation

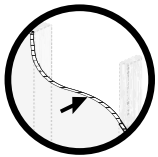

**Drywall
Option**

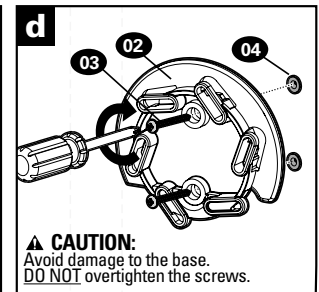
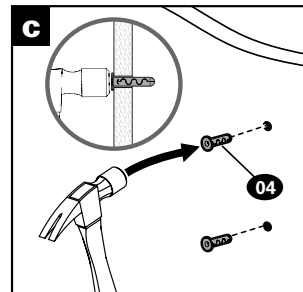
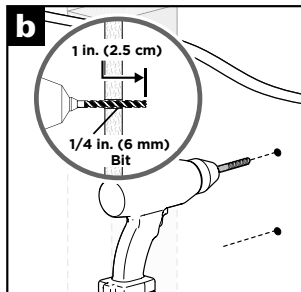
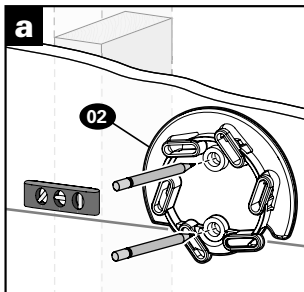

CAUTION:
Avoid damage to the base.
DO NOT overtighten the screws.

Wood Stud Installation

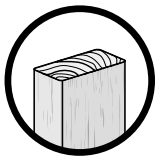

**Wood Stud
Option**

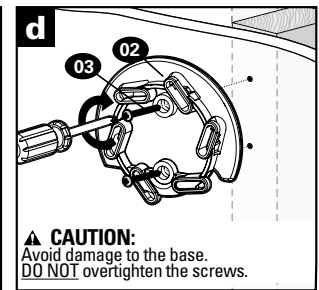
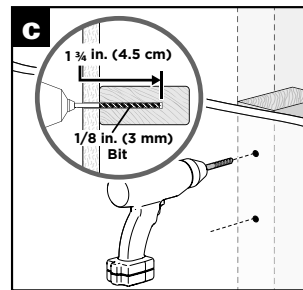
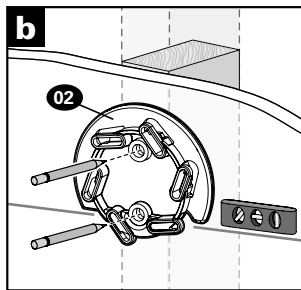
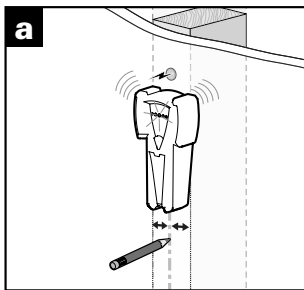

CAUTION:
Avoid damage to the base.
DO NOT overtighten the screws.

Command™ Strip Installation



**No Drill
Option**

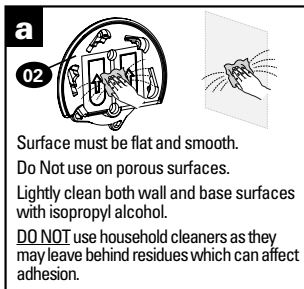

Surface must be flat and smooth.
Do Not use on porous surfaces.
Lightly clean both wall and base surfaces
with isopropyl alcohol.
DO NOT use household cleaners as they
may leave behind residues which can affect
adhesion.

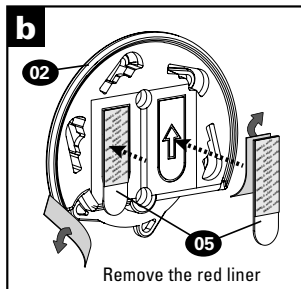

Remove the red liner

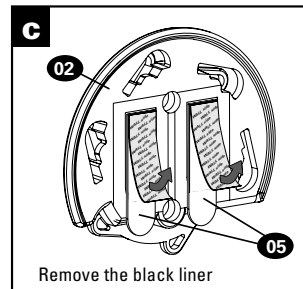

Remove the black liner

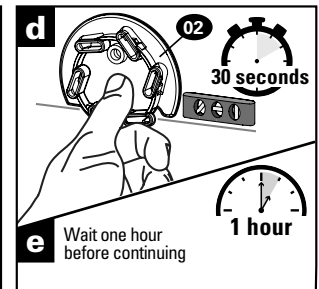

30 seconds

Wait one hour
before continuing

1 hour



Questions?

Call us at:

US: 1-800-359-5520 • UK: 0800 056 2853 • EMEA: +31 (0) 495 580 852

www.SANUS.com

2 INSTALL SPEAKER

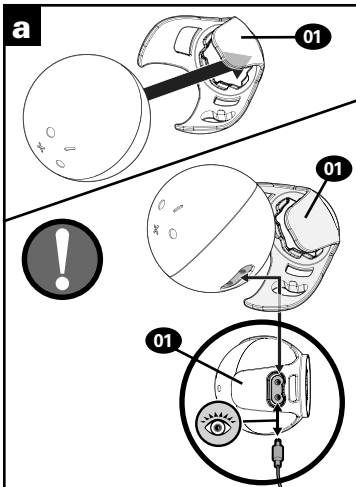

3 ATTACH TO BASE

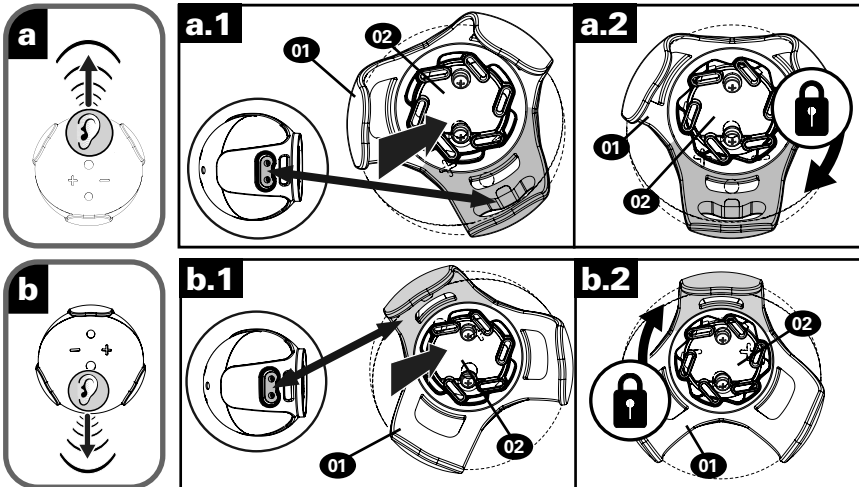

4 PLUG IN

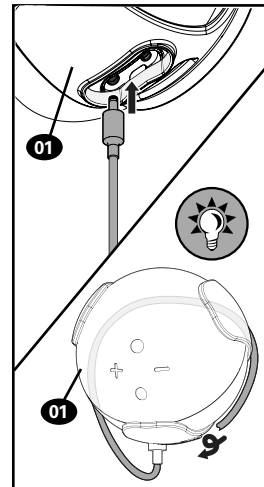

TO REMOVE

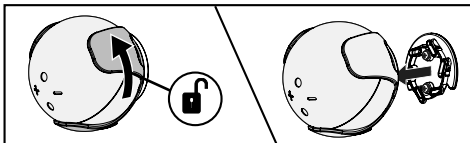

DO NOT pull the 3M Command™ strip AWAY from the wall.

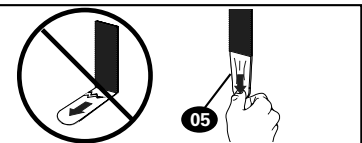

ES ¿QUE HAY EN LA CAJA?

Prepare sus herramientas (no es necesario para instalar la tira 3M Command™)

1 FIJAR LA BASE

- para pared de yeso
- PRECAUCIÓN: No ajuste los tornillos en exceso.
- para montante de madera
- PRECAUCIÓN: No ajuste los tornillos en exceso.
- opción sin necesidad de taladro

Limpie levemente las superficies de la pared y de la base con alcohol isopropílico. No use los productos de limpieza del hogar porque podrían dejar residuos que afecten a la adhesión.

2 INSTALAR EL ALTAVOZ

3 COLOQUE EN EL SOPORTE

4 ENCHUFAR EL CABLE DE ALIMENTACIÓN

PARA RETIRAR NO RETIRE la tira 3M Command™ de la pared.

FR PIÈCES FOURNIES

Munissez-vous de vos outils (non requis pour l'installation de la bande 3M Command™)

1 FIXEZ LA SOCLE

- pour cloison soche
- ATTENTION : Ne pas trop serrer les vis.
- pour montent en bois
- ATTENTION : Ne pas trop serrer les vis.
- option sans perçage

Nettoyez légèrement les surfaces du mur et de la base avec de l'alcool isopropylrique. N'utilisez pas de nettoyeurs ménagers, car ils pourraient laisser des résidus pouvant avoir une incidence sur l'adhésion.

2 FIXEZ LE HAUT-PARLEUR

3 INSTALLEZ DANS LE SUPPORT

4 BRANCHEMENT DU CORDON D'ALIMENTATION

POUR RETIRER N'arrachez PAS la bande 3M Command™ du mur.

DE LIEFERUMFANG

Sie brauchen (wird nicht für die Installation von 3M Command™-Leisten benötigt)

1 DER BASIS BEFESTIGEN

- für Gipskartonplatte
- VORSICHT: Ziehen Sie die Schrauben nicht zu fest an!
- für Holzbalken
- VORSICHT: Ziehen Sie die Schrauben nicht zu fest an!
- keine Bohrmöglichkeit

Reinigen Sie Wand- und Bodenflächen leicht mit Isopropylalkohol. Verwenden Sie keine Haushaltsreiniger, da diese Rückstände hinterlassen können, die die Haftung beeinträchtigen können.

2 MONTEREN DES LAUTSPRECHERS

3 SETZEN IN DIE HALTERUNG EIN

4 ANSCHLIESSEN DES NETZKABELS

ENTFERNEN Ziehen Sie den 3M Command™-Streifen NICHT von der Wand WEG.

NL WAT ZIT ER IN DE VERPAKKING?

Leg het gereedschap klaar (niet vereist bij de installatie van de 3M Command™-strip)

1 DE BASIS MONTEREN

- voor gipsplaat
- LET OP: Draai de schroeven niet te vast!
- voor houten dragers
- LET OP: Draai de schroeven niet te vast!
- geen boormogelijkheid

Reinig beide muur- en basisoppervlakken licht met isopropylalcohol. Gebruik geen huishoudelijke reinigingsmiddelen, want deze kunnen resten achterlaten die de hechting kunnen beïnvloeden.

2 BEVESTIG LUIDSPREKER

3 PLAATS IN DE MONTAGE

4 VOEDINGSKABEL AANSLUITEN

OM TE VERWIJDEREN Trek de 3M Command™-strip NIET van de muur.

SV VAD FINNS I LÅDAN?

Ta dina verktyg (behövs inte för installation av 3M Command™-remsan)

1 SÄKRA BASEN

- för gipsväg
- FÖRSIKTIGT: Dra inte åt skruvarna för hårt!
- för träreglar
- FÖRSIKTIGT: Dra inte åt skruvarna för hårt!
- alternativ utan borr

Rengör lätt både vägg- och golvtytor med isopropylalkohol. Använd inte hushållsrengöringsmedel eftersom de kan lämna rester som kan påverka vidhäftningsförmågan.

2 MONTERA HÖGTALARE

3 SÖTT FAST I FÖSTET

4 ANSLUTA ELSLADD

TA BORT DRÅ INTE BORT 3M Command™-remsan FRÅN väggen.

RU КОМПЛЕКТ ПОСТАВКИ

Хватайте инструменти и вперед! (не требуются для монтажа крепежной ленты 3M Command™)

1 КРЕПЛЕНИЕ ОСНОВАНИЮ

- Для установки на гипсокартон
- ПРЕДОСТЕРЕЖЕНИЕ! Не затягивайте винты с излишним усилием!
- Для установки на деревянные стойки
- ПРЕДОСТЕРЕЖЕНИЕ! Не затягивайте винты с излишним усилием!
- Сверление не требуется

Слегка протрите стену и поверхности основания изопропиловым спиртом. Не используйте бытовые чистящие средства, поскольку они могут оставлять следы, снижающие адгезию.

2 Прикрепите колонку

3 Вставьте на крепление

4 Подключение шнура питания

СНЯТИЕ НЕ снимайте крепежную ленту 3M Command™ со стены.

ZH 包装箱中的内容

需要准备的工具 (在 3M Command™ 胶条安装中不需要使用)

1 安装安装底座 至您的墙壁

- 对于干墙
- 注意: 请勿过度拧紧螺丝!
- 对于木墙柱
- 注意: 请勿过度拧紧螺丝!
- 无钻孔选项

使用异丙醇轻轻清洁墙面和底座表面。请勿使用家用清洁剂, 因为这类清洁剂可能会留下残留物, 因而影响粘贴效果。

2 安装扬声器

3 安装 到支架上

4 插入电源线

拆卸外罩 请勿将 3M Command™ 胶带从墙面撕离。

JA 同梱品

必要なツール (3M Command™ストリップでの取り付けには不要)

1 マウントベースをウォールに取り付けます

- 石膏ボードの場合
- 注意: ネジを締めすぎないようにしてください。
- 木製スタッドの場合
- 注意: ネジを締めすぎないようにしてください。
- 穴を開けない方法

壁と底面にインソプロピルアルコールで軽く拭きます。成分が残る粘着力に影響を与える可能性があるため、家庭用洗剤は使用しないでください。

2 スピーカーを取り付ける

3 取り付け

4 電源コードを接続する

を外して 3M Command™ストリップを壁から手前に引っ張るようにしてください。

Legrand AV Inc. 6436 City West Parkway; Eden Prairie, MN 55344, USA
US: 1-800-359-5520 • info@SANUS.com
SANUS.com

Legrand AV Netherlands B.V. Franklinstraat 14 6003 DK Weert, Netherlands
UK: 0800-056-2853 • EMEA: +31 (0) 495 580 852 • info@SANUS.com
SANUS.com

Legrand AV Inc. and its affiliated corporations and subsidiaries (collectively, "Legrand"), intend to make this manual accurate and complete. However, Legrand makes no claim that the information contained herein covers all details, conditions, or variations. Nor does it provide for every possible contingency in connection with the installation or use of this product. The information contained in this document is subject to change without notice or obligation of any kind. Legrand makes no representation of warranty, expressed or implied, regarding the information contained herein. Legrand assumes no responsibility for accuracy, completeness or sufficiency of the information contained in this document.

©2020 Legrand AV Inc. All Rights Reserved. SANUS is a Legrand AV Inc. brand and a registered trademark owned by Legrand.

All other brand names or marks are used for identification purposes and are trademarks of their respective owners.

Legrand AV Inc. • 6436 City West Parkway • Eden Prairie, MN 55344 USA

6901-602685 00