



INSTRUCTIONS D'ASSEMBLAGE  
ASSEMBLY INSTRUCTIONS

---

**M**ONARCH  
SPECIALTIES INC.

# I 5604Q

---

LIT -  
QUEEN / TISSUS GRIS

BED -  
QUEEN SIZE / GREY LINEN



POUR DE L'ASSISTANCE OU POUR COMMANDER  
DES PIÈCES CONTACTEZ NOTRE DÉPARTEMENT  
DE SERVICE À LA CLIENTÈLE.

FOR ASSISTANCE OR TO ORDER PARTS  
CONTACT OUR CUSTOMER SERVICE DEPARTMENT

**WWW.MONARCHSERVICE.COM**

**LISTE DES PIÈCES**  
**PARTS LIST**

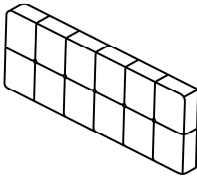
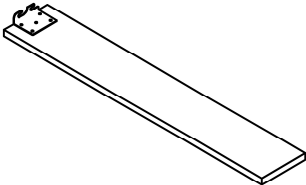
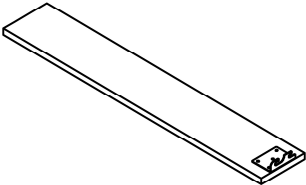
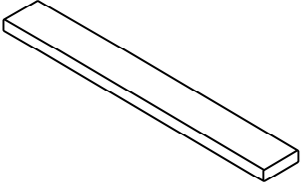
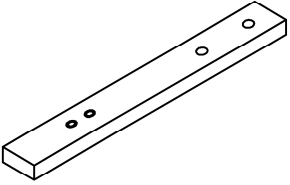
PIÈCE / PART #	IMAGE	DESCRIPTION	QTY / QTÉ
1		HEADBOARD TÊTE DE LIT	1
2		FRONT FACING LEFT SIDE RAIL RAIL DE CÔTÉ GAUCHE	2
3		FRONT FACING RIGHT SIDE RAIL RAIL DE CÔTÉ DROIT	2
4		FOOTBOARD PIED DE LIT	1
5		LEG PATTE	2

**LISTE DES PIÈCES**  
**PARTS LIST**

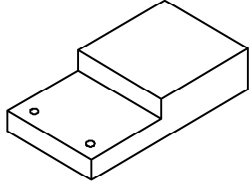
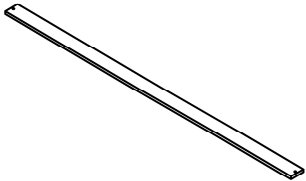
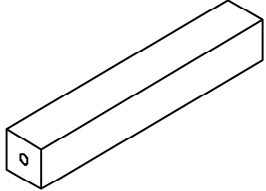
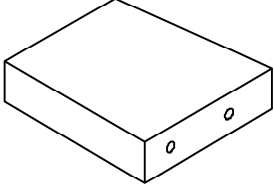
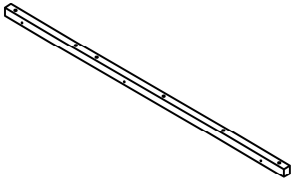
PIÈCE / PART #	IMAGE	DESCRIPTION	QTY / QTÉ
6		<p>SIDE RAIL SUPPORT LEG RAIL DE CÔTÉ PATTE DE SOUTIEN</p>	2
7		<p>SLAT LAMELLE</p>	4
8		<p>SUPPORT LEG PATTE DE SOUTIEN</p>	4
9		<p>WOODEN LEG PATTE EN BOIS</p>	2
10		<p>SUPPORT BAR BARRE DE SOUTIEN</p>	2

**LISTE DES PIÈCES**  
**PARTS LIST**

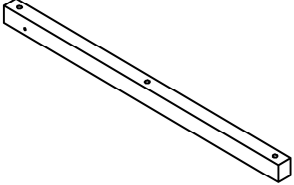
PIÈCE / PART #	IMAGE	DESCRIPTION	QTY / QTÉ
11		SUPPORT BAR BARRE DE SOUTIEN	2

**LISTE DES PIÈCES DE MONTAGE**  
**HARDWARE LIST**

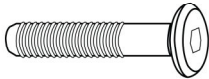
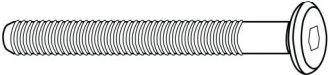
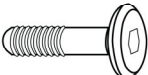
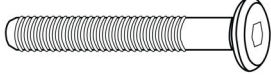
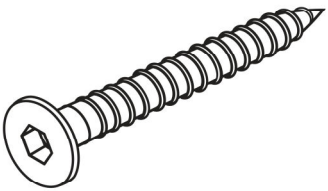
PIÈCE / PART #	IMAGE	DESCRIPTION	QTY / QTÉ
<b>A</b>		ASSEMBLING BOLT - $\text{Ø } 3/8'' \text{ X } 1 \text{ } 3/8''$ BOULON D'ASSEMBLAGE - $\text{Ø } 3/8'' \text{ X } 1 \text{ } 3/8''$	<b>8</b>
<b>B</b>		ASSEMBLING BOLT - $\text{Ø } 3/8'' \text{ X } 4''$ BOULON D'ASSEMBLAGE - $\text{Ø } 3/8'' \text{ X } 4''$	<b>4</b>
<b>C</b>		ASSEMBLING BOLT - $\text{Ø } 3/8'' \text{ X } 3/4''$ BOULON D'ASSEMBLAGE - $\text{Ø } 3/8'' \text{ X } 3/4''$	<b>8</b>
<b>D</b>		ASSEMBLING BOLT - $\text{Ø } 1/4'' \text{ X } 1 \text{ } 3/4''$ BOULON D'ASSEMBLAGE - $\text{Ø } 1/4'' \text{ X } 1 \text{ } 3/4''$	<b>22</b>
<b>E</b>		ASSEMBLING SCREW - $\text{Ø } 1/4'' \text{ X } 1 \text{ } 1/4''$ VIS D'ASSEMBLAGE - $\text{Ø } 1/4'' \text{ X } 1 \text{ } 1/4''$	<b>8</b>

**LISTE DES PIÈCES DE MONTAGE**  
**HARDWARE LIST**

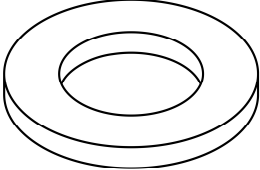
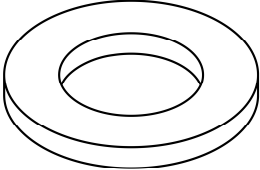
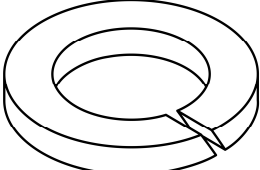
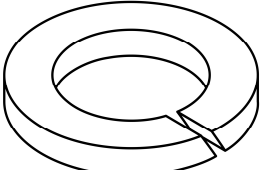
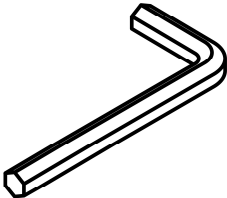
PIÈCE / PART #	IMAGE	DESCRIPTION	QTY / QTÉ
F		METAL WASHER - M8 RONDELLE DE MÉTAL - M8	20
G		METAL WASHER - M6 RONDELLE DE MÉTAL - M6	18
H		LOCK WASHER - M8 ENTRETOISE DE MÉTAL - M8	20
I		LOCK WASHER - M6 ENTRETOISE DE MÉTAL - M6	22
J		HEX KEY - M5 CLÉ HEXAGONALE - M5	1

**LISTE DES PIÈCES DE MONTAGE**  
**HARDWARE LIST**

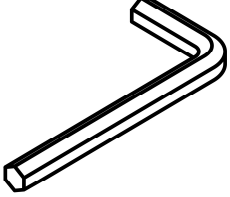
PIÈCE / PART #	IMAGE	DESCRIPTION	QTY / QTÉ
K		HEX KEY - M4 CLÉ HEXAGONALE - M4	1



OUTIL DE VÉRIFICATION DE DIMENSIONS DES PIÈCES  
HARDWARE DIMENSIONS VERIFICATION TOOL





ÉTAPE / STEP 1

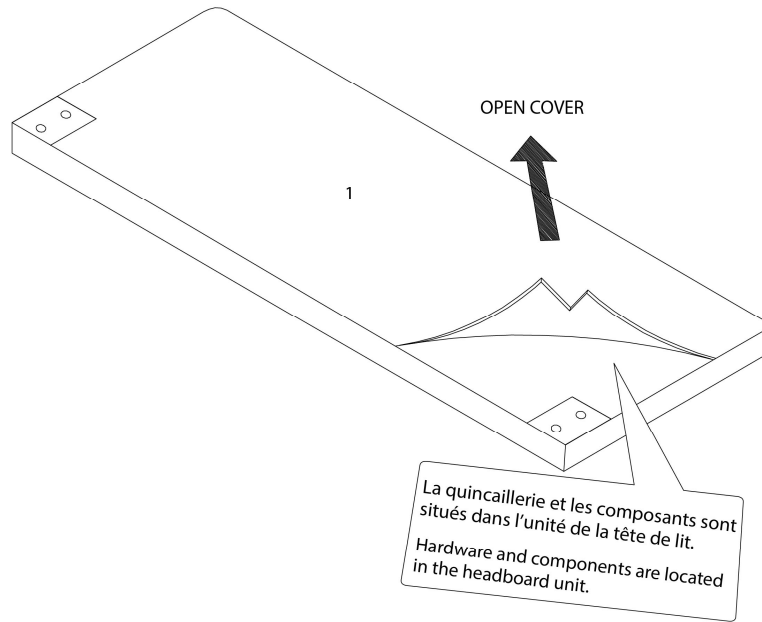

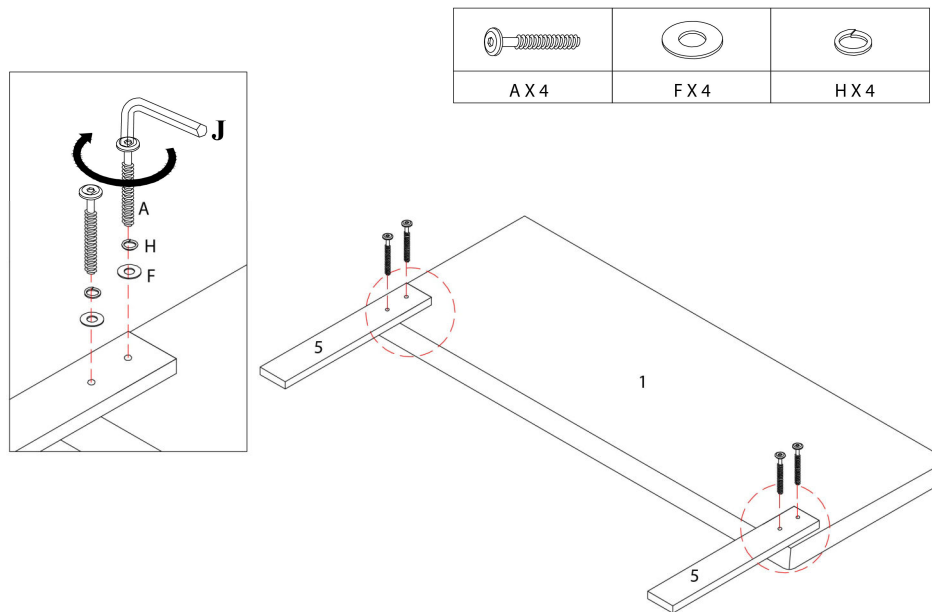

ÉTAPE / STEP 2

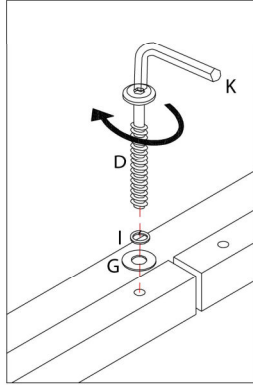

ÉTAPE / STEP 3





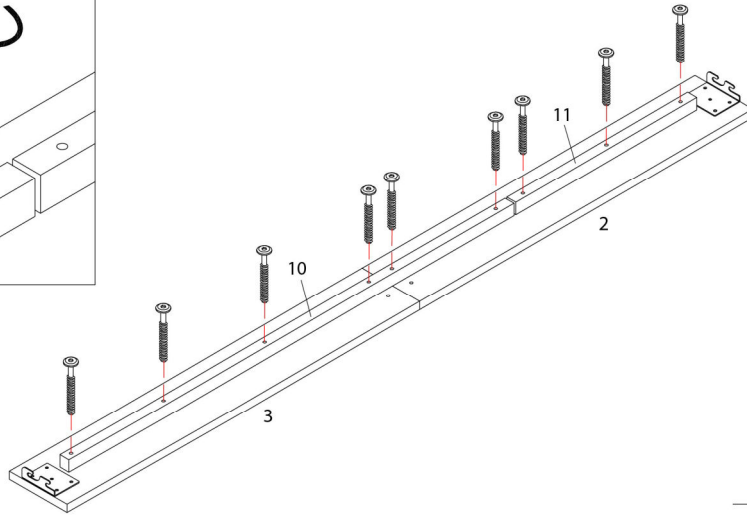

		
DX 18	GX 18	IX 18

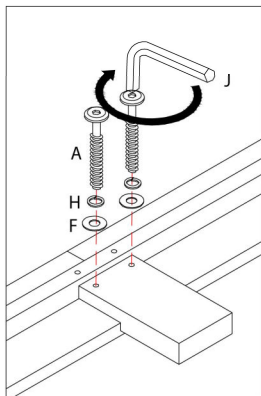

X2

ÉTAPE / STEP 4



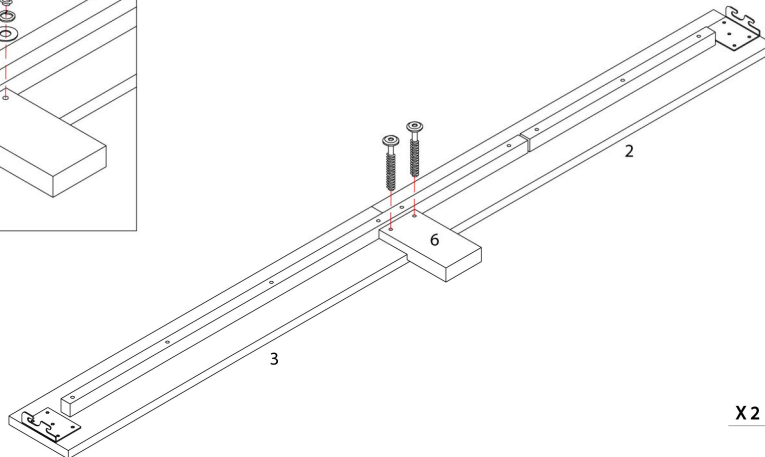

		
AX 4	FX 4	HX 4



X2

ÉTAPE / STEP 5

		
BX 4	FX 4	HX 4

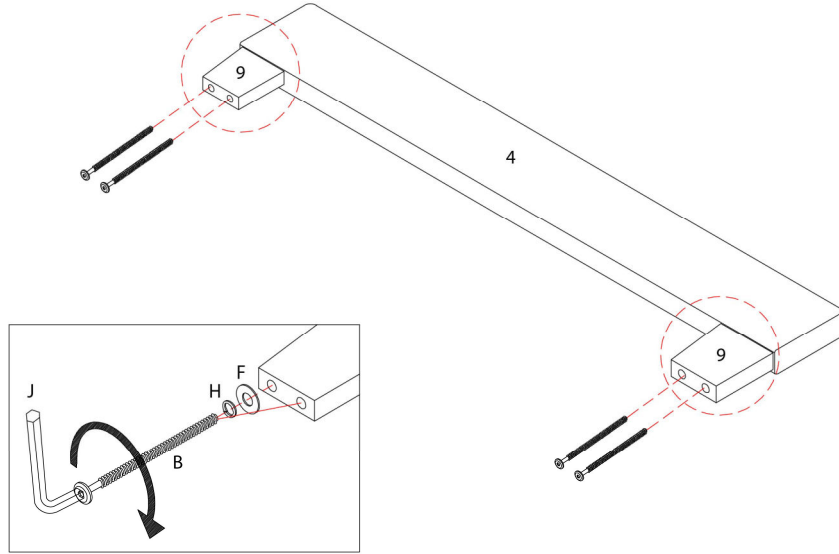

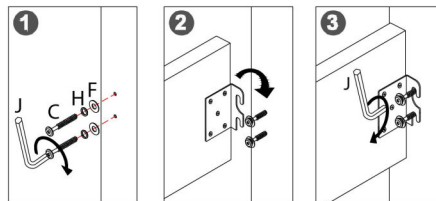
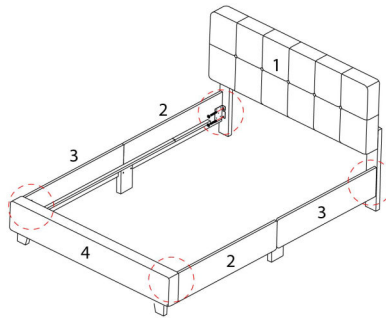

ÉTAPE / STEP 6

		
CX 8	FX 8	HX 8

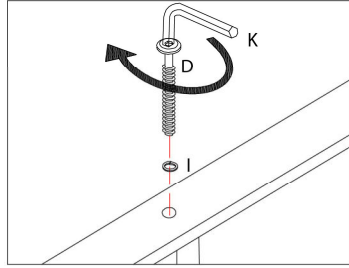

ÉTAPE / STEP 7



	
DX 4	IX 4

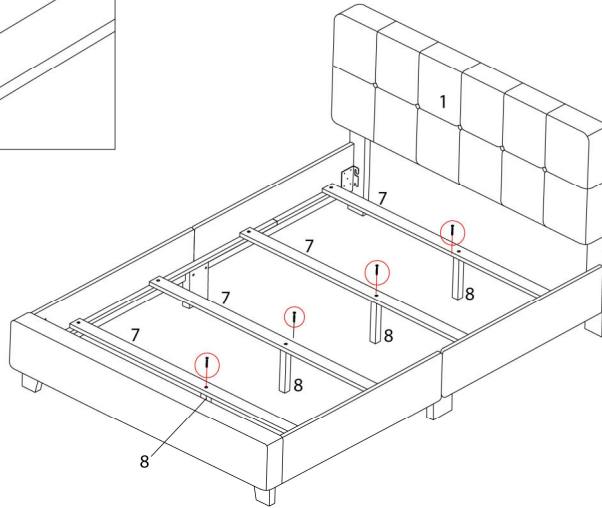

ÉTAPE / STEP 8

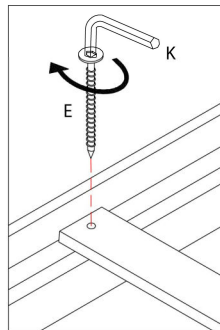

EX 8

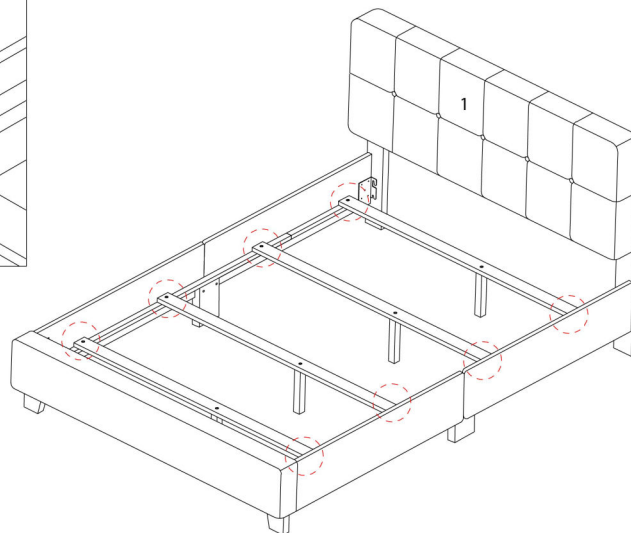

ÉTAPE / STEP 9

