

TRUE RESIDENTIAL[®]

OUTDOOR REFRIGERATION



EVERYTHING OUTDOORS

All True undercounter products are UL-rated for outdoor use and built to withstand the elements, no matter the climate.

REFRIGERATOR



ADA MODELS AVAILABLE

FREEZER



CLEAR ICE MACHINE



WINE CABINET



DUAL ZONE

ADA MODELS AVAILABLE

BEVERAGE DISPENSER



DUAL TAP

BEVERAGE CENTER



ADA MODELS AVAILABLE

REFRIGERATOR DRAWER



ADA MODELS AVAILABLE

OWN THE OUTDOORS

True Residential refrigerators bring the performance and quality of commercial refrigeration not only to home kitchens but also to outdoor entertaining spaces. Handcrafted in the USA with the meticulous attention to quality and detail that industry professionals demand, True Residential is beloved by discerning architects, designers, and homeowners.

We design every refrigerator with a “point of use” philosophy, which means that where food and drink are enjoyed is where food and drink should be stored, and for many of us, that’s outdoors. From refrigerator drawers to beverage dispensers, every True product performs as well in your poolside cabana, BBQ center, or desert patio as it does in your indoor kitchen.

You might say that we overbuilt for the outdoors. From commercial-grade gaskets to high-density, fully foamed cabinets to countless other design details, there are hundreds of reasons that True is the preferred brand of outdoors-loving homeowners and specifiers around the world. With the industry’s best warranty, custom finishes, and the engineering to stand up to mother nature, True outdoor refrigeration gives you the freedom to enjoy all of life, wherever you live it.

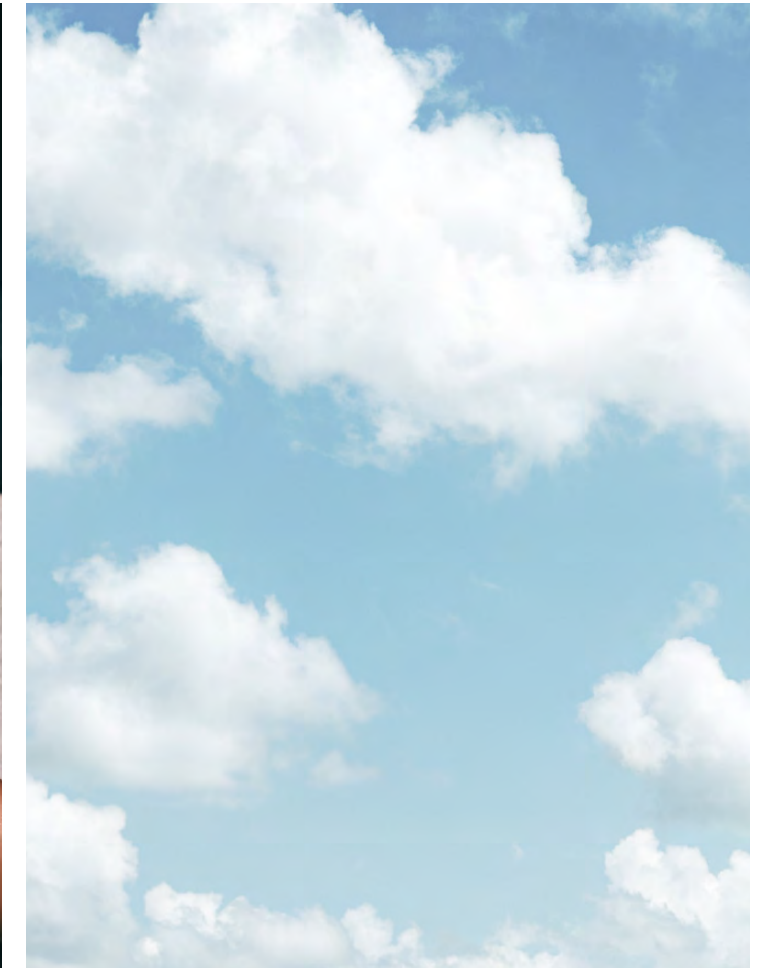

24" Refrigerator Drawer / 15" Clear Ice Machine / 24" Beverage Center / 15" Beverage Dispenser Custom Color Match / Chrome

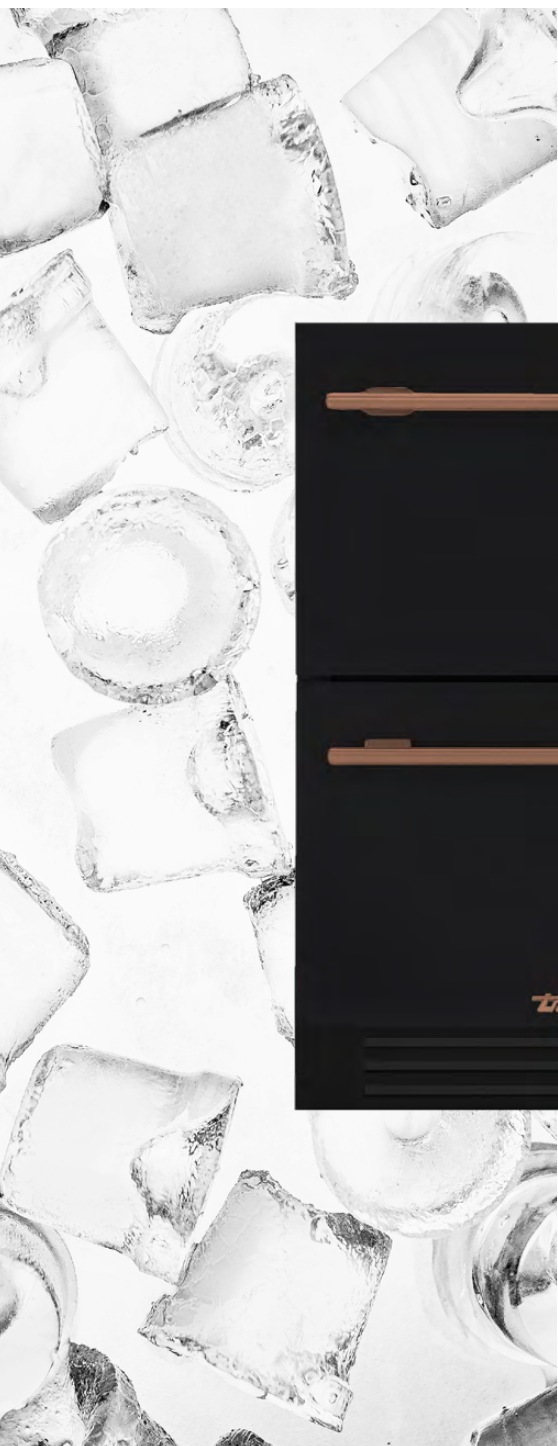

THE TRUE DIFFERENCE

300-SERIES STAINLESS

interior and exterior stand up against the most extreme elements and the most variable climates

DOUBLE PANE GLASS

is UV-tinted and low-e for additional protection

HEAVY-DUTY SEALS

protect perishables thanks to True commercial-grade gaskets

COMMERCIAL ENGINEERING

ensures temperature recovery and stability for the coldest temperatures in the hottest environments

DESIGN YOUR SPACE

with 15" and 24", glass and solid door, stainless steel, overlay panel, and custom finishes, all UL Rated for Outdoor Use

FORCED-AIR REFRIGERATION

brings product temperature down quicker and holds it there

TEMPERATURE STABILITY

from high-density foam-insulated doors and cabinets

INDUSTRY'S BEST WARRANTY

3 year full; 6 year sealed system, parts, labor; 12 year sealed system, parts for registered products (Clear Ice Machine is 3-year, 6-year only)

24" Freezer Drawer / 24" Dual Tap Beverage Dispenser Matte White / Pewter

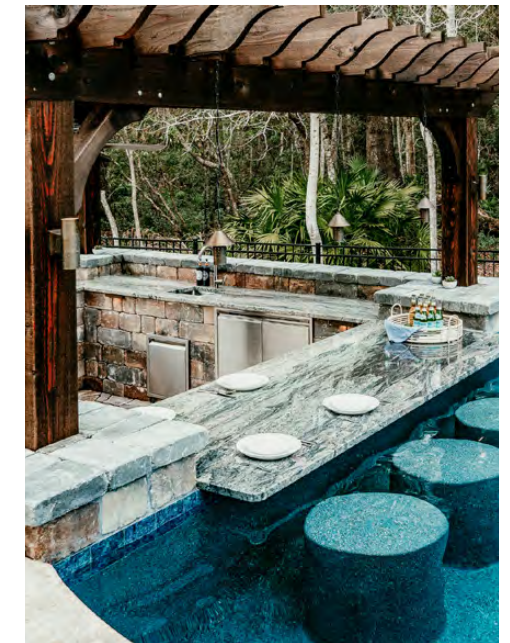

IN THE CLEAR

Clear skies. Clear schedule. Clear head. Nothing refreshes like a long day outdoors with family, friends, and the food and drink we gather around. This is why every True undercounter refrigerator is UL-rated for outdoor use—because the outdoors are essential to a full life.

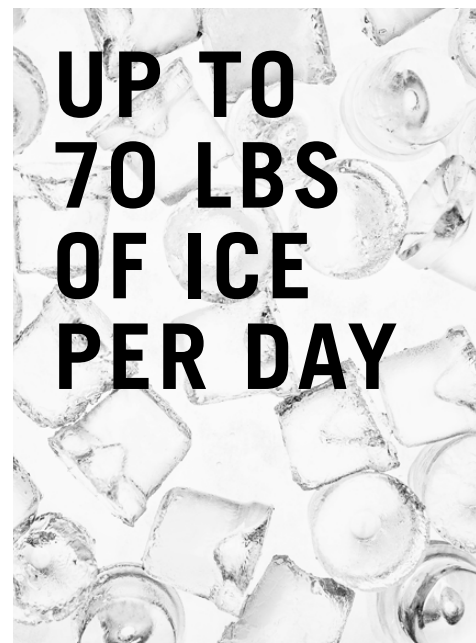

This is why we designed the Clear Ice Machine to produce up to 70 pounds of large, slow-melting, crystal clear cubes per day—more than any other residential ice machine—so that your outdoor entertaining is stress free, laughter full, clear sailing.



THE TRANSFER

Balancing family, work, and play, your plate is full. Now add to that plate financial planning, an upcoming vacation, and the dog (or your daughter's new boyfriend). Most likely there's more. Much more. Your plate is officially full.

We design refrigeration products. During design, we keep in mind the words of architect Eliel Saarinen: "Always design a thing by considering it in its next larger context—a chair in a room, a room in a house, a house in an environment, an environment in a city plan." This means that we design refrigerators not only with food and drink in mind; we also design with the eater and drinker in mind. We design for people whose lives—and hands—are full. We design with the conviction that if it's not simple, efficient, seamless, or streamlined, it has no place in your house.

At True, we talk about "the transfer," that place between where you are and where you want to be. For a lot of our customers, that

means the point between where food and drink are stored and where food and drink are enjoyed. That point usually ends up being a combination of narrow doorways, steps, or high-tension patio doors. During our design process, we talked a lot about those places, those transfer points. We discussed the benefits, for example, of refrigerating your marinating proteins right next to your grill. We knew that we needed to make the process of enjoying food simpler, so we made our refrigerators to work as well on your custom patio as in your kitchen, to stand both the test of time and the test of "the transfer."

So no more balancing act with a cutting board full of cheese and two wine glasses in-hand. No more hoping the dog (or the daughter's boyfriend) doesn't turn the corner just as you're passing through with a plate full of porterhouse. Eliminate the transfer; keep your food and drink where you want to enjoy it, and for many of you, that means the patio, the deck, that new outdoor kitchen space you've been planning on.



24" Freezer Drawer / 24" Beverage Dispenser Stainless Solid



24" Beverage Center Stainless Glass / 24" Refrigerator Stainless Glass / 24" Beverage Dispenser Stainless Solid

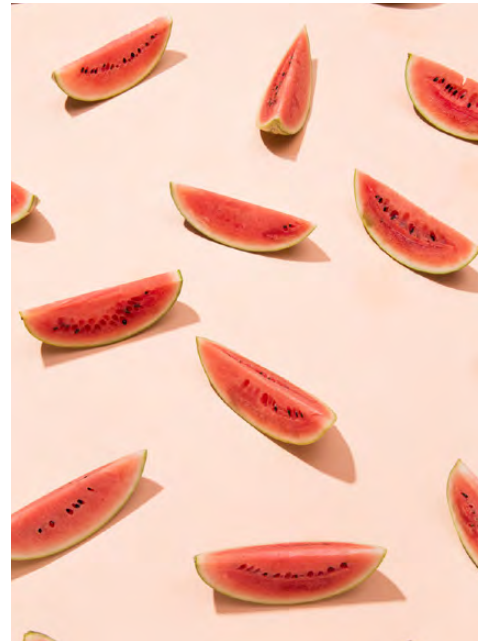

THE PERFECT SERVE

Beverage connoisseurs from Portland, Oregon to Portland, Maine are passionate in their praise of the True Beverage Dispenser, not only for its good looks but also for its precision and consistency.

Whether it's late November or the dog days of summer, you get the same perfect serve every time: a consistently frosty, refreshing beverage pulled perfectly to 33° as it passes through our air-cooled tower and into your pint glass. Single tap or dual tap, boasting beer or cold brew, your True Beverage Dispenser is precise, consistent, and ready for whatever's on tap.



OUTDOOR LIVING ALWAYS ON TAP

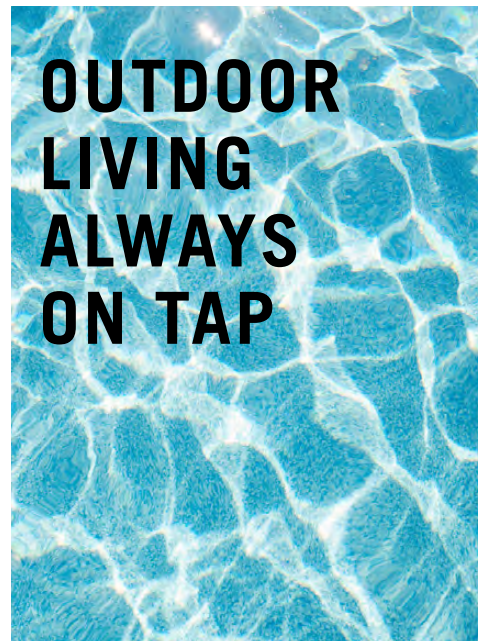

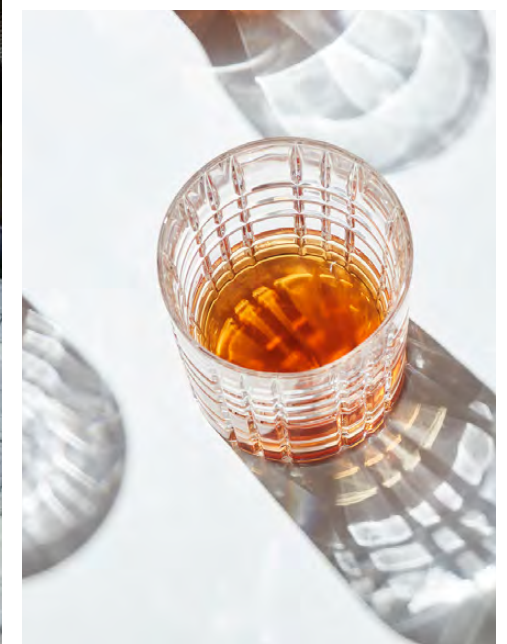
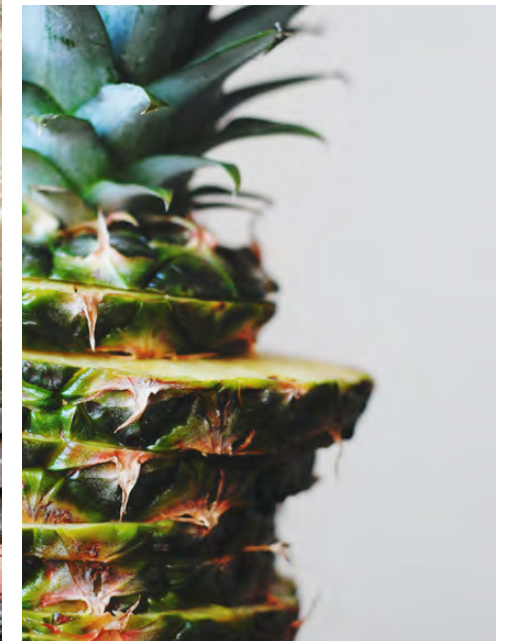











24" Refrigerator Stainless Glass / 15" Clear Ice Machine Stainless Solid

Project Design + Buildout by Pratt Guys

CUSTOM COLORS

				
MATTE WHITE	ANTIQUÉ WHITE	SAFFRON	EMERALD	COBALT
COLOR NUMBER 030	COLOR NUMBER 050	COLOR NUMBER 103	COLOR NUMBER 086	COLOR NUMBER 078
				
				
JUNIPER	ULTRA MATTE BLACK	MATTE BLACK	GLOSS BLACK	
COLOR NUMBER 104	COLOR NUMBER 085	COLOR NUMBER 027	COLOR NUMBER 044	
				

CUSTOM HARDWARE

				
CHROME	GOLD	BRASS	COPPER	PEWTER
COLOR NUMBER H02	COLOR NUMBER H08	COLOR NUMBER H01	COLOR NUMBER H03	COLOR NUMBER H05
				



PLAN VIEWS AND DIMENSIONS

15 INCH

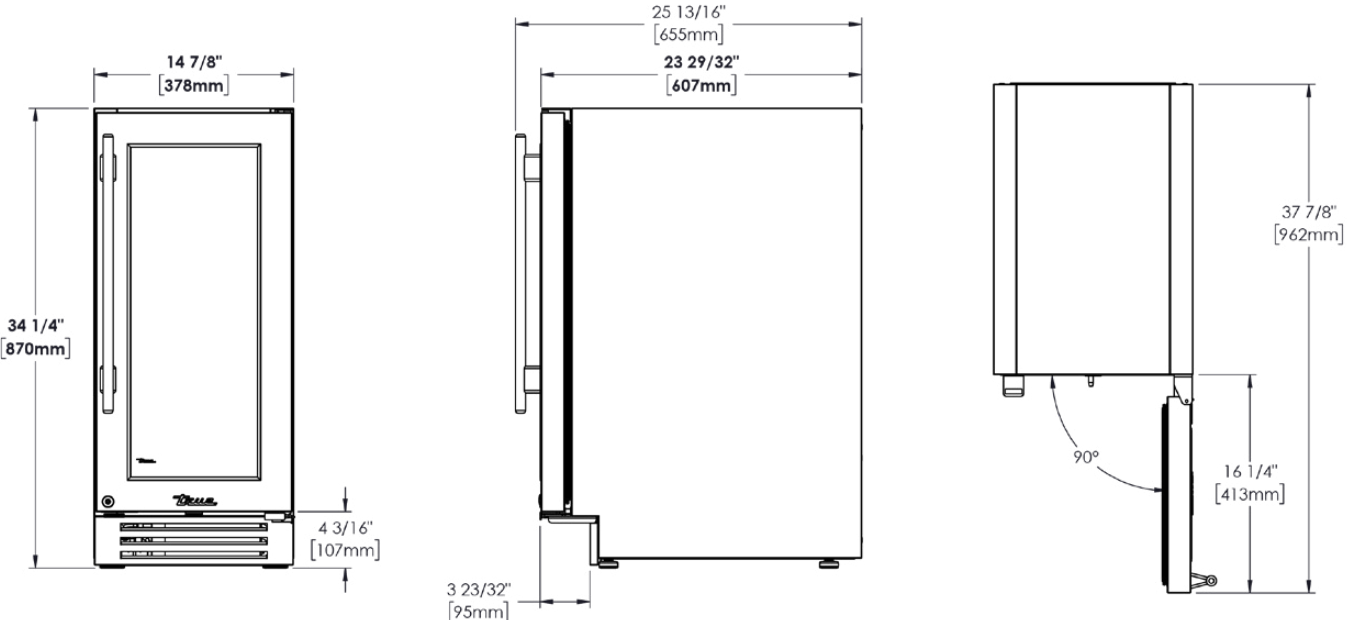

24 INCH

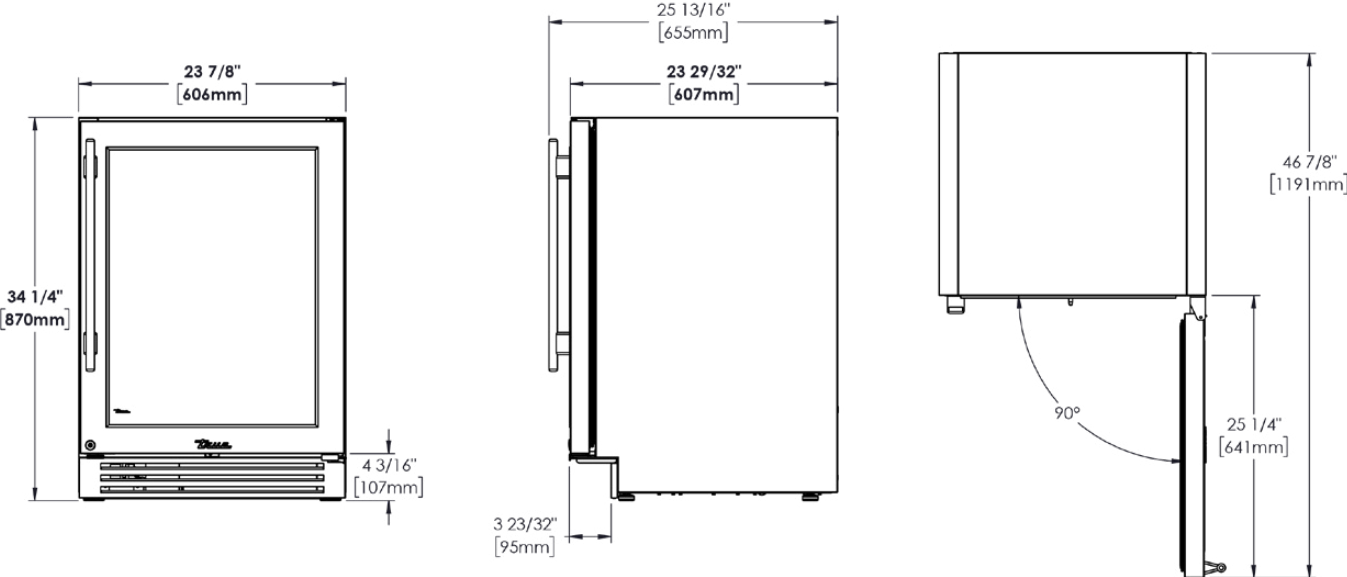

24" Freezer Drawer / 24" Beverage Dispenser Stainless Solid



24" Beverage Center Stainless Glass

INDUSTRY'S BEST WARRANTY INDOORS AND OUT

- 3 YEAR** | Full
- 6 YEAR** | Sealed System - Parts & Labor
- 12 YEAR** | Sealed System - Parts*

*Parts only when registered; excludes Clear Ice Machine



(636) 240-2400 · Toll Free (888) 616-8783

info@true-residential.com

TRUE-RESIDENTIAL.COM