



INSTRUCTIONS D'ASSEMBLAGE
ASSEMBLY INSTRUCTIONS

MONARCH
SPECIALTIES INC.

I 7795

BUREAU -
42" L / FAUSSE PIERRE GRISE / METAL NOIR

COMPUTER DESK -
42" L / GREY STONE-LOOK / BLACK METAL



**POUR DE L'ASSISTANCE OU POUR COMMANDER
DES PIÈCES CONTACTEZ NOTRE DÉPARTEMENT
DE SERVICE À LA CLIENTÈLE.**

**FOR ASSISTANCE OR TO ORDER PARTS
CONTACT OUR CUSTOMER SERVICE DEPARTMENT**

WWW.MONARCHSERVICE.COM

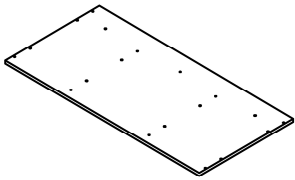
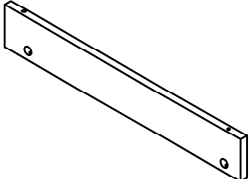
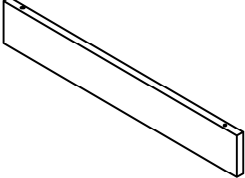
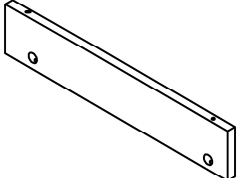
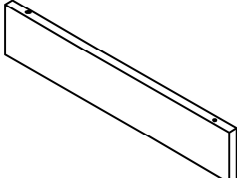

LISTE DES PIÈCES
PARTS LIST

PIÈCE / PART #	IMAGE	DESCRIPTION	QTY / QTÉ
1		DESK TOP SURFACE DU BUREAU	1
2		FRONT FACING LEFT SIDE PANEL PANNEAU DE CÔTÉ GAUCHE	1
3		FRONT FACING RIGHT SIDE PANEL PANNEAU DE CÔTÉ AVANT DROIT	1
4		SUPPORT PANEL PANNEAU DE SOUTIENT	1
5		SUPPORT PANEL PANNEAU DE SOUTIENT	1

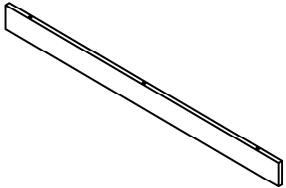
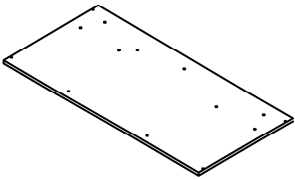
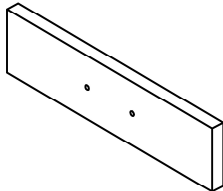
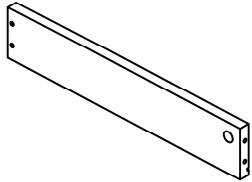
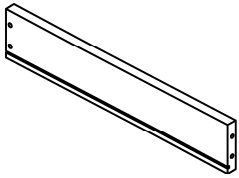
LISTE DES PIÈCES
PARTS LIST

PIÈCE / PART #	IMAGE	DESCRIPTION	QTY / QTÉ
6		BACK PANEL PANNEAU ARRIÈRE	1
7		BOTTOM PANEL PANNEAU DU BAS	1
8		DRAWER FRONT PANEL PANNEAU AVANT TIROIR	2
9		DRAWER SIDE PANEL PANNEAU DE CÔTÉ TIROIR	2
10		DRAWER SIDE PANEL PANNEAU DE CÔTÉ TIROIR	2

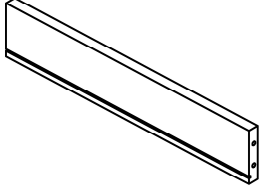
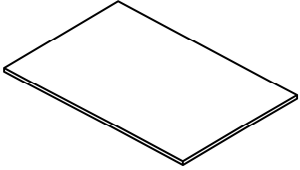
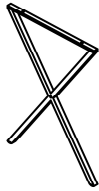
LISTE DES PIÈCES
PARTS LIST

PIÈCE / PART #	IMAGE	DESCRIPTION	QTY / QTÉ
11		DRAWER BACK PANEL PANNEAU ARRIÈRE TIROIR	2
12		DRAWER BOTTOM PANEL PANNEAU DU BAS TIROIR	2
13		METAL LEG PATTE EN METAL	2
14		STRETCHER CHÂSSIS	2

LISTE DES PIÈCES DE MONTAGE
HARDWARE LIST

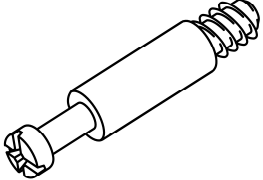
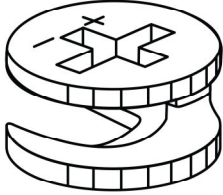
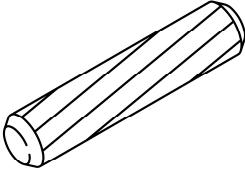
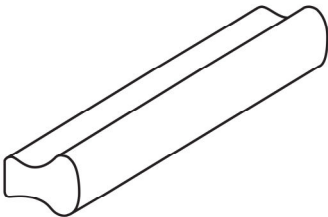
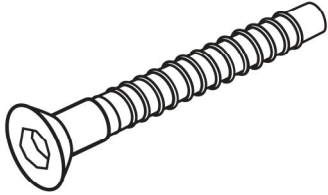
PIÈCE / PART #	IMAGE	DESCRIPTION	QTY / QTÉ
A		CAM LOCK SCREW VIS CAM LOCK	12
B		CAM LOCK CONNECTOR ÉCROU CAM LOCK	12
C		WOOD DOWEL GOUJON DE BOIS	22
D		HANDLE POIGNÉE	2
E		ASSEMBLING SCREW - Ø1/4" X 1 3/8" VIS D'ASSEMBLAGE - Ø1/4" X 1 3/8"	8

LISTE DES PIÈCES DE MONTAGE
HARDWARE LIST

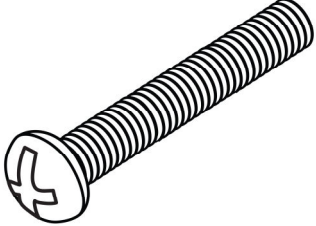
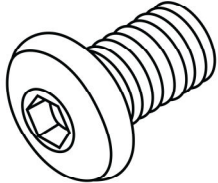
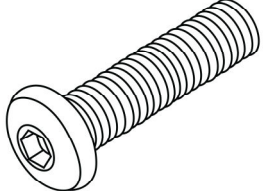
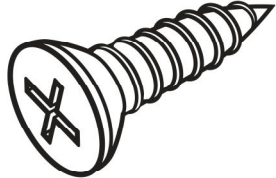
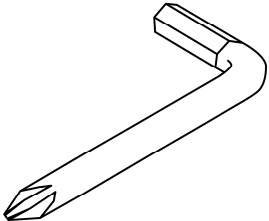
PIÈCE / PART #	IMAGE	DESCRIPTION	QTY / QTÉ
F		ASSEMBLING BOLT - Ø1/8" X 5/8" BOULON D'ASSEMBLAGE - Ø1/8" X 5/8"	4
G		ASSEMBLING BOLT - Ø1/4" X 1/2" BOULON D'ASSEMBLAGE - Ø1/4" X 1/2"	4
H		ASSEMBLING BOLT - Ø1/4" X 3/4" BOULON D'ASSEMBLAGE - Ø1/4" X 3/4"	4
I		ASSEMBLING SCREW - Ø1/8" X 1 1/8" VIS D'ASSEMBLAGE - Ø1/8" X 1 1/8"	8
J		HEX KEY CLÉ HEXAGONALE	1

LISTE DES PIÈCES DE MONTAGE
HARDWARE LIST

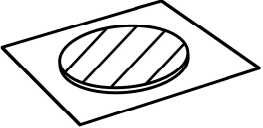
PIÈCE / PART #	IMAGE	DESCRIPTION	QTY / QTÉ
K		FINISHING STICKER COLLANT DE FINITION	12



OUTIL DE VÉRIFICATION DE DIMENSIONS DES PIÈCES
HARDWARE DIMENSIONS VERIFICATION TOOL



ÉTAPE / STEP 1

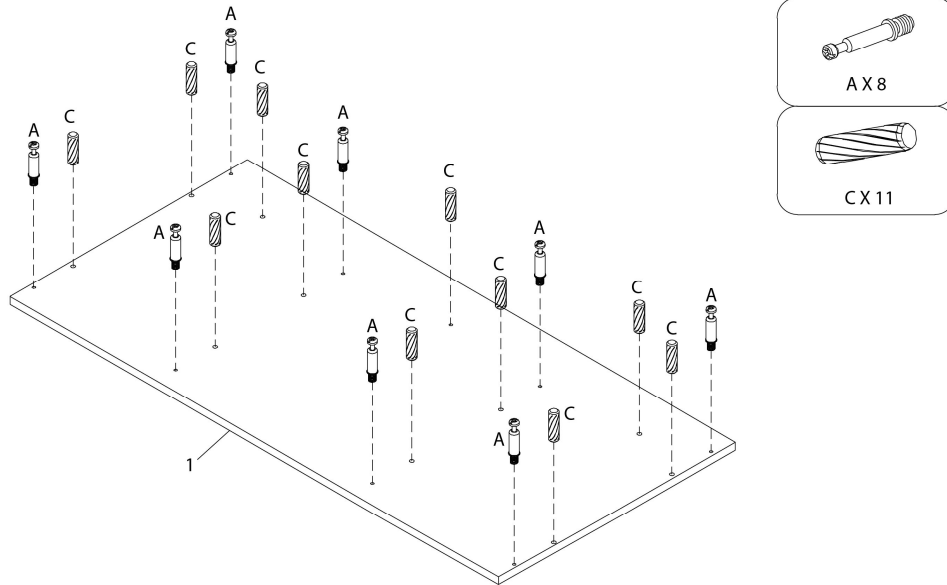

ÉTAPE / STEP 2

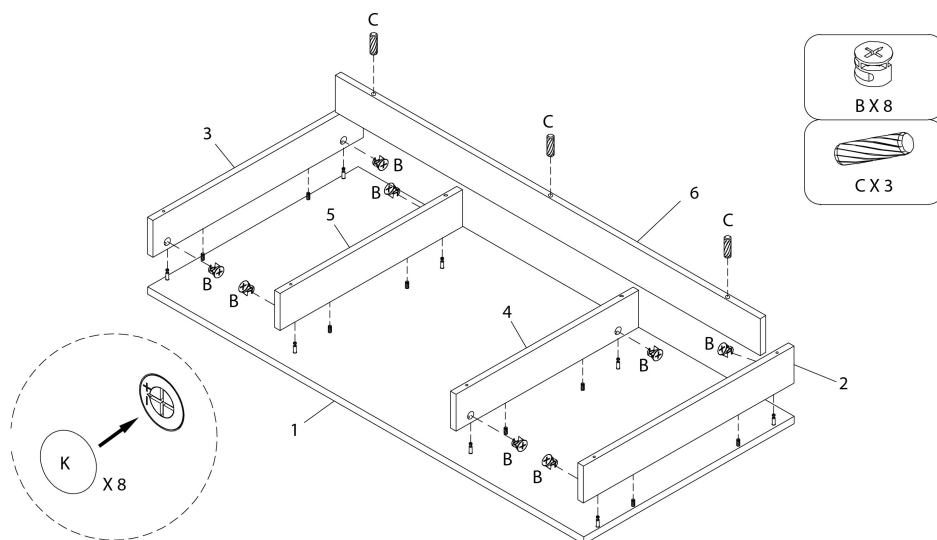

ÉTAPE / STEP 3

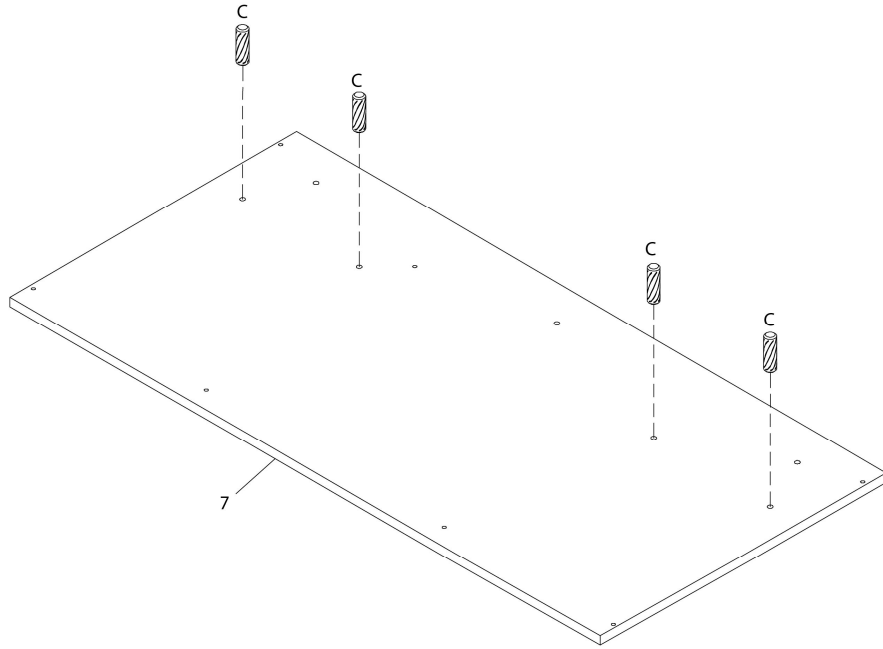

ÉTAPE / STEP 4

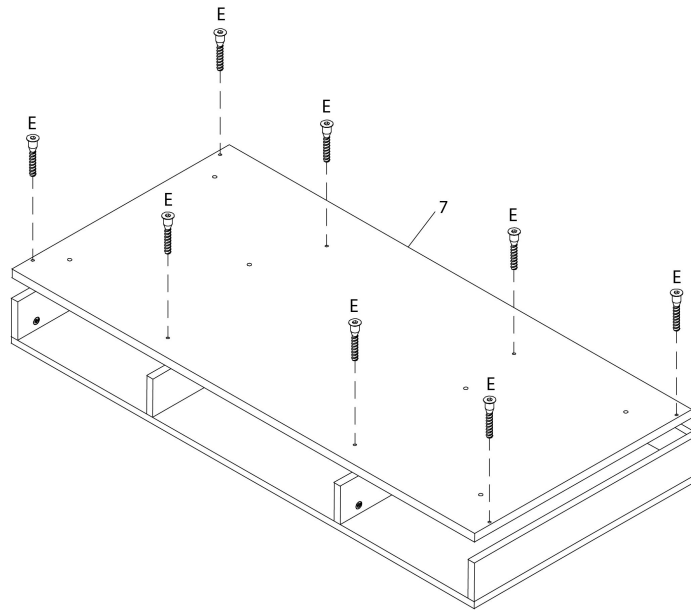

ÉTAPE / STEP 5

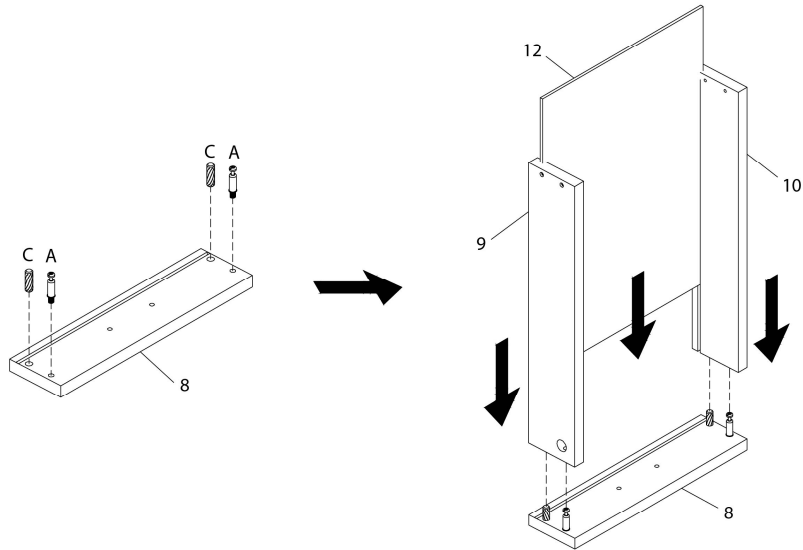

X 2

ÉTAPE / STEP 6

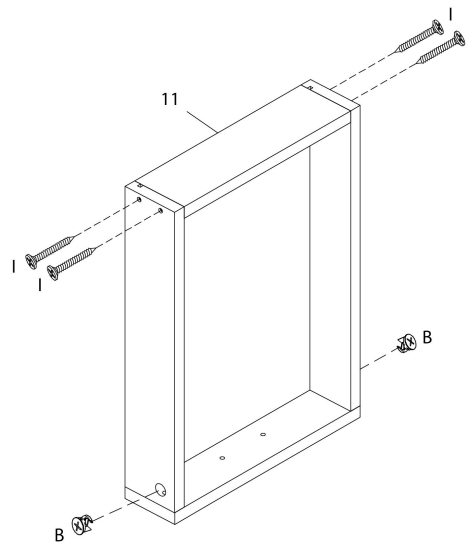

X 2

ÉTAPE / STEP 7

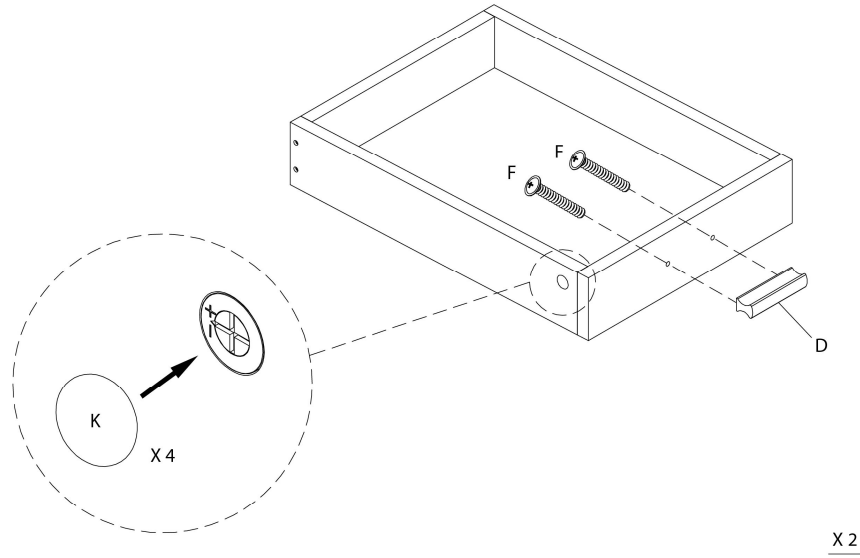

ÉTAPE / STEP 8

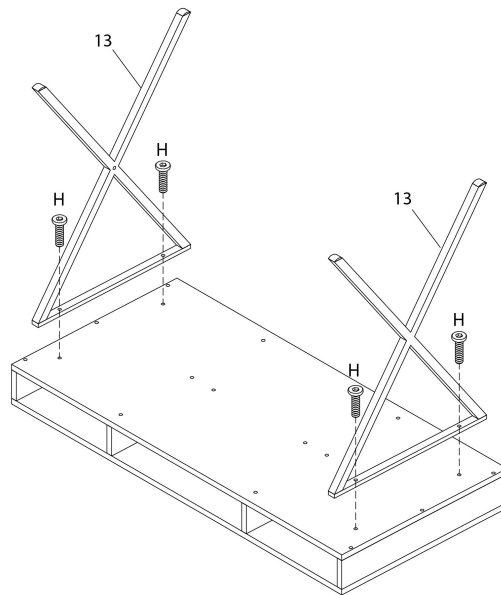

ÉTAPE / STEP 9

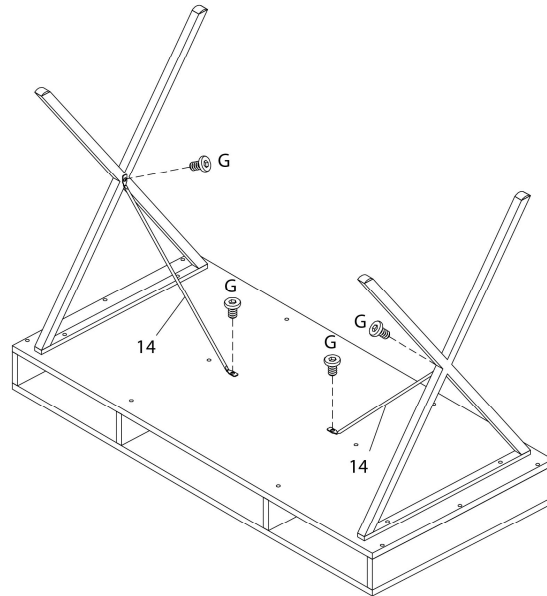

ÉTAPE / STEP 10

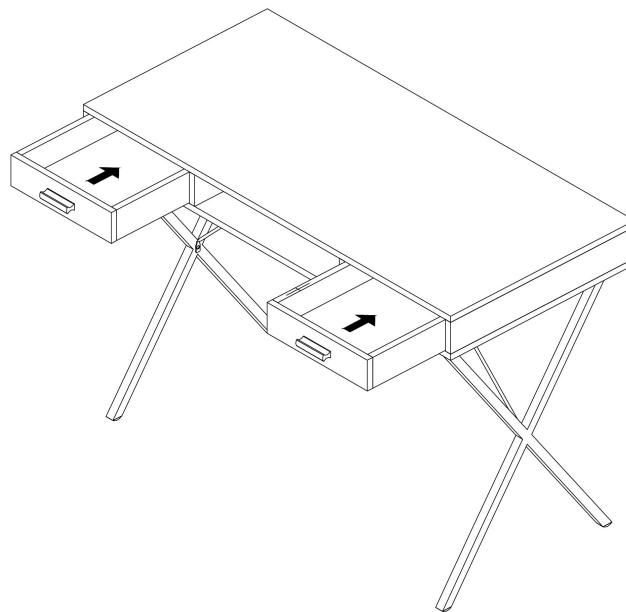

ÉTAPE / STEP 11

